

TECHNICAL NOTE

European XFEL

Post-TDR Description

February 2013

W. Decking and T. Limberg
for the DESY XFEL Project Group

European X-Ray Free-Electron Laser Facility GmbH

Albert-Einstein-Ring 19

22761 Hamburg

Germany



Contents

1	Introduction	3
2	Design Changes	4
2.1	Injector and Bunch Compression System	4
2.2	Changed Injector and e-Beam Parameters	5
2.3	Linac	6
2.3.1	Tunnel Temperature Stabilization	7
2.4	Undulator Position and Lengths	8
3	Regions and Components	10
3.1	Laser Heater	10
3.2	Bunch Compression Chicanes	10
3.3	Collimation and Feedback Section	12
3.3.1	Collimator	12
3.3.2	Collimator Section	12
3.4	Diagnostics	13
3.5	Pulse Repetition Rate, Bunch Frequencies and Patterns and Beam Distribution	14
3.6	Personal Protection System (PPS)	17
4	Upgrades	18
4.1	X-ray FEL Upgrades	18
4.1.1	Seeding schemes	18
4.1.2	Harmonic Lasing	18
4.1.3	Circular Polarization	19
4.2	Beam Parameter Variations along Bunch Train	20
4.2.1	Electron Beam Optics	20
4.2.2	rf System Regulation	20

1 Introduction

This document lists and describes design changes of the European XFEL with respect to the Technical Design Report (TDR), points out regions or components which are worked out and documented in much more detail than in the TDR and, finally, gives an overview of possible upgrades which are presently discussed.

We go through these points and describe them briefly and compile a list which points to the EDMS identifiers of the detailed documents.

2 Design Changes

2.1 Injector and Bunch Compression System

The design of the bunch compression system was changed for the sake of necessary cost-savings: the 3rd harmonic rf system is reduced in strength and length by a factor of three and moves into the injector building. That makes an additional bunch compression chicane (named BC0) at the end of the dogleg necessary.

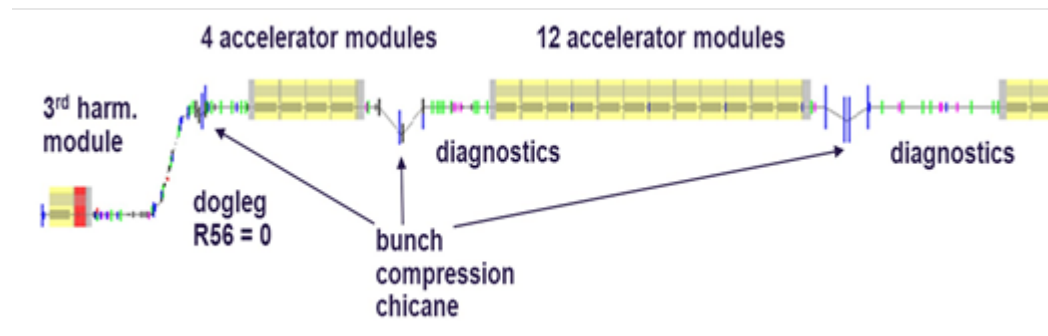

Fig. 1: Side view of the Injector-Bunch Compression area

Table 1: New R56 ranges and beam energy settings (Ref. 1)

	R56 range [mm]	Bending Angle [deg]	B _{min} [T]	B _{max} [T]
BC0 (130 MeV)	0, 30–90	0, 5.67–9.82	0, 0.08	0.149
BC (700 MeV)	20–80	1.93–3.86	0.16	0.31
BC2 (2.4 GeV)	10–60	1.36–3.34	0.38	0.93

Owing to the fact that the beam has to traverse the dogleg with a considerable energy chirp, the optical design of the dogleg had to be redone in order to improve its chromatic properties (Ref. 21).

2.2 Changed Injector and e-Beam Parameters

Different from table 4.3.1 in the TDR all cavities of the first rf module are run at the same gradient of about 18 MV/m. The beam energy downstream of the 3rd harmonic rf system is about 130 MeV.

More important, recent measurements at the Photo-Injector Test Stand in Zeuthen (PITZ) and the experiences with beam transport at the LCLS prompted a revision of e-beam parameters and charge scope (Ref. 2).

Table 2: Modified parameter set for the e-beam

	TDR	New Parameter Set
Electron Energy	17.5 GeV	10.5/14/7.5 GeV
Bunch charge	1 nC	0.02–1 nC
Peak current	5 kA	5 kA
Slice emittance	< 1.4 mm mrad	0.4–1.0 mm mrad
Slice energy spread	1.5 MeV	4–2 MeV
Shortest SASE wavelength	0.1 nm	0.05 nm
Pulse repetition rate	10 Hz	10 Hz
Bunches per pulse	3000	2700

The new parameter set enlarges the photon energy range of the facility (Fig. 2, Ref. 9), but puts a strain on different sub-systems, especially for operation with very low charge. All beam diagnostics are affected as well as the rf stabilization and the beam-stabilizing feedback systems.

As a rule, we extended the 1 nC-case specifications down to 0.1 nC and set a limit to the deterioration in performance for even lower charges (see for instance Ref. 3).

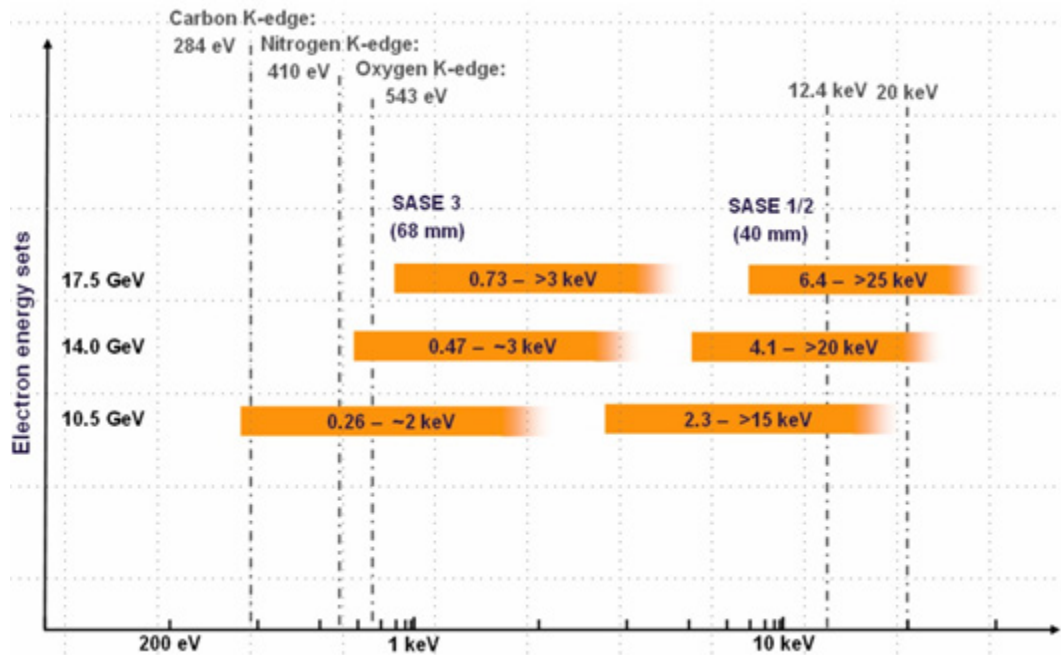

Fig. 2: Photon energy range of the European XFEL

2.3 Linac

In the TDR the XFEL main linac consisted of 100 modules installed downstream of the last bunch compressor, yielding a maximum energy of 20 GeV. The operating energy of 17.5 GeV could be reached with a gradient of 20.3 MV/m and two RF stations (8 modules) off. Due to financial reasons the number of modules was reduced to 84, reaching the operating energy of 17.5 GeV at a gradient of 23.4 MV/ m with one RF station (4 modules) off.

The tunnel and lattice layout leaves space for the installation of 12 additional modules.

The repetition rate was changed from 5 MHz to 4.5 MHz in order to be compatible to FLASH-I/II.

Table 3: Linac RF parameters

Quantity	TDR Parameters	New Parameters
electron energy	17.5/20 GeV	10.5/4/17.5 GeV
macro pulse repetition rate	10 Hz	10 Hz
RF pulse length (flat top)	600 μ s	600 μ s
bunch repetition frequency within pulse	5.0 MHz	4.5 MHz
beam power	550 kW	500 kW
# of 1.3 GHz modules		
Injector	1	1
Linac 1	4	4
Linac 2	12	12
Linac 3	100	84
accelerating gradient for 17.5 GeV	20.3 MV/m (with 8 modules off)	23.4 MV/m (with 4 modules off)
# of 10 MW multi-beam klystrons	30	26
average klystron power (for 0.03 mA beam current at 17.5 GeV)	5.2 MW	5.2 MW

2.3.1 Tunnel Temperature Stabilization

Careful modeling of temperature distribution before and after interrupting rf operation, for instance for machine access, showed that the recovery time to a stable temperature profile is too long. In the transition time, rf stability will be low and tuning will be difficult if not impossible.

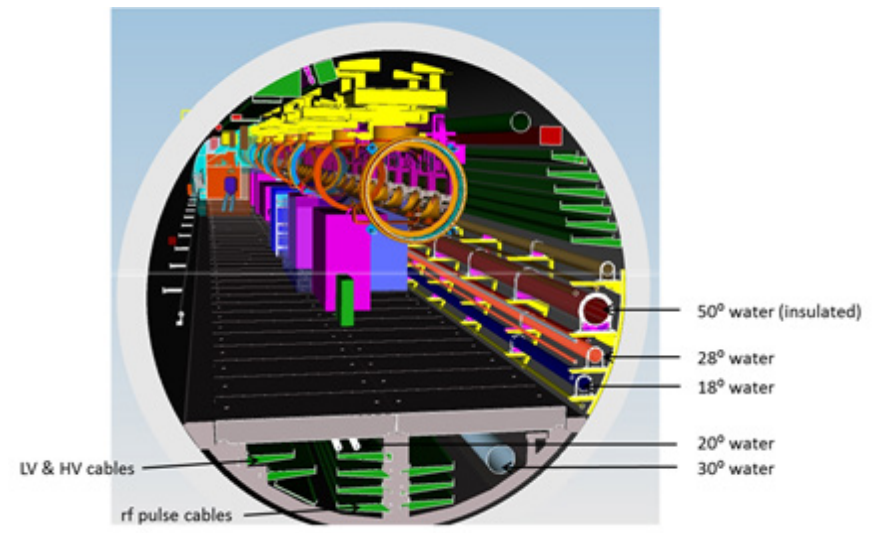

Fig. 3: Component temperatures and heat loads entering temperature simulations of the XFEL linac tunnel.

A distributed electric heating system will be installed which relatively precisely replaces the heat impact of the rf system if that is switched off (Ref. 8). This system reduces the temperature change to less than a degree Celsius, as specified by the rf regulation.

2.4 Undulator Position and Lengths

Changes of the layout for undulators SASE 1 and SASE 2 (Ref. 4): The beginning of SASE2 is moved downstream by 26.6 m, leaving additional space of 46.6 m for seeding and/or other beam manipulation schemes in the tunnel and shaft. At the proposed undulator length (see below) behind the undulator space remains for 18 undulator segments.

The beginning of SASE 1 is moved downstream by 66.6 m to match the distance from the undulator to the following electron bend.

Both undulator FODO channels shall be of the same length of 35 half cells equipped with undulators and intersections.

The layout of undulator SASE 3 is not changed.

Table 4: Start and end positions, # of undulator units and available space for future upgrades

	Start Undulator	Maximum extension	# of FODO half cells equipped	Maximum possible # of FODO half cells
SASE 1	2238	2564	35	53
SASE 2	2198	2524	35	53
SASE 3	2797	3026	22	37 (65 if extended upstream)

Source Point Position:

The x-ray source position has been defined now to be about 15 m before the end of the undulators. Since the source position determines the photon beam transport and, in particular, the focusing schemes and therefore the focal spot sizes at the instruments, this source position shall be kept as fix as possible. This requires different undulator settings for FEL operation with different saturation length, e.g. for different photon energy or using different bunch charge. Also the future implementation of self- seeding shall respect this requirement.

3 Regions and Components

3.1 Laser Heater

In the laser heater, a laser beam traveling with the electron beam through an undulator magnet increases the width of the energy distribution of the electrons, thus damping the so-called ‘micro-bunching’ instability. In Fig. 4, four (grey) dipole magnets form a chicane to align the laser with the e-beam, the undulator (yellow) in their midst.

The laser heater is a contribution in kind by the *Vetenskapsrådet* (Swedish Research Council) (see Ref. 7).

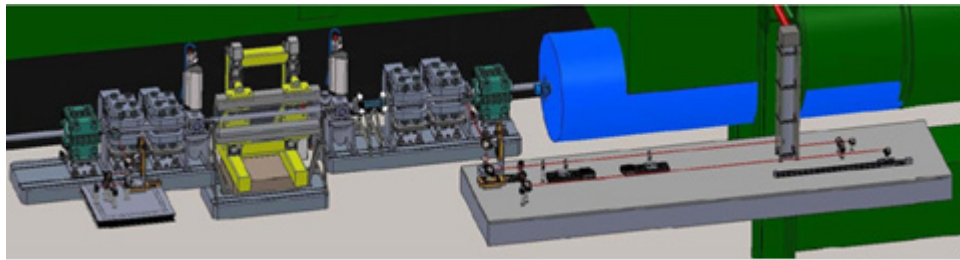

Fig. 4: 3-D model of the Laser Heater

3.2 Bunch Compression Chicanes

Fig. 5 shows a technical drawing of a bunch compression chicane. They all consist of four dipole magnets with wide gaps and a vacuum chamber with a width of 400 mm, so that different settings for the longitudinal dispersion R_{56} can be achieved without mechanically moving parts (Ref. 1).

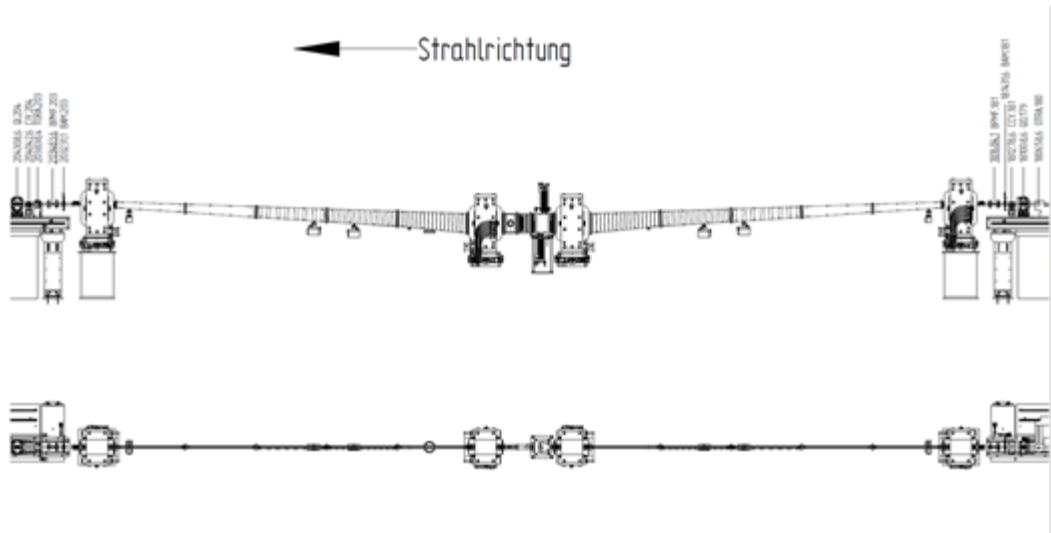

Fig. 5: Side view and top view of the XFEL bunch compressor chicane BCI



Fig. 6: Photo of an XFEL bunch compressor chicane dipole magnet

3.3 Collimation and Feedback Section

3.3.1 Collimator

Collimator design for the European XFEL is done. The device is in the prototyping stage at the BINP. Different collimation apertures can be moved into the path of the beam.

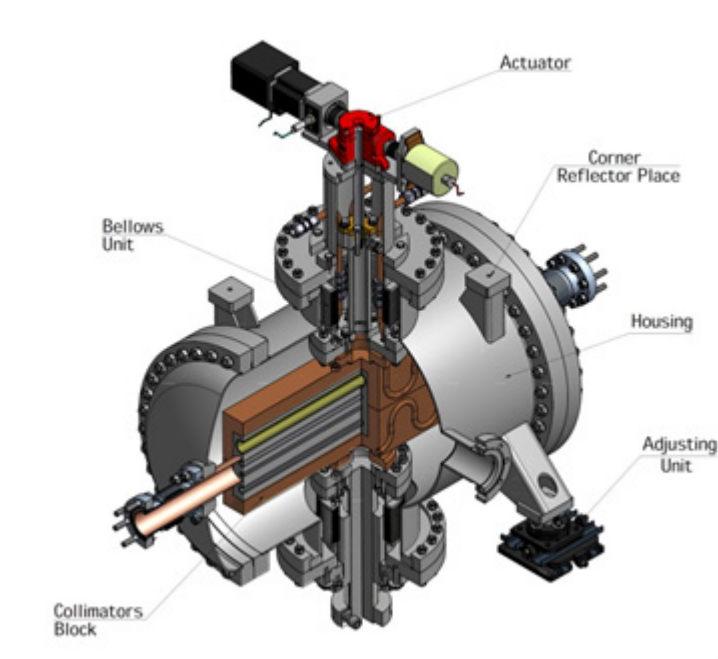

Fig. 7: Collimator for the XFEL

Collimators will be installed in the bunch compression magnet chicanes to assist energy collimation.

3.3.2 Collimator Section

The present layout of the collimation section allows for very flexible beam optics (Ref. 6). Beta function variation by adjusting matching and phase shifter quadrupole magnets can accommodate low tolerance optics for commissioning, beam measurements and fine tuning of energy and amplitude collimation depth.

Vertical adjustments of the magnets can be used to vary the longitudinal dispersion R_{56} between 1 mm and -1 mm.

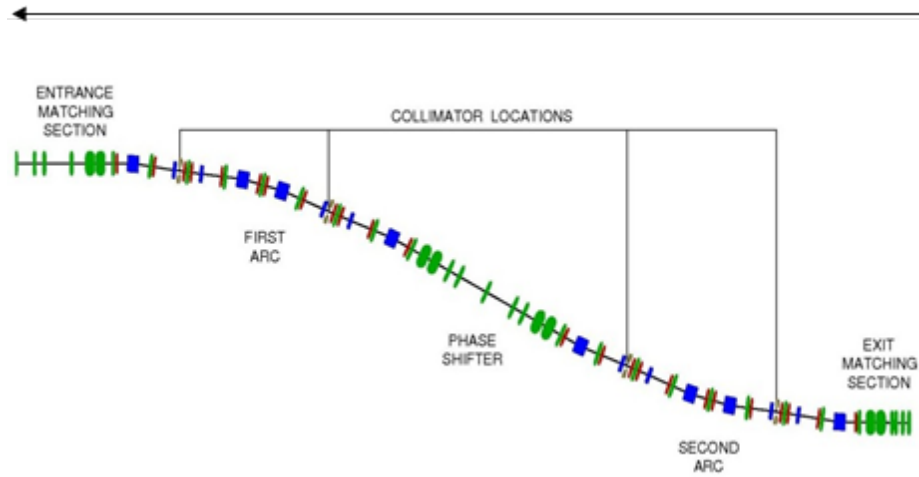

Fig. 8: Side view of the 'dog leg', where the electron beam collimators are positioned. The vertical height is about 2.5 m

3.4 Diagnostics

The diagnostic system is now expected to perform for a bunch charge range from 0.02 nC to 1 nC. The performance of the different components will fulfill the original specifications between 0.1 nC and 1 nC. At lower charges, BPM resolution will get worse by a factor of 2 ('knob' BPMs) to 5 (cavity BPMs), beam profile measurements should not be affected.



Fig.9: Upper row: *Beam Position Monitor, Charge monitor, dark current monitor.*
 Lower row: *Screen monitor, transverse deflecting rf structure, beam loss monitor*

All diagnostic components are prototyped or in pre-series, detailed descriptions in Ref. 10-15.

3.5 Pulse Repetition Rate, Bunch Frequencies and Patterns and Beam Distribution

The RF pulse repetition rate is 10 Hz. Many systems are laid out to also work at 25 Hz for a future upgrade. Operation at 25 Hz might require lowering the pulse length. In addition, an upgrade of the electron gun cooling capabilities is required.

The bunch repetition frequency within the RF pulse is $n \cdot 111$ ns resp. 9 MHz/ n with $n \geq 2$. This bunch pattern will be produced by the gun laser. Table 5 gives an overview of initially available modes.

Table 5: Bunch patterns as produced by the injector laser

n	bunch spacing [ns]	bunch repetition frequency [MHz]	bunches in 600 /ls train ¹
2	222	4.5	2700
9	1000	1	600
90	10000	0.100	60
–	–	–	1

In the TDR, the operation of the XFEL foresees a constant beam loading in the linac, i.e., a train of bunches is with equal bunch spacing and charge. Bunch distribution into the two beam lines Elbe (SASE2, ...) and Alster (SASE1, SASE3) is obtained with a 10 Hz repetition rate flat top kicker that essentially divides the bunch train in two parts, the first being distributed into the Alster branch. A fast bunch kicker is capable of aborting single bunches out of a pulse into a dedicated beam dump before the separation in the Elbe and Alster branches.

Although this system is very flexible, certain restrictions apply:

- Each dump is rated to 300 kW or approx. 1700 bunches at 1 nC.
- The fast kicker can only kick up to 1500 bunches per 10 Hz pulse.
- Diagnostic, feedback and machine protection systems need to get information about the bunch pattern well in advance of every pulse. The distribution of this information will be handled by the timing system (Ref. 19).

SASE3 was foreseen to use the spent beam from SASE1 for lasing. This connects the radiation performance of SASE3 to the operation mode of SASE1 and might at certain conditions even prevent lasing in SASE3.

¹ Number of bunches in the train can be reduced by shortening the laser burst.

A more independent operation of SASE3 is possible with bunches that have not lased in SASE1. This can be achieved by:

- Opening the SASE1 undulator (very slow)
- Applying a DC bump with standard steering magnets (10 Hz switching frequency)
- Applying a fast orbit perturbation within a bunch to allow parts of the train to lase in SASE3 and others in SASE1. This could be achieved most easily with a dedicated fast kicker magnet in front of SASE1. This magnet is not part of the present XFEL hardware. Nevertheless, other means might be sufficient to achieve the same goal like the misuse of feedback kickers or beam distribution kickers or an energy change in connection with dispersive orbits in the undulator.

Because of the complex interplay of timing, feedbacks and machine protection systems the commissioning and development of the beam distribution is envisioned in stages with a first estimate of the elapsed time in between the stages

- 1 Distribution with a DC magnet and operation of one branch only.
- 2 Distribution with flat top kicker but no bunch pattern selection by fast kicker (1. + 12 month).
- 3 Bunch pattern selection for Alster and Elbe branch with fast kicker (1. + 15 month).
- 4 Operation of SASE3 with 'fresh' bunches (not defined yet).

3.6 Personal Protection System (PPS)

The personnel protection system has been detailed (Ref. 5). This includes the definition of accessible areas and access conditions and the design and later installation of the necessary hardware to secure the accessible areas from persons to enter or respectively beams to enter when people are present.

Some parts of the accelerator can be operated when downstream areas are accessed. Beam entering these areas is prevented by redundant deflecting systems, in general a combination of an electromagnet and a moveable permanent magnet. At the beginning of each photon beam line T6–T10 a permanent magnet dipole will be installed to prevent electrons to enter these beam lines.

4 Upgrades

4.1 X-ray FEL Upgrades

4.1.1 Seeding schemes

4.1.1.1 Self-Seeding

To provide self-seeding for an hard-X-ray FEL, a relatively simple scheme for was proposed: replace an undulator module with a magnet chicane which guides the electron beam around a crystal inserted into the straight-ahead path of the photon beam. The photon beam, after its spectral content is filtered by the crystal, seeds the FEL process in the following undulator modules, producing, at the undulator exit, an X-ray pulse with a much narrower spectrum than that of the un-seeded FEL.

The scheme has been successfully tested at the LCLS and is, appropriately modified, proposed for the European XFEL (Ref. 17).

For self-seeding in the soft X-ray regime, grating monochromators are used instead of the crystal(s). Tests are planned at the LCLS for August–September 2013, a similar scheme for the European XFEL is proposed (Ref. 18).

4.1.2 Harmonic Lasing

By suppressing the first harmonic wavelength of a SASE FEL, the third harmonic builds up to a strength comparable to the first. This could be exploited either to increase photon energy, or operate the European XFEL at beam energies low enough to allow cw-operation and still deliver 1 Å wavelength via the 3rd harmonic (Ref. 16).

4.1.3 Circular Polarization

There is the User Consortium proposal by the Budker Institute of Nuclear Physics (INP) to upgrade the SASE3 soft X-ray beam line with a set of afterburner electromagnetic undulators to provide variable polarization (linear and circular). This modification will allow studies of the electronic structure and excitations in solids and liquids as well as magnetism and magnetic structures, including their dynamics.

The upgrade will be compatible with the burst mode capability of the facility. Switching the polarization will be done on the train frequency level (5–10 Hz).

The consortium proposes the following deliverables

- Budker INP is going to provide an elliptically polarized electromagnetic undulator with fast polarization switching. The undulator will be installed downstream the SASE3 long undulator line and use a micro-bunched electron beam to generate coherent radiation.
- Budker INP is going to perform research and development of the separation of linear polarized radiation from the main long undulator and radiation from the elliptically polarized undulator.
- After approval of the feasibility study by XFEL.EU, Budker INP is going to send a separate proposal for the mechanical design, manufacturing, installation and commissioning of the separation system.
- Budker INP is responsible for the undulator commissioning. It includes achieving the project parameters of the undulator field and a reliable operation of the undulator on-site.

4.2 Beam Parameter Variations along Bunch Train

Varying electron beam parameters like charge, bunch length or energy within the bunch train is planned to be part of the machine development phase which follows the commissioning.

Different problems arise and are under study:

4.2.1 Electron Beam Optics

Bunches with different charge densities see different effective focusing, due to the space charge forces. That can result in beam loss and/or background problems. Furthermore, there is a given optimal beam envelope in the undulator to achieve maximum power in the SASE photon pulse. If the optics difference between the different bunch species becomes too big, only one of them will lase efficiently.

We are studying this problem, which is complicated by the fact that we are dealing with non-linear optic effects, with the help of start-to-end simulations (Ref. 20).

4.2.2 rf System Regulation

The rf system regulation must cope with a bunch train, which, different to section 3.5, does not have constant beam loading along the rf pulse. Furthermore, rf phases and amplitudes have to be changed on very short time scales to allow for different bunch lengths or energies along the train. Studies at FLASH are under way to explore the practicability of this approach.

A Reference Documents and EDMS Identifiers

Ref. #	Subject	Title of Note	EDMS ID or other reference
1	BC Chicanes	Bunch Compressor Chicane Specification	D00000001658531
2	e-Beam Parameters	Baseline Electron Beam Parameters	D00000003317421
3	BPM Specification	Performance Specifications for the European XFEL BPM System	D00000001767781 D00000002604261
4	Change Request of Undulator Beam Line Layout	SASE and SASE2 position and length change	D00000002031861
5	Personal Interlock	Personal Interlock Beam Line Components	D00000002795141
6	Collimation Section	V.Balandin, R.Brinkmann, W.Decking and N.Golubeva, TESLA-FEL 2007-05	D00000001073531
7	Laser Heater	TA 4 – Uppsala University, 9.07.2010	D00000002102441
8	Linac Temperature Stabilization	Presentation H.-J. Eckoldt: Temperature in XTL	D00000002060381
9	New Photon energy range	Presentation T. Tschentscher: Update on X-ray layout and parameters	D00000002164331
10	Technical description Charge Monitor System		
11	Technical description Beam Position Measurement System		
12	Technical description Beam Loss Monitor System	Conceptual Design Description for the BLM System for XFEL	D00000001969661
13	Technical description Dark Current Monitor System	CDR – WP 7 – Dark Current Monitor System, XFEL Conceptual Design Review	D00000001851211

Ref. #	Subject	Title of Note	EDMS ID or other reference
14	Technical description Screen Monitor System		
15	Technical description Transverse Deflecting rf Structure		
16	Harmonic Lasing	Harmonic lasing in X-ray FELs	D00000003099751
17	Self-Seeding Hard X-Rays	Extension of Self- Seeding to Hard X-Rays > 0 keV as a Way to Increase User Access at the European XFEL	DESY11-224
18	Self-Seeding Soft X-Rays	Self-Seeding Scheme for the Soft X-Ray Line in European XFEL	DESY 12-034
19	Timing System	XFEL Timing System Specification	D00000003185391
20	Simultaneous XFEL operation with different bunch charges	Injector Optimization for Simultaneous Operation with Different Bunch Charges	http://www.desy.de/xfel- beam/talksbyperson.html#akot_evgenij
21	XFEL Injector Dogleg	Large Energy Acceptance Dogleg for the XFEL Injector	IPAC2011: WEPC007