

**European X-Ray
Free-Electron Laser
Facility GmbH**

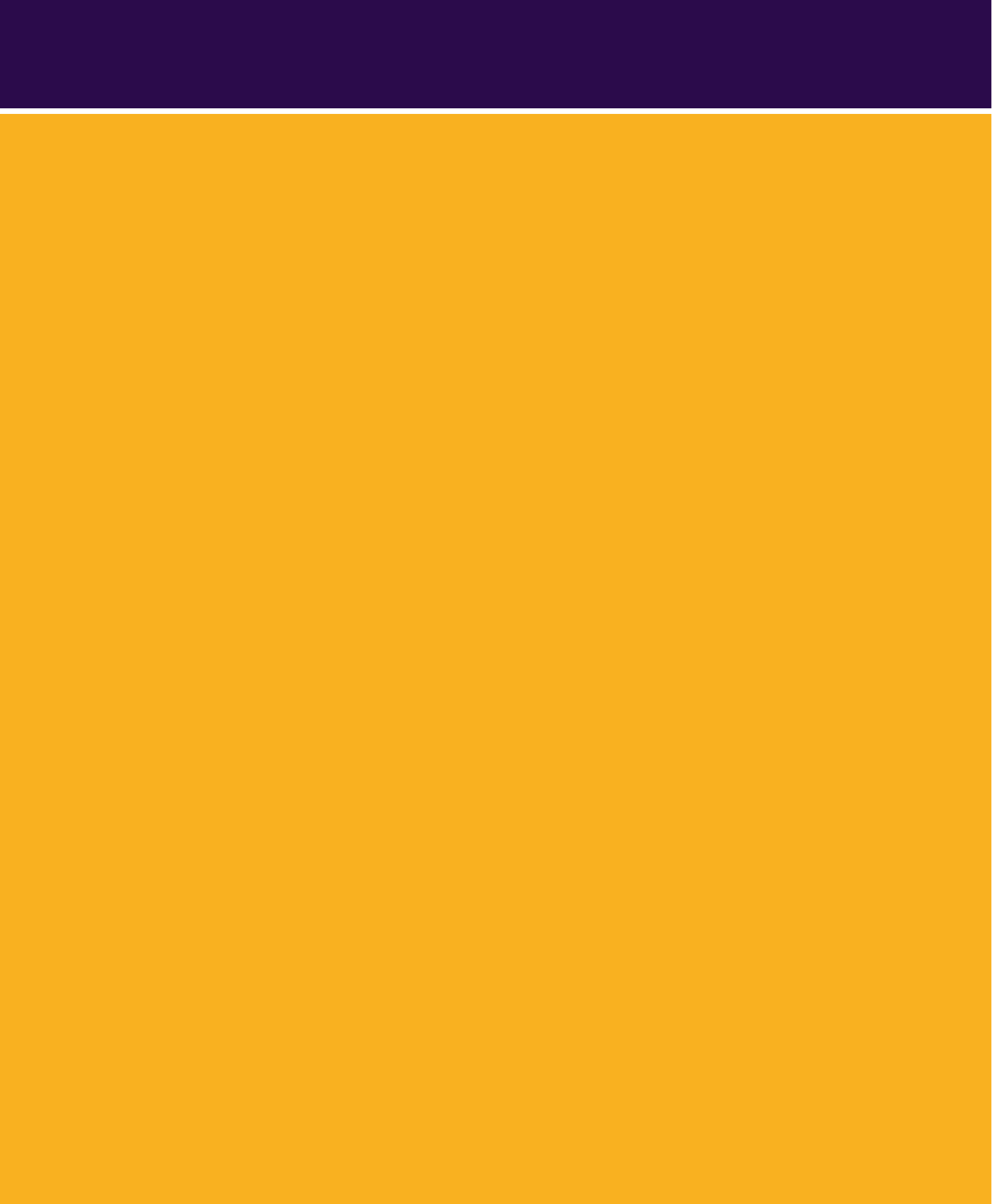



The European XFEL is organized as a non-profit company with limited liability under German law (GmbH) that has international shareholders.



2014

ANNUAL REPORT

**European X-Ray
Free-Electron Laser
Facility GmbH**

CONTENTS

6 FOREWORD

- 6 Foreword by the Management Board
- 10 Foreword by the Council Chairman

01

12 NEWS AND EVENTS

02

18 FACTS AND FIGURES

- 20 At a glance
- 22 Staff
- 28 Organization chart
- 29 Budget
- 31 Shareholders
- 32 Organs and committees
- 43 Cooperation
- 49 User consortia
- 50 Short history of European XFEL

03

60 CIVIL CONSTRUCTION

04

70 IN-KIND CONTRIBUTIONS

- 72 IKC Overview
- 82 Accelerator Consortium

05

94 PHOTON BEAM SYSTEMS

- 96 Undulator Systems
- 100 Simulation of Photon Fields
- 104 Theory
- 108 X-Ray Optics and Beam Transport
- 112 X-Ray Photon Diagnostics

06

118 SCIENTIFIC INSTRUMENTS AND EQUIPMENT

- | | | | |
|-----|-------------------------------|-----|---------------------------------|
| 120 | Scientific Instrument FXE | 146 | Optical Lasers |
| 123 | Scientific Instrument HED | 150 | Sample Environment |
| 128 | Scientific Instrument MID | 154 | Central Instruments Engineering |
| 133 | Scientific Instrument SCS | | |
| 138 | Scientific Instrument SPB/SFX | | |
| 142 | Scientific Instrument SQS | | |

07

156 DETECTORS AND DATA ACQUISITION

- 158 Detector Development
- 162 Advanced Electronics
- 164 Control and Analysis Software
- 167 IT and Data Management

08

170 SERVICES

- | | | | |
|-----|-------------------------------|-----|---------------------------------|
| 172 | Administrative Services | 187 | Technical Services |
| 176 | Internal Audit | 192 | Safety and Radiation Protection |
| 177 | Human Resources | | |
| 179 | Press and Public Relations | | |
| 182 | User Office | | |
| 183 | Photon Systems Project Office | | |

09

196 SCIENTIFIC RECORD

- 198 European XFEL Users' Meeting
- 199 Hard X-Ray FEL Collaboration Meeting
- 199 RACIRI Summer School
- 200 Workshops
- 201 Seminars
- 202 Publications

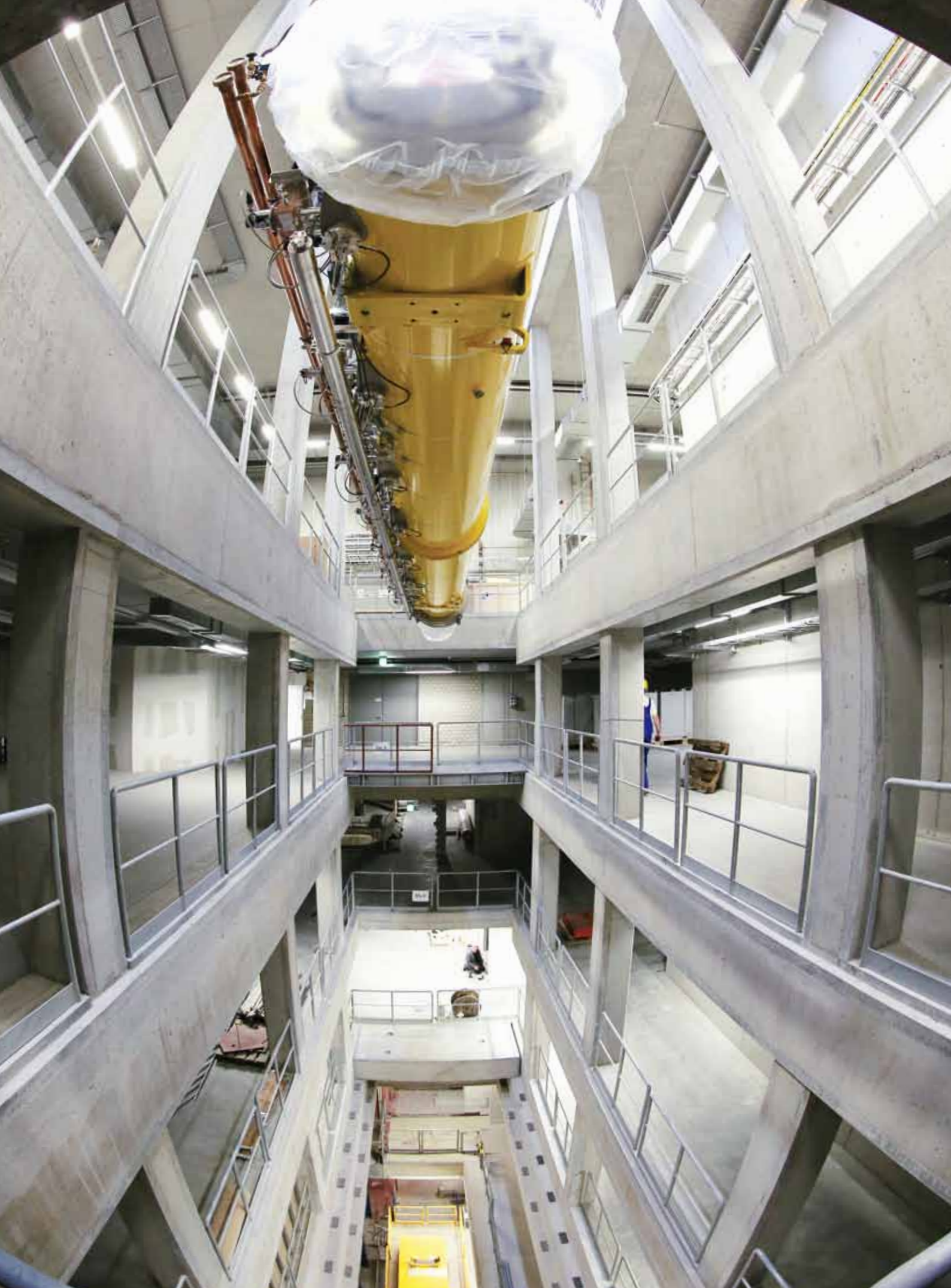

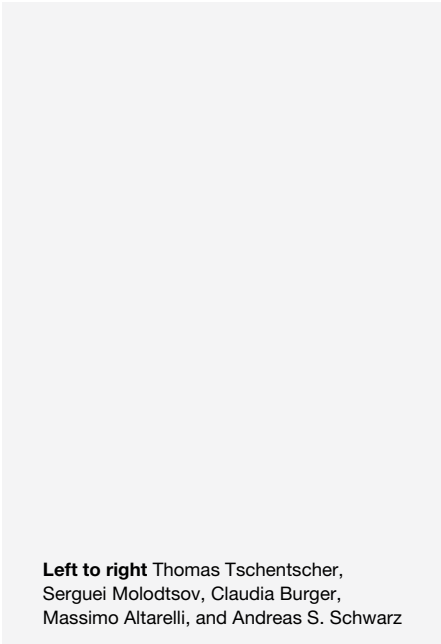

Dear Readers,

This annual report is intended to bring you up to date with the progress of the construction of the European XFEL facility during 2014. We would also like to share with you the excitement and enthusiasm of our staff and of the community of potential users worldwide.

An important achievement in 2014 was reaching the required assembly rate for the accelerator modules and the necessary production rate for the very important radio frequency (RF) couplers, which transport the power of the microwave field needed to accelerate the electrons to the cavities inside the modules. These achievements mitigated considerable schedule risks for the project and opened the way to strategies for accelerating the production and installation of the linear accelerator in the tunnel.

The installation of the injector laser and of the accelerating structures for the injector also progressed well. Commissioning with beam is expected to start in mid-2015. By the end of 2014, eight of the total 100 accelerator modules had been installed in their final configuration in the tunnel.

Infrastructure installation in the photon tunnels also made great progress and, in the last quarter of the year, the first components for the undulator systems that generate the X-ray flashes were lined up in the tunnel. The 91 undulator segments for all three undulators of the startup phase were in house by the end of the year. At the same time, a large fraction of the components for the intersections between two consecutive undulator segments were also delivered.

In 2014, the financial resources required to equip one of the hard X-ray undulators with the components needed for self-seeding became available. Self-seeding is a technique, invented by scientists from European XFEL and Deutsches Elektronen-Synchrotron (DESY), that greatly improves the quality and reproducibility of the pulses produced by X-ray free-electron lasers (FELs).

The X-ray laser pulses generated in the undulators will be guided to the experiment hall by photon beam transport systems, which include appropriate diagnostic equipment. Developments for various diagnostic components were performed in house or in collaboration with other partners, and tests at existing FEL facilities were very successful. The most challenging parts of the photon beamlines are the mirrors, with properties that exceed the previous state of the art and require extremely sophisticated technologies.

In 2014, the basic infrastructure for climate control, power distribution, and media in the experiment hall was completed and the first experiment enclosure, a very heavy concrete hut for the High Energy Density Science (HED) instrument, was built.

A major effort—undertaken with the help of specialized engineering companies and advisory committees—was made to optimize the experiment hutches, their technical systems, and the corresponding procurement strategies.

The instruments are expected to receive beam in late 2016 or early 2017. The Femtosecond X-Ray Experiments (FXE) group started testing important pieces of instrumentation, including an X-ray emission spectrometer. It will adopt the 2D Large Pixel Detector (LPD), developed by a consortium led by the Rutherford Appleton Laboratory in Oxfordshire, United Kingdom, on behalf of European XFEL. The Single Particles, Clusters, and Biomolecules and Serial Femtosecond Crystallography (SPB/SFX) instrument will adopt the Adaptive Gain Integrating Pixel Detector (AGIPD), also developed on behalf of European XFEL.

The other instruments are also making progress. The Optical Lasers, Detector Development, and Sample Environment groups are closely collaborating with the instrument groups to produce the surrounding equipment needed for a world-class experimental programme. In collaboration with the University of Hamburg, theoretical support for the experiments at the European XFEL was started.

The former Data Acquisition (DAQ) and Control Systems group was divided into three groups: Advanced Electronics, Control and Analysis Software, and IT and Data Management. This new structure is enabling European XFEL to perform the tasks of the former DAQ and Control Systems group more efficiently.

In May, construction started on the headquarters building, with laboratories and offices just above the experiment hall. Completion is expected in spring 2016.

At the end of 2014, very positive news came from the United Kingdom: the decision of the government to join European XFEL as a full member, with a contribution of up to 30 million pounds for the construction of the facility. This is yet another sign of the confidence of the international scientific community in the bright future of the European XFEL.

All the achievements of 2014 were the results of the efforts and competence of our staff and that of our partner institutions, to whom we wish to express our deep gratitude. We would also like to thank the Council and the members of our committees for their valuable advice as well as the governments of our partner countries for their ongoing support of the project. Together, we continue to build a leading new international research facility that will help take on some of society's grand scientific challenges.



Massimo Altarelli

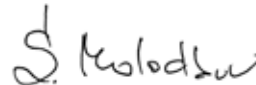

Serguei Molodtsov



Claudia Burger



Andreas S. Schwarz

Managing Directors



Thomas Tschentscher

Scientific Directors

Martin Meedom Nielsen



Dear Readers,

It was a great honour for me to be appointed chairman of the European XFEL Council in 2014, together with Lars Börjesson as the new vice chairman. Although new in this position, I have had the pleasure of following this exciting project from the beginning—first out of scientific curiosity and then as a delegate to the council since 2010. As a scientist, I have had the pleasure to perform several experiments at the two operational hard X-ray free-electron lasers (FELs)—the Linac Coherent Light Source (LCLS) in California and the SPring-8 Angstrom Compact Free Electron Laser (SACLA) in Japan—often in close collaboration with staff from European XFEL. If anything, this experience serves to underline the immense challenges and hard work involved in making an X-ray FEL facility capable of producing scientific results and, at the same time, enabling the truly marvellous range of new scientific discoveries still waiting to be made.

Judging from the overflowing auditorium at the 2014 European XFEL Users' Meeting, the user community shares the high expectations of the scientific possibilities and is eager to take advantage of the tremendous progress that is being made in X-ray science at FEL facilities. European XFEL is making every effort to build a world-class facility to meet these expectations and is actively incorporating developments based on the experience already gained as well as creating new solutions and ideas. There is no doubt in my mind that we are building in Europe what will become the best X-ray facility in the world.

Two very positive developments in 2014 underline the European dimension of the facility: In the spring, France became a full member of the European XFEL; then, just before the end of the year, the United Kingdom announced it would become the twelfth member state of the European XFEL, with an expected

contribution of about 30 million pounds to the construction costs. Earlier in 2014, the United Kingdom had already committed about 14 million euro to two user consortia at European XFEL.

Building the European XFEL is a technical challenge in many fields, and many of the components being assembled have been improved to an extent never even dreamt of a decade ago. Therefore, it seems almost unavoidable to encounter challenges that were not foreseen in the original planning. Indeed, by late 2013, it became clear that the original estimate for first light at the facility would have to be postponed by one year until the end of 2016, with a similar delay for user operation. In the meantime, the European XFEL Council, Management Board, staff, and project partners are making every effort to minimize the impact of the delay on the project.

The European XFEL Council met three times in 2014, taking note of the reports by the European XFEL Council Chairman, Management Board, Administrative and Finance Committee (AFC), Machine Advisory Committee (MAC), and Scientific Advisory Committee (SAC). The council discussed and decided on a number of important issues concerning staff, legal matters, in-kind contributions, and project management as well as financial and organizational matters. The one-year delay has occupied much of the council's discussions and will likely continue to do so for the next year as we strive to smooth the way for the project in response to a changing situation. I am confident that European XFEL has the staff, management, and council to overcome the challenges and, together with the member countries and project partners, to create the world's best facility for X-ray-based science.

Finally, I would like to thank the former chairman, Robert Feidenhans'l, and the former vice chairman, Pavol Sovák, for their tremendous efforts in advancing the project over many years. Fortunately, they both continue to serve as national delegates in the council, so we will continue to have the benefit of their deep knowledge of and commitment to the project.



Martin Meedom Nielsen

Chairman of the European XFEL Council

01

NEWS AND EVENTS

In 2014, European XFEL continued to attract interest from scientists around the world. The United Kingdom funded a user consortium and later announced it would join the facility as a full member. The facility itself made steady progress throughout the year.

Tour during Hard X-Ray FEL Collaboration Meeting





January 2014

31 January
Excitement builds among scientists at Users' Meeting

The joint 2014 European XFEL and DESY Photon Science Users' Meeting, held on 29–31 January, attracts experts and future users from around the world. During the first two days, almost 600 participants—breaking last year's attendance record of 500—hear talks by European XFEL project leaders and instrument scientists about progress made in 2013 and discuss the next steps toward the end of the construction phase and the beginning of user operation.

Further topics presented are the latest details on infrastructure plans for the Schenefeld experiment hall, the newest developments in instrument design, an update on the status of accelerator assembly, status presentations from the DESY FLASH and PETRA III facilities, and recent work at partner facilities and universities. As European XFEL Scientific Director Serguei Molodtsov emphasizes, the constantly increasing number of participants in the Users' Meeting shows that the exciting possibilities offered by the new facility are attracting ever more potential users.



February 2014

18 February
Building the perfect mirror

To ensure that 27 000 X-ray flashes per second reach their intended targets without distortions, scientists at European XFEL have developed a unique mirror that can maintain the X-ray laser qualities. A prototype is being measured and tested at Helmholtz-Zentrum Berlin, Germany.



The mirror is approximately 1 m long—the length needed to reflect the X-rays at the required extremely shallow angles—and the mirror's surface cannot deviate more than a few nanometres from perfect flatness. That is the equivalent of a road going uphill or downhill by no more than the width of a human hair for 28 km. To reflect X-rays, very high-quality mirrors are required. If the X-rays also have a laser-like quality, the mirrors need to be better than the best quality available today.

25 February
France becomes European XFEL's third-largest shareholder

France officially joins the European XFEL as a shareholder country, contributing 36 million euro (at 2005 price levels) toward the facility construction. These contributions, which comprise about 3% of the construction costs, make France the third-largest shareholder.

Two French research organizations—Commissariat à l'Énergie Atomique et aux Énergies Alternatives (CEA) and Centre National de la Recherche Scientifique (CNRS)—represent the country at the signing in Hamburg. CNRS, the largest fundamental research organization in Europe, contributes to the European XFEL through the production, radiofrequency conditioning, and delivery of accelerator power couplers. CEA is a public research body and contributes to the European XFEL by assembling 100 accelerator modules and by providing the beam position monitors for the accelerator cavities. With the addition of France, a total of nine countries have formalized their commitment to the European XFEL project by becoming shareholders.



April 2014

16 April

Paving the way to accessing handedness

An international team of researchers—led by scientists at European XFEL—publishes the description of a method to accurately measure the degree of circular polarization of each individual X-ray pulse, in the journal *Nature Communications*. Circularly polarized X-rays can reveal new information about chemical asymmetries, which can help in the design of new chemical and pharmaceutical processes, or bring forward innovations in computer data storage.

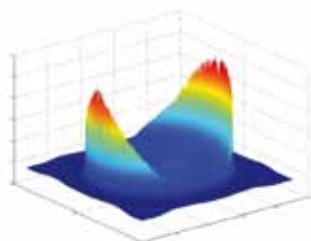

30 April

Russian Ambassador visits European XFEL and DESY

The ambassador of the Russian Federation, Vladimir M. Grinin, visits DESY and European XFEL. On a tour to the DESY synchrotron radiation source PETRA III and the European XFEL construction site, he is able to get a picture of the diverse collaborations of researchers based in Germany with Russian institutes.

May 2014

8 May

Observing electron clouds, scientists could improve chemical processes

An international team of researchers—including scientists from European XFEL, DESY, and the Max Planck Institute for Biophysical Chemistry—report in the journal *Nature* that, using an X-ray laser, they have looked more precisely than ever before into the electron cloud that surrounds a molecule and keeps it together.

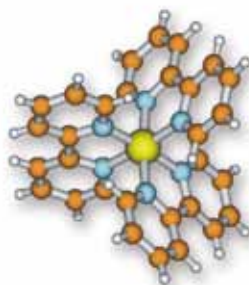

The team manages to document changes in the states of electrons in a way similar to how pictures taken at different times can be assembled into a movie. They are also able to get information comparable to razor-sharp images of even very short-lived transition states that other methods miss. Intermediate states exist on time scales ranging from several femtoseconds (quadrillionths of a second) to ten thousand times longer, and each is decisive for the subsequent course—and final outcome—of chemical reactions. The researchers' work is considered to be an important step toward atomic- and electronic-scale movies of chemical reactions.

June 2014

5 June

University of Rostock and European XFEL continue cooperation

The University of Rostock and European XFEL will continue their collaboration within the framework of a new cooperation agreement. This is announced in Rostock by the University Vice-Rector of Research and Research Education, Birgit Piechulla, and the European XFEL Managing Directors, Massimo Altarelli and Claudia Burger. The objective is a close cooperation in research and education, particularly in the field of applications for free-electron lasers.



June 2014

5 June
UK invests in European XFEL user consortium

The Biotechnology and Biological Sciences Research Council (BBSRC), the Medical Research Council (MRC), and the Wellcome Trust, all based in the United Kingdom, announce their intention to contribute 5.64 million pounds (M£) towards a user consortium at the European XFEL. Between 2014 and 2019, the funding will help to construct and operate the Serial Femtosecond Crystallography (SFX) part of the Single Particles, Clusters, and Biomolecules and Serial Femtosecond Crystallography (SPB/SFX) scientific instrument at the European XFEL, which is dedicated to high-throughput nanocrystallography and sample screening.

SFX will form an integral part of the SPB/SFX instrument and will use the X-ray free-electron laser beam transmitted through the SPB/SFX instrument's first interaction region, allowing simultaneous measurements at two separate experiment stations. The proposal is led by DESY and includes, besides the UK, contributions from Germany, Sweden, Slovakia, Australia, and the US.

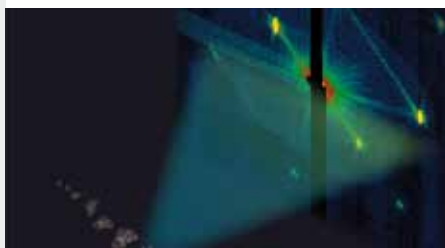

26 June
European XFEL Council appoints a new Chairman and Vice Chairman

The European XFEL Council elects Martin Meedom Nielsen from the Technical University of Denmark in Kongens Lyngby as its Chairman and Lars Börjesson from Chalmers University of Technology in Gothenburg, Sweden, as its Vice Chairman. Managing Directors Massimo Altarelli and Claudia Burger thank the outgoing Chairman Robert Feidenhans'l and Vice Chairman Pavol Sovák for their dedicated work and commitment in the past years. The European XFEL Council is the supreme organ of the company, functioning as the shareholder assembly and deciding on important issues of company policy.



Martin Meedom Nielsen and Lars Börjesson

October 2014

10 October
Collaboration in theoretical physics with the University of Hamburg

European XFEL announces that it will collaborate with the group of Alexander I. Lichtenstein from the Institute of Theoretical Physics at the University of Hamburg. The goal is to generate ideas for novel applications or for new methods to extract information from the data acquired at the European XFEL.



Alexander I. Lichtenstein

The support of a dedicated theoretical effort can considerably enhance the chances of success in research, as many other major labs have shown. European XFEL has developed and maintained a small but very successful theory and simulation effort in the area of free-electron laser beam generation and propagation that has achieved international recognition. The collaboration with the University of Hamburg complements this activity with more specific theoretical support for experiments. European XFEL already appointed two scientists in the areas of electronic structure theory and molecular dynamics.

November 2014

19 November

Thick concrete walls against the power of a trillion light bulbs

The first enclosure for a scientific instrument is erected in the experiment hall. It is a 900 t concrete construction, providing a space of about 100 m² within walls of iron-enriched concrete of up to 1 m thickness. The enclosure will house the High Energy Density Science (HED) instrument, which is designed to investigate matter under extreme conditions of pressure, temperature, or electric fields—some of which are similar to those found in planets inside or outside of our solar system.



These conditions will be generated by an extremely strong optical laser able to create hotspots with a peak power of 100 terawatts. When tightly focused, extremely high intensities will be reached that can accelerate electrons from the probes to relativistic energies. Scattered electrons then emit high-energy gamma or X-ray radiation requiring extra shielding. The ultrahigh-intensity optical laser is a planned contribution from the Helmholtz International Beamline for Extreme Fields at the European XFEL (HIBEF) user consortium.

December 2014

17 December

UK announces intention to join European XFEL

The United Kingdom announces its intention to become the twelfth member state of European XFEL and to invest up to 30 M€. “We will now work to negotiate formal UK membership of this exciting new facility, building on our own national capabilities and facilities and allow the UK to develop entirely new scientific opportunities”, John Womersley of the Science and Technology Facilities Council (STFC), which will manage the UK membership in the European XFEL, is quoted as saying. “Today’s announcement shows our determination to ensure UK science remains at the very forefront of global research”, the UK Minister for Universities and Science, Greg Clark, is quoted in the same news release.

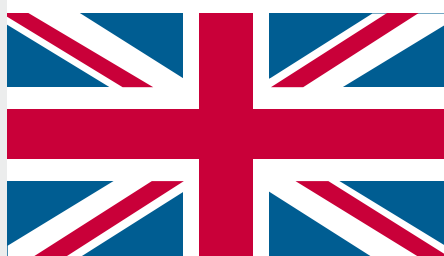

22 December

Ultrafast X-ray detector successfully tested

Scientists from European XFEL have successfully tested the first ultrafast X-ray detector to be used for experiments at the new research facility. The new Large Pixel Detector (LPD) is intended for use as of 2017 on the Femtosecond X-Ray Experiments (FXE) instrument to observe ultrafast reactions, including the formation and breaking of molecular bonds. After six years of development at Rutherford Appleton Laboratory in the UK, the successful test is important progress toward recording molecular movies, which will enable scientists to better understand the elementary steps of chemical processes and to contribute to the development of more efficient industrial production methods. The detector must be able to capture one picture every 222 ns (a nanosecond is a billionth of a second) and be able to yield precise results even when very large differences in intensity—very high and very low intensity regions—coexist in the same picture.



02

FACTS AND FIGURES

European XFEL continues to foster new connections with scientific institutes from around the world while also expanding its workforce, which in 2014 grew to over 200 people from 31 different countries.

Reviewing details of the facility







Figure 1 Aerial view of the European XFEL facility. **Left to right** Schenefeld, Osdorfer Born, and DESY-Bahrenfeld sites.

AT A GLANCE

The European XFEL is a research facility that will open up new research opportunities for science and industry. Currently under construction in Hamburg and Schleswig-Holstein in northern Germany, the 3.4 km long X-ray free-electron laser (FEL) will generate ultrashort X-ray flashes for photon science experiments with a peak brilliance that is a billion times higher than that of the best synchrotron X-ray radiation sources.

Brilliant light for new research opportunities

With a repetition rate of 27 000 pulses per second and an outstanding peak brilliance, the European XFEL facility will produce ultrashort X-ray flashes that will allow researchers to map the atomic details of viruses, decipher the molecular composition of cells, take three-dimensional images of the nanoworld, film chemical reactions, and study processes like those occurring deep inside planets.

The European XFEL will be located mainly in tunnels 6 to 38 m underground with inner diameters of up to 5.3 m, roughly the diameter of a subway tunnel. The 3.4 km long facility will run from the Deutsches Elektronen-Synchrotron (DESY) research centre in Hamburg to the town of Schenefeld in the German federal state of Schleswig-Holstein (Figure 1). The new facility will comprise three sites: the DESY-Bahrenfeld site with the injector complex, the Osdorfer Born site with one distribution shaft, and the Schenefeld campus site, which will host the underground experiment hall with a large laboratory and office building on top. The latter will serve as the company headquarters.

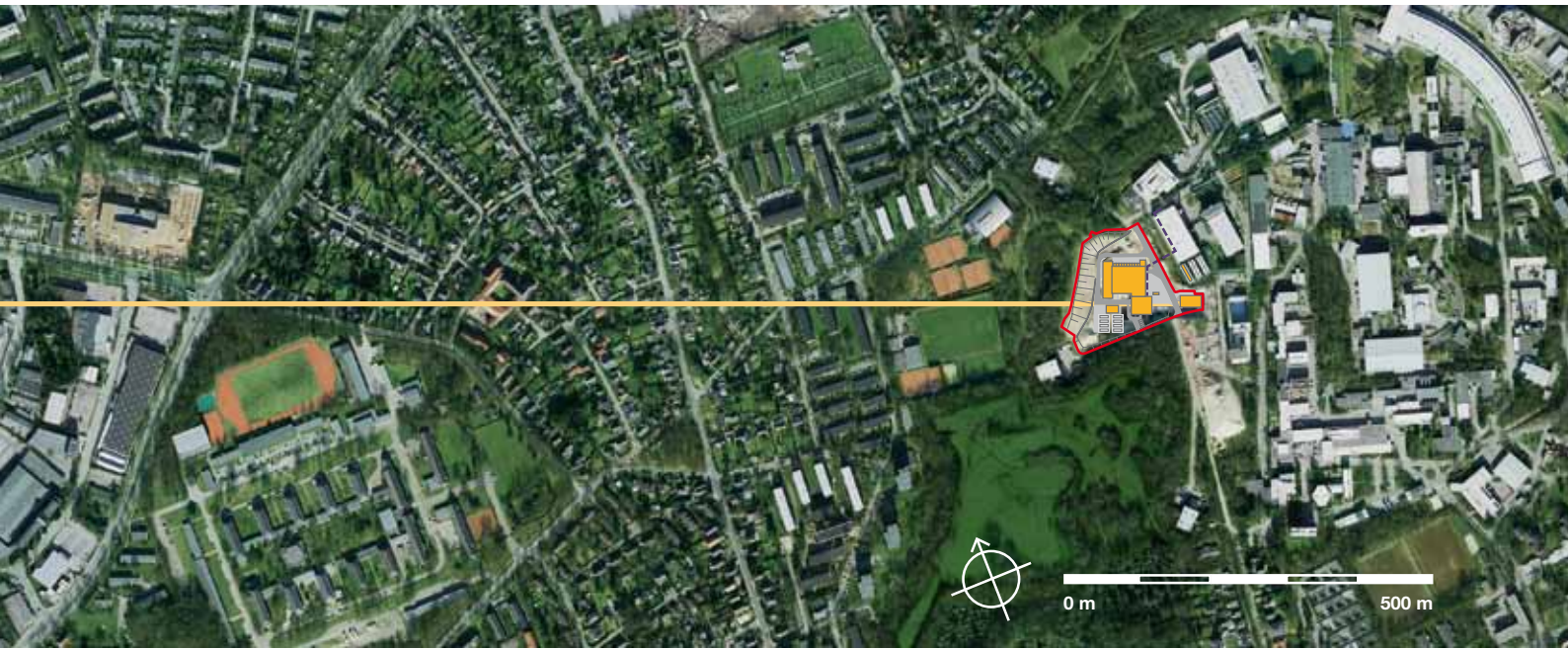

European XFEL GmbH

As of December 2014, 11 countries are participating in the European XFEL project: Denmark, France, Germany, Hungary, Italy, Poland, Russia, Slovakia, Spain, Sweden, and Switzerland. In December 2014, the United Kingdom stated its intention to join the European XFEL as the twelfth member state. The international partners have entrusted the construction and operation of the facility to the non-profit European X-Ray Free-Electron Laser Facility GmbH, which was established in October 2009 as a limited liability company under German law. The facility is a joint effort of many partners. The company cooperates closely with its largest shareholder, DESY, a research centre of the Helmholtz Association, and with other organizations worldwide. When user operation starts in 2017, European XFEL will employ about 280 people.

Construction costs

Construction of the European XFEL facility started in early 2009. The beginning of commissioning is planned for 2016. User operation with three beamlines and six instruments will start in 2017.

The construction costs, including commissioning, amount to 1.15 billion euro (at 2005 price levels). Currently, the host country, Germany (federal government, city-state of Hamburg, and state of Schleswig-Holstein), covers 58% of the costs. Russia contributes 27%, and each of the other international shareholders between 1% and 3%. To a great extent, the European XFEL facility will be realized by means of in-kind contributions by shareholders and partners. ■

STAFF

In 2014, the European XFEL workforce of employees, students, and guests grew from 202 to 233 (+15%).

The number of employees increased as follows:

- Scientists: 104 (+15)
- Engineers: 66 (+10)
- Technicians: 22 (+4)
- Administrative staff: 41 (+2)

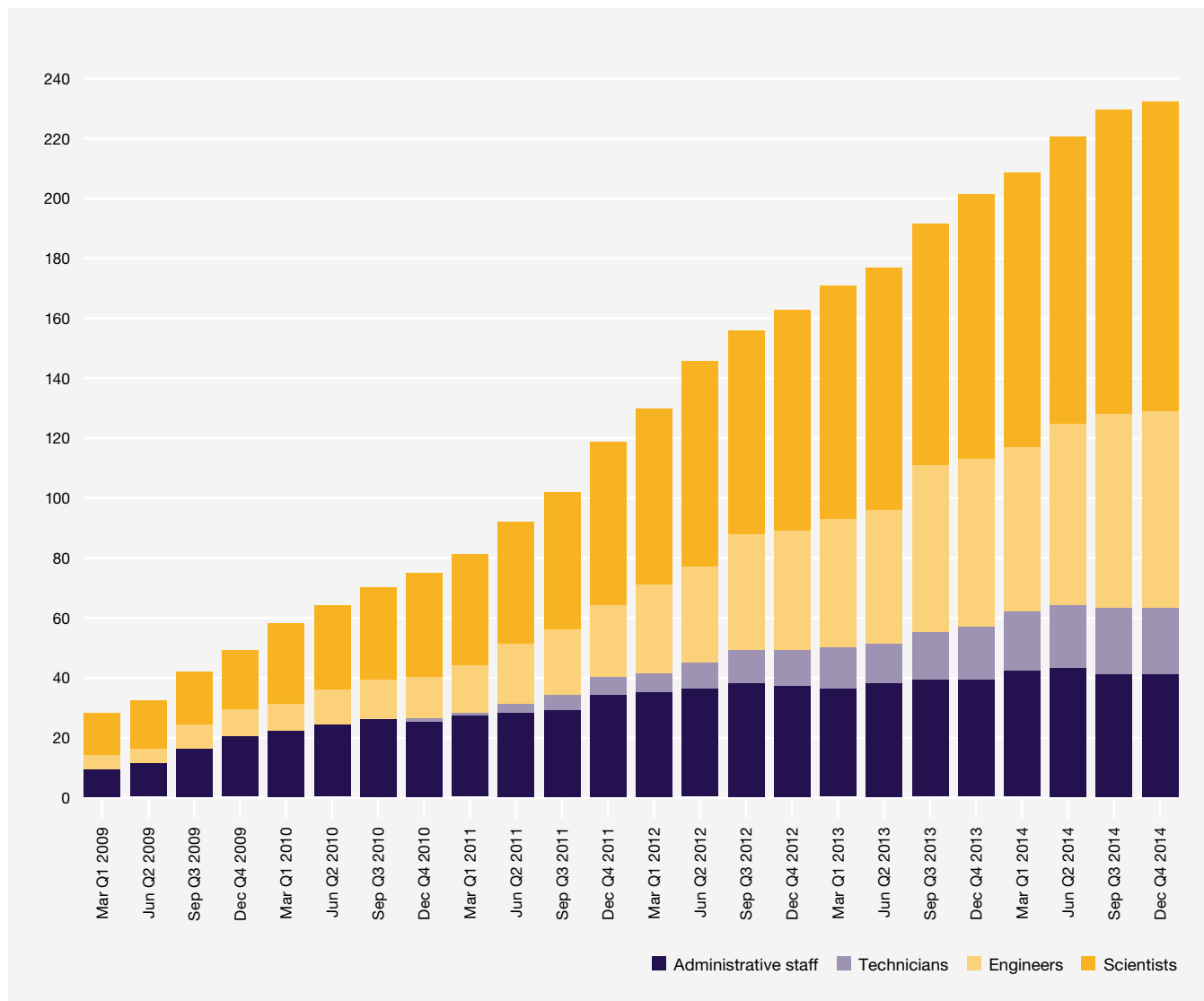
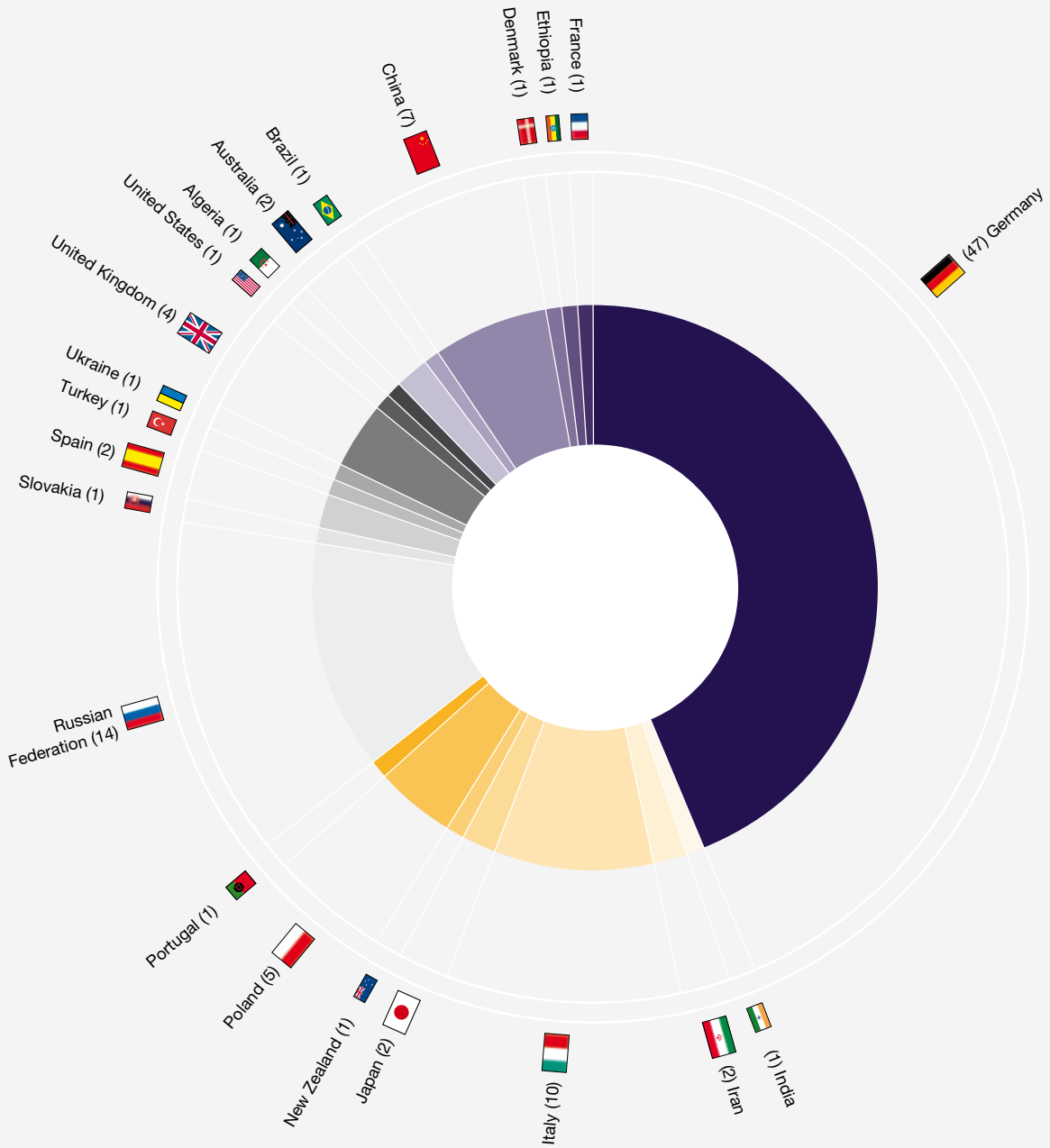

Figure 1 Quarterly growth in the number of employees, students, and guests (2009–2014)



Germany: 44%
 Other countries: 56%
 22 nationalities

Figure 2 Nationalities of scientific staff (2014)

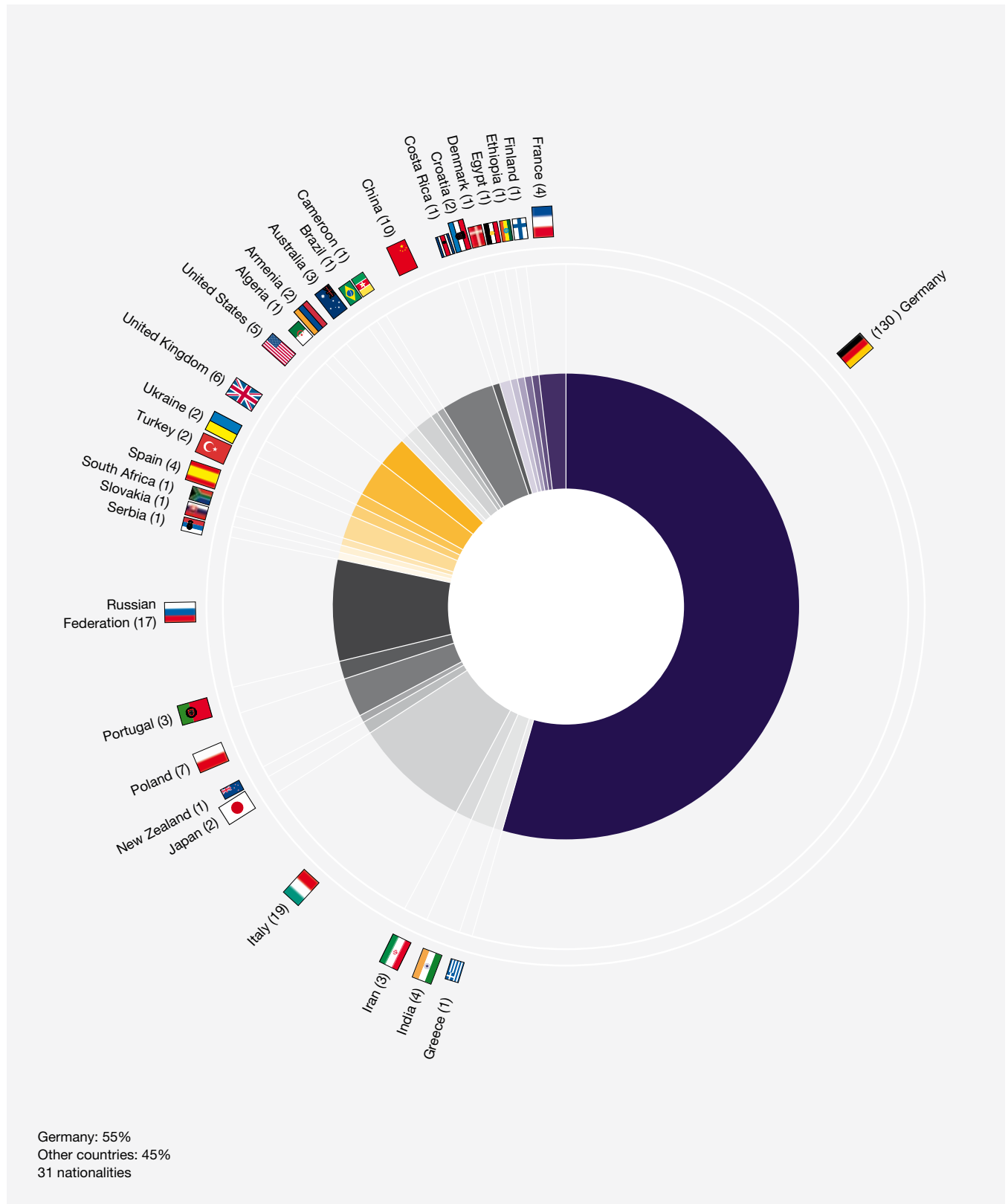

Figure 3 Nationalities of all (scientific and non-scientific) staff (2014)

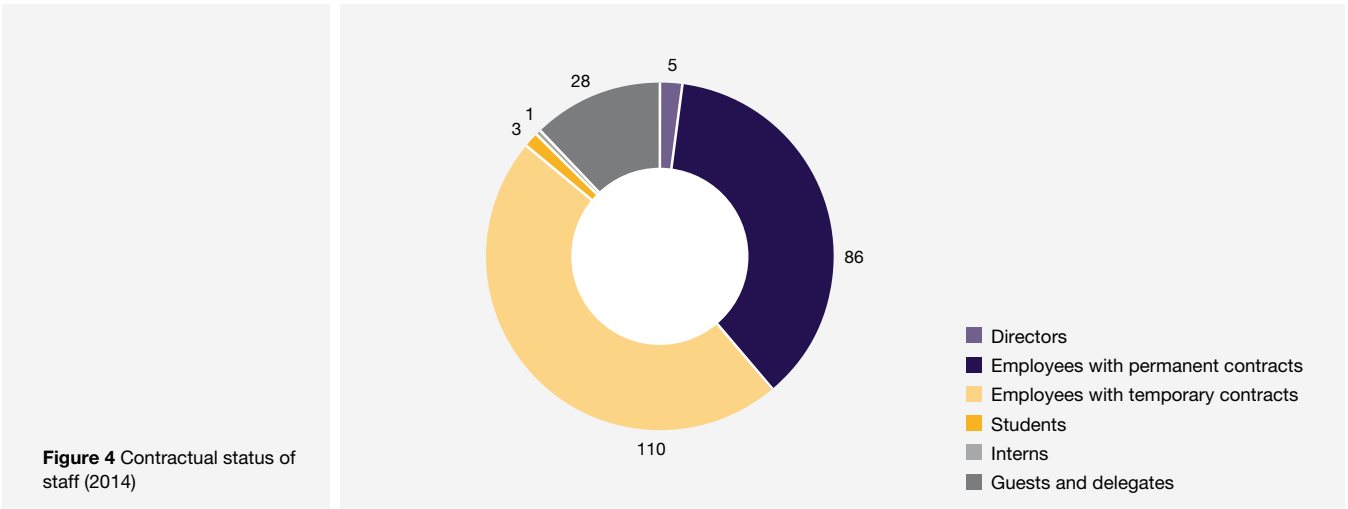

Figure 4 Contractual status of staff (2014)

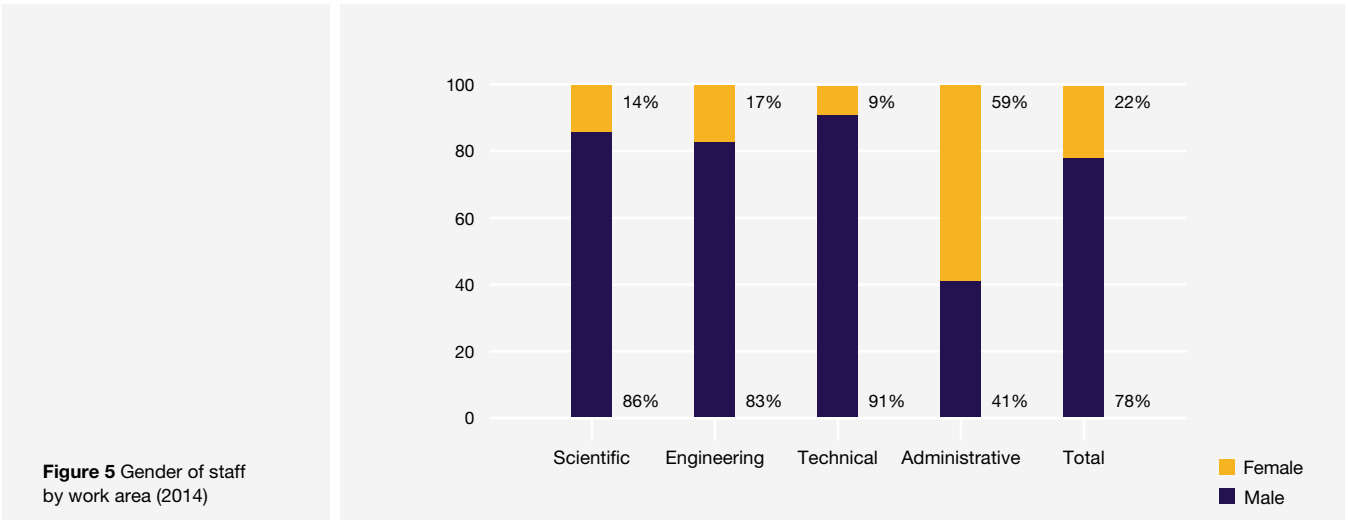

Figure 5 Gender of staff by work area (2014)

The share of staff from outside Germany among all European XFEL employees remained unaltered in the past year, while the share of the scientific staff from outside of Germany increased slightly:

- Total staff: 55% (± 0 from 2013) from Germany, 45% from other countries
- Scientific staff: 44% (- 1% from 2013) from Germany, 56% from other countries

A total of 31 (+ 2 from 2013) nationalities are now represented within the company. At the end of 2014, 22% of all employees and 14% of scientists employed at European XFEL were female.

The average employee age remained unchanged from the previous year, at 39 years. ■

**Staff of European XFEL
as of 31 December 2014**

Abeghyan, Suren	Dickert, Bianca	Karabekyan, Suren
Agapov, Ilya	Dietrich, Florian	Kaukher, Alexander
Akopov, Zaven	Dommach, Martin	Kellert, Martin
Altarelli, Massimo	Donato, Mattia	Kelsey, Oliver
Ament, Kurt	Dong, Xiaohao	Kersting, Lorenz
Ansaldi, Gabriele	Ebeling, Bernd	Kirsch, Jan Oliver
Appel, Karen	Eder,	Kist, Birthe
Arnold, Mathias	Catherine Ann Wamuyu	Kitel, Matthäus
Arslan, Süleyman	Eidam, Janni	Knaack, Manfred
Babies, Frank	Ekmedzic, Marko	Kniehl, Sandra
Bagha-Shanjani, Majid	Elizondo, Jorge	Knoll, Martin
Ballak, Kai-Erik	Emons, Moritz	Koch, Andreas
Bari, Sadia	Englisch, Uwe	Köhler, Martin
Bartmann, Alexander	Esenov, Sergey	Kohlstrunk, Nicole
Bartsch, Tobias	Ferreira Maia, Luís Goncalo	Korsch, Timo
Baskaran, Balakumaar	Flammer, Meike	Kozielski, Sigrid
Batchelor, Lewis	Frankenberger, Paul	Kristic, Hrvoje
Bean, Richard	Freijo Martín, Idoia	Kruse, Kai
Beckmann, Andreas	Freund, Wolfgang	Kujala, Naresh
Bendschneider, Martin	Fritz, Mareike	Kumar, Mayank
Berndgen, Karl-Heinz	Fritz-Nielen, Kitty	Kunz, Marc
Bertini, Silvia	Galler, Andreas	Kurta, Ruslan
Boehme, Elizabeth	Gawelda, Wojciech	Kuster, Markus
Bonucci, Antonio	Geloni, Gianluca	La Civita, Daniele
Borchers, Gannon	Gembalies, Imke	Lalechos, Antonios-Vassilios
Boukhelef, Djelloul	Gerasimova, Natalia	Lang, Philipp-Michael
Boyd, Eric	Geßler, Patrick	Lange, Torsten
Bressler, Christian	Giambartolomei, Gabriele	Laub, Malte
Britz, Alexander	Giewekemeyer, Klaus	Le Pimpec, Frédéric
Buck, Jens	Glaser, Leif	Lederer, Maximilian Josef
Burger, Claudia	Gorelov, Evgeny	Li, Yuhui
Carley, Robert	Grünert, Jan	Liu, Jia
Conta, Uschi	Guhlmann, Florian	Lorenzen, Kristina
Coppola, Nicola	Haas, Tobias	Lyamayev, Viktor
Cunis, Sabine	Hagitte, Magdalena	Madsen, Anders
Da Costa Pereira,	Hagitte, Martin C.	Malso, Michael
Maria Helena	Hallmann, Jörg	Mancuso, Adrian
De Fanis, Alberto	Hauf, Steffen	Manetti, Maurizio
Deiter, Carsten	Heeßel, Gabriela	Mazza, Tommaso
Delitz, Jan Torben	Heisen, Burkhard	Meger-Farshad, Danuta
Delmas, Elisa	Ilchen, Markus	Mergen, Julia
Deron, Georg Christian	Izquierdo, Manuel	Meyer, Michael
Di Felice, Massimiliano	Januschek, Friederike	Molodtsov, Serguei

**Guests of European XFEL
on 31 December 2014**

Moore, James
 Mulá Mathews, Gabriella
 Münnich, Astrid
 Nakatsutsumi, Motoaki
 Neumann, Maik
 Nidhi, Sneha
 Ogródowski, Yana
 Osterland, Christiane
 Palmer, Guido
 Parenti, Andrea
 Pereira Bahia, Liliane
 Pergament, Mikhail
 Pflüger, Joachim
 Piergrossi, Joseph W.
 Piórecki, Konrad
 Planas Carbonell, Marc
 Poljancewicz, Bartosz
 Poppe, Frank
 Priebe, Gerd
 Prollius, Michael
 Raab, Natascha
 Reifschläger, Jörn
 Reimers, Nadja
 Rodrigues Fernandes,
 Bruno Jesus
 Roth, Thomas
 Rüscher, Jan Christoph
 Rüter, Tonn
 Rychev, Mikhail
 Saaristo, Niko
 Salem, Osama Ahmed
 Samoylova, Liubov
 Sauermann, Wolf-Ulrich
 Schaper, Jörg
 Scherz, Andreas
 Scherz, Sabrina
 Schlee, Stephan A.
 Schmidt, Andreas
 Schmitt, Rüdiger
 Schrage, Marco
 Schulz, Carola
 Schulz, Joachim
 Schwarz, Andreas S.

Shie, Halimah
 Silenzi, Alessandro
 Sinn, Harald
 Sotoudi Namin, Hamed
 Sprenger, Uta
 Sztuk-Dambietz, Jolanta
 Szuba, Janusz
 Teichmann, Martin
 Thorpe, Ian
 Tolkiehn, Jan
 Trapp, Antje
 Tschentscher, Thomas
 Tscheu, Wolfgang
 Turcato, Monica
 van Hees, Brunhilde
 Vannoni, Maurizio
 Viehweger, Marc Simon
 Villanueva Guerrero, Raúl
 Wang, Jinxiong
 Weger, Kerstin
 Wegner, Ulrike
 Weidenspointner, Georg
 Wellenreuther, Gerd
 Winterhoff, Gundel
 Wißmann, Laurens
 Wolff-Fabris, Frederik
 Wrona, Krzysztof
 Yakopov, Mikhail
 Yang, Fan
 Yoon, Chunhong
 Youdjeu Tangwe,
 Melchiade Auguste
 Youngman, Christopher
 Zhang, Haiou
 Ziólkowski, Dawid

Assefa, Tadesse Abebaw
 Chao, Li
 Gong, Lingling
 Keil, Thorsten
 Ketinoglu, Bora
 Khakhulin, Dmitry
 Lu, Wei
 Mehrjoo, Masoud
 Messerschmidt, Marc
 Nawrath, Günther
 Nosik, Valery
 Pelka, Alexander
 Prat, Serge
 Raabe, Steffen
 Rafipoor, Amir Jones
 Sato, Tokushi
 Smolyakov, Nikolay
 Spencer,
 Jesse Huon Robinson
 Stäps, Christoph
 Stern, Stephan
 Sun, Yajun
 Utrecht, Charlotte
 Vagovič, Patrik
 von Appen, Jan
 Yaroslavtsev, Alexander
 Zhura, Alexander

02 FACTS AND FIGURES

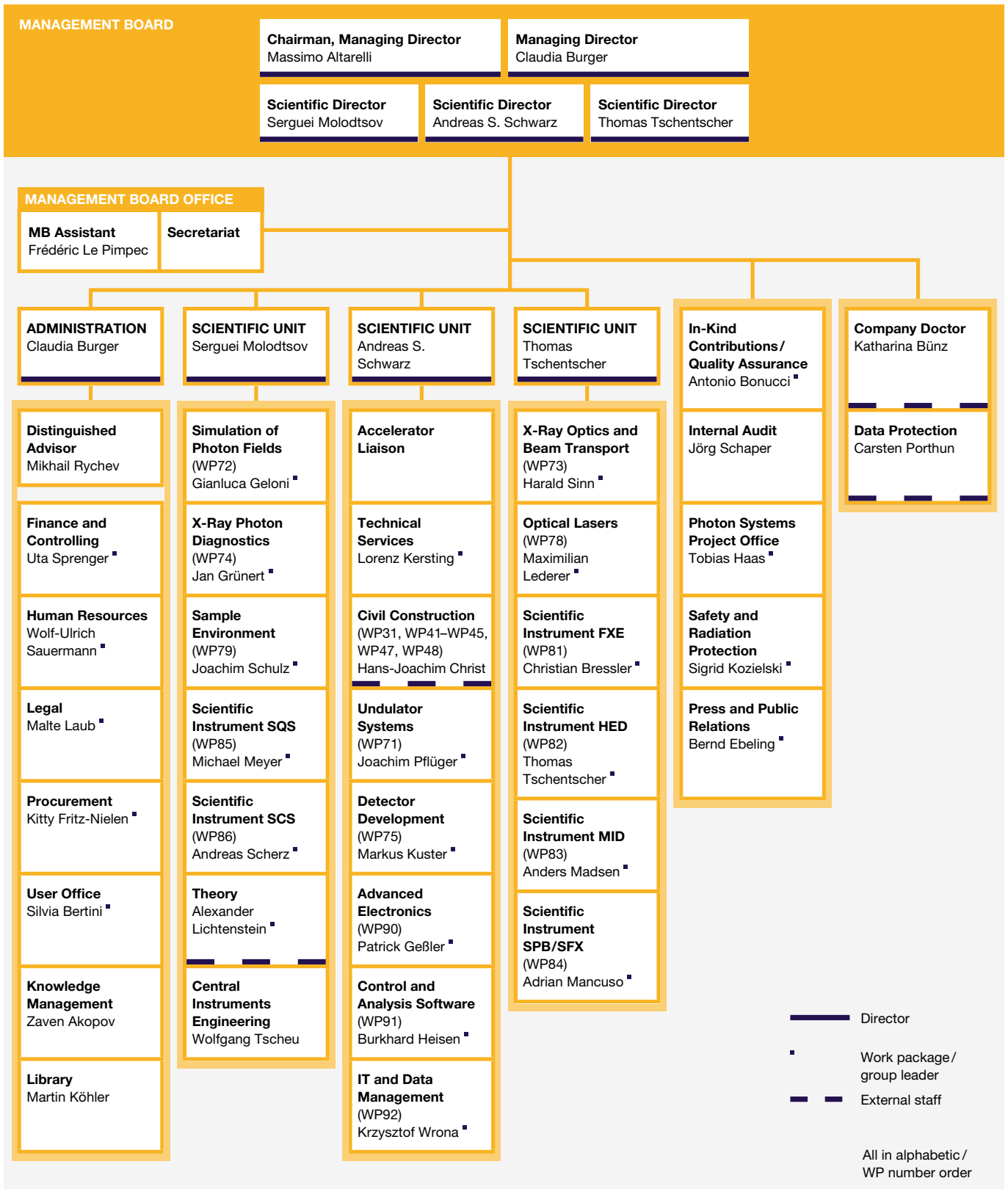

European X-Ray Free-Electron Laser Facility GmbH (December 2014)

BUDGET

The overall budget for the construction phase of the European XFEL is around 1.15 billion euro (2005 value). Almost half of the project volume is contributed in kind by the various partners (see Chapter 4, “In-kind contributions”). The remaining fraction of more than 0.7 billion euro (current value) is contributed in cash to the company by its shareholders and associated partners. At the end of 2014, as the construction of the European XFEL progresses, more than 60% of the total cash budget has been spent.

The company’s shareholder assembly, called the European XFEL Council, decides on the annual budget covering the project expenses during the corresponding year. The total European XFEL payment budget in 2014 amounted to 120 million euro (M€).

Major activities

The major activity in 2014 was “Machine and technical infrastructure”, with a budget of 67.4 M€ (56%). More than half of this budget, 37.3 M€, was devoted to civil construction, corresponding to the continuing above-ground activities, including the construction of the headquarters building in Schenefeld. For the major activity “Beamlines and experiments”, the payment budget was 47.5 M€ (39%). Of this, the largest fraction, 37.2 M€, was spent on capital investment.

In 2014, the main activity was machine and technical infrastructure, representing 56% of the year’s total budget.

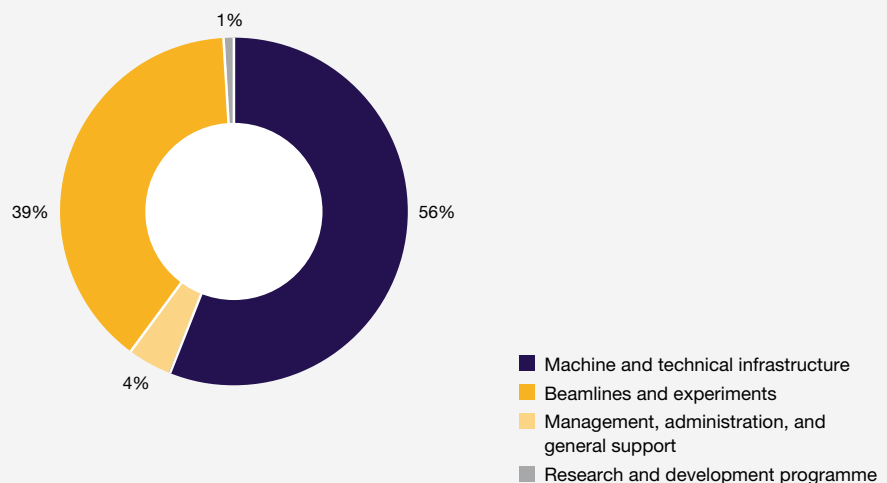

Figure 1 Payments by major activity in 2014

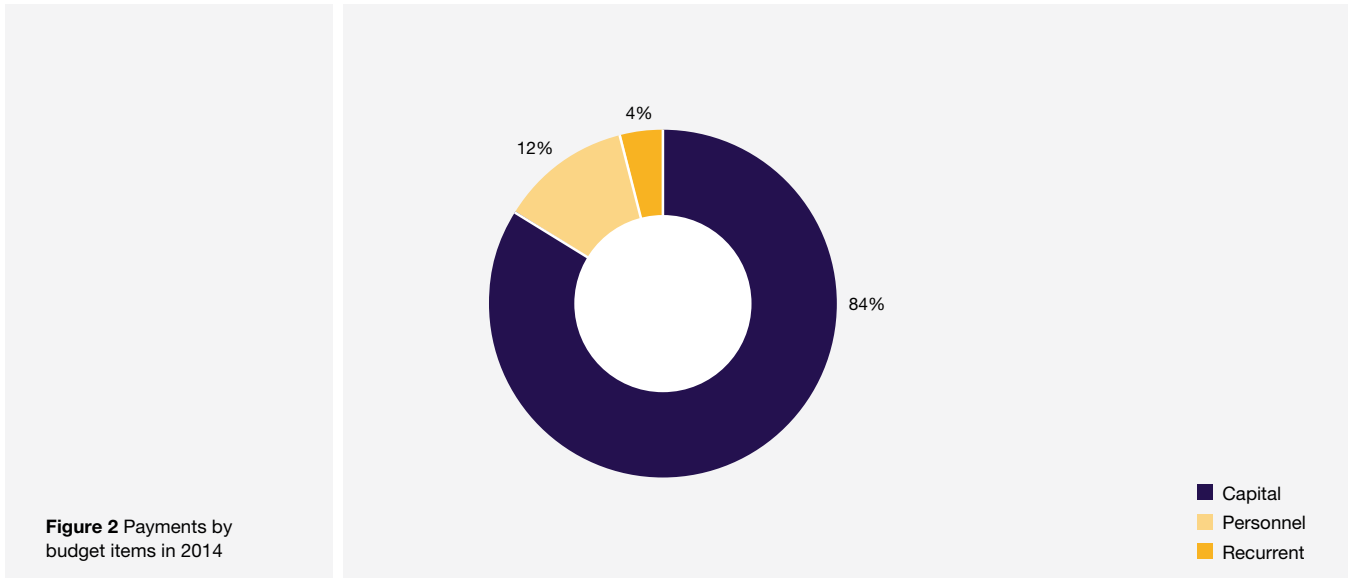

Figure 2 Payments by budget items in 2014

Budget items

The overwhelming portion (84%) of the 2014 payment budget was related to capital investment (Figure 2). This trend continues during the construction phase of the facility, as the biggest share of the project expenses are related to capital investment, with personnel and recurrent cost being of only subordinate importance.

Outlook for 2015

For the budget year 2015, a similar annual payment budget of 117.8 M€ was approved. ■

SHAREHOLDERS

The European XFEL, organized as a non-profit company with limited liability (GmbH) under German law, has international shareholders. The shareholders are designated by the governments of the international partners who commit themselves in an intergovernmental convention to support the construction and operation of the European XFEL.

Shareholders of the European XFEL GmbH (December 2014)

 Denmark	DASTI (Danish Agency for Science, Technology and Innovation)
 France	CEA (Commissariat à l'Énergie Atomique et aux Énergies Alternatives) CNRS (Centre National de la Recherche Scientifique)
 Germany	DESY (Deutsches Elektronen-Synchrotron)
 Hungary	NIH (Nemzeti Innovációs Hivatal)
 Poland	NCBJ (National Centre for Nuclear Research)
 Russia	Open Joint Stock Company RUSNANO
 Slovakia	Slovak Republic
 Sweden	Vetenskapsrådet (Swedish Research Council)
 Switzerland	Swiss Confederation

Likely future shareholders of the European XFEL GmbH

 Italy	Republic of Italy
 Spain	Kingdom of Spain

ORGANS AND COMMITTEES

The European XFEL Council is the supreme organ of the company. It functions as the shareholder assembly and decides on important issues of company policy.

European XFEL Council	
Chairman	Robert K. Feidenhans'l (University of Copenhagen, Denmark) until 30 June 2014 Martin Meedom Nielsen (DTU, Kongens Lyngby, Denmark) since 1 July 2014
Vice Chairman	Pavol Sovák (P.J. Šafárik University, Košice, Slovak Republic) until 30 June 2014 Lars Börjesson (Chalmers University of Technology, Gothenburg, Sweden) since 1 July 2014
Delegates	
Denmark	Robert K. Feidenhans'l (University of Copenhagen) since 1 July 2014, Martin Meedom Nielsen (DTU, Kongens Lyngby) until 30 June 2014, and Anders Kjær (DASTI, Copenhagen)
France	Maria Faury (CEA, Paris) and Alex C. Mueller (CNRS, Paris), both since 21 February 2014
Germany	Helmut Dosch (DESY, Hamburg) and Beatrix Vierkorn-Rudolph (BMBF, Bonn)
Hungary	Dénes Lajos Nagy (Wigner Research Centre for Physics, Hungarian Academy of Sciences, Budapest)
Poland	Grzegorz Wrochna (NCBJ, Otwock-Świerk)
Russia	Mikhail Kovalchuk (NRC "Kurchatov Institute", Moscow) and Andrey Svinarenko (OJSC RUSNANO, Moscow)
Slovakia	Karel Saksl (Institute of Materials Research, SAS, Košice) and Pavol Sovák (P.J. Šafárik University, Košice) since 1 July 2014
Sweden	Johan Holmberg (Swedish Research Council, Stockholm) and Lars Börjesson (Chalmers University of Technology, Gothenburg) until 30 June 2014
Switzerland	Bruno Moor (State Secretariat for Education, Research, and Innovation, Bern)

European XFEL Council (continued)	
Secretary	
	Malte Laub (European XFEL, Hamburg, Germany)
Vice Secretary	
	Meike Flammer (European XFEL, Hamburg, Germany)

The European XFEL Management Board is composed of two managing directors (*Geschäftsführer*, in the sense of German law on companies with limited liability) and three scientific directors.

European XFEL GmbH Management Board	
Managing Director and Chairman	Massimo Altarelli
Managing and Administrative Director	Claudia Burger
Scientific Director	Serguei Molodtsov
Scientific Director	Andreas S. Schwarz
Scientific Director	Thomas Tschentscher

Advisory committees support European XFEL in various matters: Administrative and Finance Committee, Machine Advisory Committee, Scientific Advisory Committee, In-Kind Review Committee, Detector Advisory Committee, Laser Advisory Committee, and Advisory Review Teams for scientific instruments as well as for X-ray optics and beam transport systems.

Administrative and Finance Committee (AFC)	
Chairman	Leif Eriksson (Swedish Research Council, Stockholm, Sweden)
Vice Chairman	Xavier Reymond (State Secretariat for Education, Research, and Innovation, Bern, Switzerland)
Delegates	
Denmark	Anders Kjær (DASTI, Copenhagen) and Troels Rasmussen (DASTI, Copenhagen)
France	Bertrand Franel (CEA, Paris) and Laurent Pinon (CNRS, Paris)
Germany	Michael Budke (BMBF, Bonn) and Christian Scherf (DESY, Hamburg)
Hungary	Barbara Tóth-Vizkelety (NIH, Budapest)
Poland	Zbigniew Gołębiewski (NCBJ, Otwock-Świerk)
Russia	Aleksandr Lvovskii (OJSC RUSNANO, Moscow) and Valeriy Nosik (NRC “Kurchatov Institute”, Moscow)
Slovakia	Pavol Sovák (P.J. Šafárik University, Košice)
Sweden	Inger Andersson (Swedish University of Agricultural Sciences, Uppsala) and Elin Swedenborg (Swedish Research Council, Stockholm)
Switzerland	Peter Allenspach (PSI, Villigen) and Xavier Reymond (State Secretariat for Education, Research, and Innovation, Bern)
Secretary	
	Uta Sprenger (European XFEL, Hamburg, Germany)
Vice Secretary	
	Liliane Pereira Bahia (European XFEL, Hamburg, Germany)

In-Kind Review Committee (IKRC)	
Chairman & Russian Delegate	Leonid V. Kravchuk (INR, Moscow, Russia)
Vice Chairman & Swiss Delegate	Volker Schlott (PSI, Villigen, Switzerland)
Members	
Denmark	Søren Schmidt (DTU, Kongens Lyngby)
France	Alex C. Mueller (CNRS, Paris)
Germany	Reinhard Brinkmann (DESY, Hamburg)
Hungary	Gyula Faigel (Wigner Research Centre for Physics, Hungarian Academy of Sciences, Budapest)
Italy	Carlo Pagani (INFN Sezione di Milano, LASA, Milano)
Poland	Krzysztof Meissner (NCBJ, Otwock-Świerk)
Slovakia	Stefan Molokac (Cryosoft Ltd, Košice)
Spain	Teresa Martínez De Álvaro (CIEMAT, Madrid)
Sweden	Håkan Danared (ESS AB, Lund)
European XFEL GmbH	Andreas S. Schwarz (for the accelerators) and Thomas Tschentscher (for the beamlines)
Secretaries	
	Serge Prat (European XFEL, Hamburg, Germany) until 31 July 2014 Antonio Bonucci (European XFEL, Hamburg, Germany) since 1 September 2014
Lawyer	
	Malte Laub (European XFEL, Hamburg, Germany)

Machine Advisory Committee (MAC)	
Chairman	Richard Walker (Diamond Synchrotron, Oxfordshire, United Kingdom)
Members	
	Caterina Biscari (CELLS–ALBA, Cerdanyola del Vallès, Spain) since 24 October 2014
	Hans-Heinrich Braun (PSI, Villigen, Switzerland)
	Massimo Ferrario (INFN, Frascati, Italy) until 23 October 2014
	Camille Ginsburg (Fermilab, Batavia, Illinois) since 24 October 2014
	Zhirong Huang (SLAC, Menlo Park, California)
	Andreas Jankowiak (HZB, Berlin, Germany)
	Leonid V. Kravchuk (INR, Moscow, Russia)
	Jacek Krzywinski (SLAC, Menlo Park, California) until 23 October 2014
	John Mammosser (Jefferson Lab, Newport News, Virginia)
	Pantaleo Raimondi (ESRF, Grenoble, France)
	Félix Rodríguez Mateos (CERN, Geneva, Switzerland)

Scientific Advisory Committee (SAC)	
Chairman	Rafael Abela (PSI, Villigen, Switzerland)
Members	
	Patrick Audebert (LULI, École Polytechnique, Palaiseau, France)
	Stefan Eisebitt (HZB, Berlin, Germany)
	Gyula Faigel (Wigner Research Centre for Physics, Hungarian Academy of Sciences, Budapest)
	Salvador Ferrer (CELLS–ALBA, Cerdanyola de Vallès, Spain) until 23 October 2014
	Gerhard Grübel (DESY, Hamburg, Germany) since 24 October 2014
	Jerome Hastings (SLAC, Menlo Park, California)
	Ursula Keller (ETH Zürich, Switzerland)
	Maya Kiskinova (Elettra Sincrotrone Trieste, Italy) since 24 October 2014
	Inari Kursula (University of Oulu, Finland; CSSB, Hamburg, Germany) since 24 October 2014
	Sine Larsen (University of Copenhagen, Denmark) until 23 October 2014
	Anders Nilsson (Stockholm University, Sweden) since 24 October 2014
	Joseph Nordgren (Uppsala University, Sweden) until 23 October 2014
	Natalia Novikova (IC RAS, Moscow, Russia)
	Aymeric Robert (LCLS, SLAC, Menlo Park, California) until 23 October 2014
	Ilme Schlichting (MPI for Medical Research, Heidelberg, Germany) since 24 October 2014
	Francesco Sette (ESRF, Grenoble, France)

Scientific Advisory Committee (SAC) (continued)

David Stuart (University of Oxford and Diamond Synchrotron, Oxfordshire, United Kingdom)

Edgar Weckert (DESY, Hamburg, Germany)
until 23 October 2014

Linda Young (ANL, Argonne, Illinois)

Secretary

Gianluca Geloni (European XFEL, Hamburg, Germany)

Detector Advisory Committee (DAC)

Chairman Jörn Wilms (University of Erlangen, Germany)

Members

Roland Horisberger (PSI, Villigen, Switzerland)

Christopher J. Kenney (SLAC, Menlo Park, California)

Jörg Klorá (ITER, St. Paul-lez-Durance, France)

David Quarrie (LBNL, Berkeley, California)

John Arthur (SLAC, Menlo Park, California)

Jens Meyer (ESRF, Grenoble, France)

Eric Eikenberry (DECTRIS Ltd., Baden, Switzerland)

Laser Advisory Committee (LAC)	
Chairman	Uwe Morgner (Laser Zentrum Hannover, Germany)
Members	
	Giulio Cerullo (Politecnico di Milano, Italy)
	Mike Dunne (SLAC, Menlo Park, California)
	Patrick Georges (Institut d'Optique, Paris, France)
	Alfred Leitenstorfer (Universität Konstanz, Germany)
	Robert Schoenlein (LBNL, Berkeley, California)
	William E. White (SLAC, Menlo Park, California)
Secretaries	
	Oliver Mücke (CFEL and DESY, Hamburg, Germany) Andreas Galler (European XFEL, Hamburg, Germany)

Advisory Review Team (ART) – Scientific Instrument FXE	
Chairman	Martin Meedom Nielsen (DTU, Kongens Lyngby, Denmark)
Members	
Reporter to SAC	Rafael Abela (PSI, Villigen, Switzerland)
	David Fritz (SLAC, Menlo Park, California)
	Pieter Glatzel (ESRF, Grenoble, France)
	Steven L. Johnson (ETH Zürich, Switzerland)
	Alke Meents (DESY, Hamburg, Germany)
	Simone Techert (MPI for Biophysical Chemistry, Göttingen, and DESY, Hamburg, Germany)
Guest	Aymeric Robert (LCLS, SLAC, Menlo Park, California)

Advisory Review Team (ART)—Scientific Instrument HED

Chairman Richard W. Lee (SLAC, Menlo Park, California)

Members

Patrick Audebert (LULI, École Polytechnique, Palaiseau, France)

Andrew Higginbotham (University of Oxford, United Kingdom)

Hae Ja Lee (SLAC, Menlo Park, California)

Hanns-Peter Liermann (DESY, Hamburg, Germany)

David Neely (STFC, Oxfordshire, United Kingdom)

Paul Neumayer (GSI, Darmstadt, Germany)

Klaus Sokolowski-Tinten (Universität Duisburg-Essen, Germany)

Sven Toleikis (DESY, Hamburg, Germany)

Advisory Review Team (ART)—Scientific Instrument MID

Chairman Jerome Hastings (SLAC, Menlo Park, California)

Members

Gerhard Grübel (DESY, Hamburg, Germany)

Henning Friis Poulsen (Risø DTU, Roskilde, Denmark)

Ian K. Robinson (UCL, London, United Kingdom)

Giancarlo Ruocco (Sapienza – Università di Roma, Italy)

Tim Salditt (Georg-August-Universität Göttingen, Germany)

Advisory Review Team (ART)—Scientific Instrument SCS	
Chairman	Jan Lüning (Université Pierre et Marie Curie, Paris, France; Synchrotron SOLEIL, Saint Aubin, France)
Members	
Reporter to SAC	Stefan Eisebitt (HZB, Berlin, Germany)
	Giacomo Ghiringhelli (Politecnico di Milano, Italy)
	Gerhard Grübel (DESY, Hamburg, Germany)
	Nina Rohringer (CFEL and DESY, Hamburg, Germany)
	William F. Schlotter (LCLS, SLAC, Menlo Park, California)
	Wilfried Wurth (DESY, Hamburg, Germany)

Advisory Review Team (ART)—Scientific Instrument SPB/SFX	
Chairman	David Stuart (University of Oxford and Diamond Synchrotron, Oxfordshire, United Kingdom)
Members	
	Anton Barty (CFEL and DESY, Hamburg, Germany)
	Sebastien Boutet (LCLS, SLAC, Menlo Park, California)
	Daniel DePonte (LCLS, SLAC, Menlo Park, California)
	Victor Lamzin (EMBL, Hamburg, Germany)
	Ilme Schlichting (MPI for Medical Research, Heidelberg, Germany)
	Garth Williams (LCLS, SLAC, Menlo Park, California)

Advisory Review Team (ART)—Scientific Instrument SQS

Chairman Thomas Möller (TU Berlin, Germany)

Members

John Bozek (Synchrotron SOLEIL, Saint Aubin, France)

Reinhard Dörner (Goethe Universität, Frankfurt am Main, Germany)

Joseph Nordgren (Uppsala University, Sweden)

Henrik Pedersen (Aarhus University, Denmark)

Artem Rudenko (Kansas State University, Manhattan, Kansas)

Jens Viefhaus (DESY, Hamburg, Germany)

Marc Vrakking (MBI, Berlin, Germany)

Advisory Review Team (ART)—X-Ray Optics and Beam Transport

Chairman Christian Schroer (DESY, Hamburg, Germany)

Members

Ray Barrett (ESRF, Grenoble, France)

Rolf Follath (PSI, Villigen, Switzerland)

Aymeric Robert (LCLS, SLAC, Menlo Park, California)

Horst Schulte-Schrepping (DESY, Hamburg, Germany)

Edgar Weckert (DESY, Hamburg, Germany)

Timm Weitkamp (Synchrotron SOLEIL, Saint Aubin, France)

COOPERATION

European XFEL has established an extensive international research network with partners around the world. Cooperation and partnership agreements with research organizations serve to further advance X-ray laser science and help scientists to prepare for the unique research opportunities at the new research facility. In 2014, European XFEL signed a Memorandum of Understanding (MoU) with the University of Osaka, a collaboration agreement with the University of Rostock, and a research agreement with the Max Planck Society.

Cooperations with research institutions



CLPU

European XFEL and the Spanish Center for Ultrashort Ultraintense Pulsed Lasers (CLPU) in Salamanca cooperate to develop new ultrafast optical lasers to analyse physical and chemical processes in conjunction with the X-ray beams of the European XFEL. In combination with the unique features of the European XFEL, new optical laser technologies will enable scientists to film ultrafast processes, such as chemical and biochemical reactions that provide a basis for the development of more efficient industrial production processes or new medical products and devices. An MoU was signed on 10 October 2011.



CNRS

In addition to becoming a shareholder of European XFEL in 2014, Centre National de la Recherche Scientifique (CNRS), one France's largest research organizations, signed a collaboration agreement with European XFEL regarding the design, development, construction, and delivery of a MHz prototype non-collinear optical parametric amplifier (NOPA) through the Cluster of Research Infrastructures for Synergies in Physics (CRISP) framework.

Collaboration of European FEL and SPS facilities

European research facilities that operate or develop X-ray free-electron lasers (FELs) and advanced short-pulse and coherent light sources (SPS) cooperate to promote FEL science and technology in Europe and to provide the experimental conditions needed by a large, multidisciplinary user community. An MoU was signed in May 2012. Other members are Deutsches Elektronen-Synchrotron (DESY) in Germany, Sincrotrone Trieste (Elettra) in Italy, Helmholtz-Zentrum Berlin (HZB) in Germany, Istituto Nazionale di Fisica Nucleare (INFN) in Italy, MAX IV Laboratory in Sweden, Paul Scherrer Institut (PSI) in Switzerland, SOLEIL in France, Science and Technology Facilities Council (STFC) in the United Kingdom, and National Centre for Nuclear Research (NCBJ) in Poland.



DESY

The relationship between European XFEL and its main shareholder, Deutsches Elektronen-Synchrotron (DESY) in Germany, is unique. The two partners collaborate on the construction, commissioning, and eventual operation of the facility, based on a long-term agreement.



EMBL

European XFEL cooperates with European Molecular Biology Laboratory (EMBL), Europe's top address for biological research on the molecular level. An MoU was signed on 12 September 2011.



HAW Hamburg

European XFEL and Hamburg University of Applied Sciences (HAW Hamburg) cooperate in science and engineering education. The main focus is to give undergraduate students practical experience in their degree programmes. A cooperation agreement was signed on 2 December 2013.



HZB

An MoU for a collaboration was signed on 11 March 2010 by European XFEL and Helmholtz-Zentrum Berlin (HZB) in Germany. The goal is to establish specific collaborations to develop optical components in soft X-ray optics and diagnostics, especially with respect to the expertise at the BESSY synchrotron at HZB.

In 2013, European XFEL signed an additional cooperation agreement with HZB in the framework of the Helmholtz Virtual Institute "Dynamic Pathways in Multidimensional Landscapes" initiative.



Kurchatov Institute

European XFEL cooperates with National Research Centre "Kurchatov Institute" in Moscow, Russia, in calculating radiation parameters and organizing European XFEL schools for young scientists.



LBL

European XFEL and Lawrence Berkeley National Laboratory (LBL) in Berkeley, California, made a "Work for Others" agreement regarding detector development, with the aim of creating detectors for a possible future light source at LBNL. An MoU was signed in Hamburg on 16 April 2013.



LNLS

DESY, European XFEL, and the Brazilian synchrotron radiation laboratory (LNLS) in Campinas signed a cooperation agreement in Brasília on 5 May 2011.



Max Planck Society

On 24 November 2014, European XFEL signed a research agreement with the Max Planck Society, represented by the Semiconductor Laboratory (“Halbleiterlabor”) in Munich, Germany, on “Cooperation within the framework of the production of Silicon Drift Detector (SDD) sensors for the DSSC 1 Megapixel Detector”.



Osaka University

European XFEL and the Osaka University in Japan agreed to jointly appoint a scientist to promote education and research. An MoU was signed on 16 December 2014.



SLAC

Regular contacts with SLAC National Accelerator Laboratory in Menlo Park, California, provide an important opportunity to gain hands-on experience at an X-ray FEL in operation, the Linac Coherent Light Source (LCLS). An MoU was signed on 27 July 2009.



Southern Federal University

European XFEL and Southern Federal University in Rostov, Russia, stated their interest in establishing a joint programme in education and research.



Shubnikov Institute of Crystallography

European XFEL and Shubnikov Institute of Crystallography of the Russian Academy of Sciences (IC RAS) cooperate in the growth and handling of crystals for optical elements as well as in organizing European XFEL schools for young scientists in Moscow.



STFC

The Science and Technology Facilities Council (STFC) in Swindon, United Kingdom, develops the Large Pixel Detector (LPD) for the European XFEL as well as hardware elements for the readout and data acquisition architecture. A prolongation of a 2010 cooperation agreement was signed on 30 January 2013. The new phase of the agreement includes production of the LPD detector.



Technological Institute for Superhard and Novel Carbon Materials

European XFEL and Technological Institute for Superhard and Novel Carbon Materials (FSBI TISNCM) in Troitsk, Moscow, Russia, agreed to develop an in-line seeding monochromator for the high power and high repetition rate of the European XFEL based on synthetic diamonds. The collaboration agreement was signed in August 2012.

An additional collaboration agreement, signed in December 2014 between European XFEL, DESY, and FSBI TISNCM, establishes cooperation on accelerator physics and technology, the use of synchrotron radiation for basic and applied research, and the development and use of free-electron lasers through exchanges of information, personnel including students, and equipment.



Turkish Accelerator Center

European XFEL collaborates with the Turkish Accelerator Center (TAC) in the development of scientific instrumentation for highly coherent, ultrashort-pulse X-ray light sources and their scientific use. An MoU was signed in May 2012 with Ankara University, Turkey, the coordinator of the TAC.



University College London

The clock and control hardware for the European XFEL detectors is being developed at University College London (UCL) in the United Kingdom.



University of Hamburg

European XFEL and the School of Mathematics, Informatics and Natural Sciences (MIN) at the University of Hamburg, Germany, cooperate in research and teaching. The main focus is on exchanging know-how, implementing joint research projects, providing mutual access to experimental facilities, and promoting undergraduates, Ph.D. students, and young scientists. A contract was signed on 15 August 2011.



University of Rostock

European XFEL and the University of Rostock, Germany, agreed on a framework for cooperation and common procedures for the appointment of professors. A collaboration agreement was signed on 5 June 2014.

Figure 1
Left to right
Massimo Altarelli, Managing Director, European XFEL;
Birgit Piechulla, Vice-Rector of Research and Research Education, University of Rostock





Uppsala University

European XFEL and Uppsala University in Sweden cooperate in the field of X-ray science with a focus on structural biology. Professor Janos Hajdu acts as a senior advisor to the scientific directors of European XFEL and contributes his expertise to the realization of measuring stations and experiments. An agreement was signed on 15 October 2010.

Participation in EU programmes



CALIPSO

CALIPSO is a European Union (EU) consortium that coordinates the European synchrotrons and free-electron lasers (FELs), including the three European Strategy Forum on Research Infrastructures (ESFRI) roadmap projects—European XFEL, EuroFEL, and the ESRF Upgrade Programme—towards a fully integrated network. CALIPSO receives funding from the EU Seventh Framework Programme (FP7/2007–2013) under grant agreement n° 312284. The project began in June 2012 and will continue through December 2015. Within CALIPSO, European XFEL contributes to scientific cooperation, workshops, and joint trainings as an observer within the High-Z sensors for Pixel Array Detectors (HIZPAD2) project to improve exchange among accelerator physicists and FEL users on diagnostics techniques.



BioStruct-X

BioStruct-X is a consortium of 19 institutions from 11 EU member and associated states. Within a broader research programme, European XFEL scientists work with colleagues from leading international research centres to improve the structure determination of biomolecules. The EU project was started in 2011 and a consortium agreement specifying the relationship between the parties was signed in 2012.



CRISP

The Cluster of Research Infrastructures for Synergies in Physics (CRISP) is an EU research network of 11 European research infrastructures currently being planned or under construction. CRISP receives funding from the EU Seventh Framework Programme (FP7/2007–2013) and was launched on October 2011. A consortium agreement between the partners was signed in 2012. The network focuses on four key areas of physics: accelerator technology, physics instrumentation and experiments, detectors and data acquisition technologies, and IT and data management systems.

Memberships in research cooperations

Development and Use of Accelerator-Driven Photon Sources

European XFEL participates in the German–Russian bilateral funding programme “Development and Use of Accelerator-Driven Photon Sources”. Several projects have been approved.



EIROforum

EIROforum is a collaboration between eight European intergovernmental research organizations (EIROs): EMBL, ESRF, European Fusion Development Agreement—Joint European Torus (EFDA-JET), European Organization for Nuclear Research (CERN), European Southern Observatory (ESO), European Space Agency (ESA), European XFEL, and Institut Laue-Langevin (ILL). The mission of EIROforum is to combine resources, facilities, and expertise to support European science in reaching its full potential. EIROforum also publishes a free journal, *Science in School*, which promotes inspiring science teaching.

Hard X-ray FEL collaboration

The LCLS; the SPring-8 Angstrom Compact Free Electron Laser (SACLA) in Hyogo, Japan; the future Swiss Free-Electron Laser (SwissFEL) in Villigen, Switzerland; the future Pohang Accelerator Laboratory X-Ray Free-Electron Laser (PAL-XFEL); and the Hamburg FEL projects (FLASH at DESY and European XFEL) collaborate, share project information, and identify topics of common interest in a meeting series. In 2014, the collaboration’s meeting was hosted by European XFEL (see Chapter 9, “Scientific Record”).

Physics on Accelerators and Reactors of Western Europe

In November 2010, European XFEL joined the “Physics on Accelerators and Reactors of Western Europe” programme of the Russian Ministry of Education and Science. The programme funds research stays of Russian scientists at large leading European research facilities.

USER CONSORTIA

User consortia contribute to the construction of scientific instruments, to the ancillary instrumentation, and to the technical infrastructure.

Currently, seven proposals have been approved by the European XFEL Council:

- The **Integrated Biology Infrastructure Life-Science Facility at the European XFEL (XBI)** is a proposal for an integrated structural-biology infrastructure—including laboratory space, sample characterization technique, and operation staff—in the European XFEL headquarters building (XHQ). This proposal is led by European Molecular Biology Laboratory (EMBL) and includes Deutsches Elektronen-Synchrotron (DESY), a research centre of the Helmholtz Association.
- The **Serial Femtosecond Crystallography (SFX)** user consortium proposes to build a second interaction chamber for nanocrystallography and sample screening in the Single Particles, Clusters, and Biomolecules and Serial Femtosecond Crystallography (SPB/SFX) instrument hut, reusing the transmitted X-ray free-electron laser (FEL) beam. This proposal is led by DESY.
- **DataXpress** is a user consortium providing a data analysis toolkit and hardware aiming at solving the data and reconstruction challenge for single-particle and nanocrystal coherent diffraction experiments at the European XFEL. This proposal is led by DESY.
- The **CircPol** user consortium seeks to build afterburner undulators to create X-ray pulses with controllable polarization states by exploiting the electron beam microbunching generated in the baseline European XFEL undulators. This proposal is led by Budker Institute of Nuclear Physics (BINP) in Novosibirsk, Russia.
- The **Helmholtz International Beamline for Extreme Fields at the European XFEL (HIBEF)** user consortium proposes to contribute two high-energy optical lasers, a high-field pulsed magnet instrument, and a number of scattering diagnostics to be integrated into the High Energy Density Science (HED) instrument. A laser building could house future upgrades of these optical lasers and would provide offices for the staff to build up and operate these systems. This proposal is led by Helmholtz-Zentrum Dresden-Rossendorf (HZDR), Germany, and includes DESY, both research centres of the Helmholtz Association.
- The **COMO** consortium addresses the provision of state-, size-, and isomer-selected samples of polar molecules and clusters for studies using soft and hard X-ray FEL radiation. It intends to build an additional chamber that can be attached to the European XFEL instruments, in particular the Small Quantum Systems (SQS) and the SPB/SFX instruments. This proposal is led by DESY.
- The **Heisenberg Resonant Inelastic X-ray Scattering (h-RIXS)** user consortium proposes to build high-resolution spectrometers complementing the capabilities of the Spectroscopy and Coherent Scattering (SCS) instrument and facilitate RIXS-type experiments. This proposal is led by Helmholtz-Zentrum Berlin (HZB), a research centre of the Helmholtz Association. ■

SHORT HISTORY OF EUROPEAN XFEL

In the 1990s, Deutsches Elektronen-Synchrotron (DESY) and international partners developed a proposal for a new research institution in the Hamburg area: a large-scale facility comprising a linear collider for particle physics and an X-ray free-electron laser (FEL) for photon science. The X-ray FEL part of the project, as a European facility to be implemented in collaboration with other countries, got the go-ahead from the German Ministry of Education and Research (BMBF) in 2003. The new research institution was formally established in late 2009 with the signature of the intergovernmental Convention by an initial group of 10 countries and the foundation of the European X-Ray Free-Electron Laser Facility GmbH, a non-profit limited liability company under German law in charge of the construction and operation of the European XFEL facility.

1980–1984

The idea of a single-pass FEL for short wavelengths is introduced in the independent work of A. M. Kondratenko and E. L. Saldin (1980) and R. Bonifacio, C. Pellegrini, and L. M. Narducci (1984). The latter authors coin the term “self-amplified spontaneous emission”, or “SASE”, to describe the amplification process on which the European XFEL will eventually rely.

1992

In an international collaboration at a test facility at DESY, scientists begin to develop and test the technology for the Tera-Electronvolt Energy Superconducting Linear Accelerator (TESLA) project. This technology will eventually form the basis for the European XFEL.

1997

The international TESLA collaboration led by DESY publishes a conceptual design report for TESLA, a linear collider with an integrated X-ray laser facility.



Figure 1 Experiment section of the TESLA test facility at DESY in 1997

2000

Scientists at the TESLA test facility at DESY achieve a world first by generating shortwave laser light in the ultraviolet range (80–180 nm) using the pioneering SASE FEL principle on which the European XFEL is based.



Figure 2 Accelerator section of the TESLA test facility at DESY in 1999



Figure 3 On 22 February 2000, the free-electron laser at the TESLA test facility produces a laser beam for the first time—with the shortest wavelengths ever generated by a free-electron laser.

2001

The TESLA collaboration publishes a technical design report (TDR) for TESLA.

The FEL at the TESLA test facility demonstrates the greatest possible light amplification at 98 nm. A user programme with first experiments starts soon afterwards.

2002

A TDR for an X-ray laser laboratory with a dedicated linear accelerator in a separate tunnel is published as a supplement to the TESLA TDR.



Figure 4 Supplement to the TESLA TDR

2003

The German government decides to cover around half of the investment costs for the dedicated X-ray laser facility described in the TESLA TDR supplement, provided the rest is borne by European partner countries. This decision leads to intense negotiations on funding and participation.

A site near DESY is chosen for the new X-ray laser facility, so it can make use of existing DESY infrastructure.

The 100 m long TESLA test facility is extended to a total length of 260 m and modified into an FEL user facility for photon science experiments with vacuum-ultraviolet and soft X-ray radiation.

2004

The German federal states of Hamburg and Schleswig-Holstein ratify a treaty that provides the legal basis for the construction and operation of the X-ray laser facility. Among other things, the states agree on a joint public planning approval procedure, including an environmental impact assessment.



Figure 5 On 29 September 2004, Schleswig-Holstein's Minister President Heide Simonis (right) and Hamburg's Mayor Ole von Beust sign a state treaty that provides the legal basis for the construction and operation of the X-ray laser.

2005

At the beginning of the year, nine countries—France, Germany, Greece, Italy, Poland, Spain, Sweden, Switzerland, and the UK—sign a Memorandum of Understanding (MoU) in which they agree to work jointly on a governmental agreement for the construction and operation of the X-ray laser facility. Together with Denmark, Hungary, the Netherlands, Russia, Slovakia, and the European Union (EU), whose representatives are present as observers, the signatory countries form an International Steering Committee (ISC) that coordinates the preparations for the construction of the X-ray laser. By the end of the year, the MoU has also been signed by China, Denmark, Hungary, and Russia.

User operation begins at the new 260 m long DESY FEL facility, which is also used for studies and technological developments related to future projects, such as the European XFEL. Soon afterwards, the facility, which has been setting new records for the shortest

wavelength ever produced with an FEL, is renamed the “Free-Electron Laser in Hamburg”, or “FLASH”.



Figure 6 On 27 April 2005, DESY directors Jochen Schneider (centre) and Albrecht Wagner (right) hand over the planning documents for the European XFEL project and the application letter initiating the public planning approval procedure to Friedhelm Wiegel, the representative of the State Authority for Mining, Energy and Geology of Lower Saxony.

2006

In July, the DESY XFEL project group and the European XFEL project team, established in Hamburg through the MoU, publish a TDR for the proposed European XFEL facility. In 580 pages, 270 authors from 69 institutes in 17 countries describe the scientific and technical details of the research facility.

In August, the State Authority for Mining, Energy and Geology (LBEG) of Lower Saxony, which is in charge of the public planning approval procedure for the European XFEL, gives the formal go-ahead for the realization of the facility.

In October, the European Strategy Forum on Research Infrastructures (ESFRI) committee of the EU publishes the first European roadmap for new large-scale research infrastructures. The European XFEL facility is among the first of the 35 projects on the list to proceed to the construction phase.



Figure 7 On 25 July 2006, representatives of European XFEL and DESY hand over the European XFEL TDR to the chairman of the International Steering Committee (ISC).
Left to right Jochen R. Schneider, Albrecht Wagner, Hermann Schunck (BMBF), Massimo Altarelli, Karl Witte, Andreas S. Schwarz, Reinhard Brinkmann, and Thomas Delissen

2007

In January, 260 scientists from 22 countries meet at DESY in Hamburg for the first European XFEL Users' Meeting.

In June, the German research ministry officially launches the European XFEL. Germany and the 12 interested partner countries—China, Denmark, France, Greece, Hungary, Italy, Poland, Russia, Spain, Sweden, Switzerland, and the UK—agree to construct a startup version of the facility, comprising 6 of 10 scientific instruments, with the aim to upgrade it as soon as possible to the complete facility with 10 instruments. The launch signals the start of the calls for tender for civil construction.

In July, the four-year Pre-XFEL project is launched. This project is funded by the EU and designed to support the foundation of the European XFEL as a major new research institution in Europe. The main purpose of the project is to provide all technical, legal, and financial documents necessary for the foundation of a company to build and operate the European XFEL facility. Other Pre-XFEL activities include recruiting international staff, informing potential users about the European XFEL, and facilitating the specification, research and development, prototyping, and industrialization required to build the technical infrastructure and components for the facility

In October, Slovakia officially joins the European XFEL project by signing the MoU.



Figure 8 The European XFEL is officially launched on 5 June 2007.

Left Valérie Pécresse, French Minister of Higher Education and Research; Peter Harry Carstensen, Minister President of Schleswig-Holstein; Annette Schavan, German Federal Minister of Education and Research; Ole von Beust, Mayor of the City of Hamburg; and Andrej A. Fursenko, Minister of Education and Science of the Russian Federation

Right Annette Schavan, Ole von Beust, and Peter Harry Carstensen

2008

In September, the European XFEL ISC adopts the contents of the “Convention concerning the Construction and Operation of a European X-ray Free-Electron Laser Facility”, the legal foundation of the European XFEL GmbH.

In December, contracts are awarded for civil engineering works at the three European XFEL sites: Schenefeld (Schleswig-Holstein), Osdorfer Born (Hamburg), and DESY-Bahrenfeld (Hamburg).



Figure 9 Signing of the building contracts for the three underground construction lots for the European XFEL facility on 12 December 2008



Figure 10 In 2008, European XFEL moves into its current headquarters at Albert-Einstein-Ring 19, near the DESY site.

2009

In January, construction of the European XFEL facility officially starts in Schenefeld, Osdorfer Born, and DESY-Bahrenfeld.

In October, the European X-Ray Free-Electron Laser Facility GmbH is officially registered in the Hamburg commercial register.

In November, representatives from 10 partner countries—Denmark, Germany, Greece, Hungary, Italy, Poland, Russia, Slovakia, Sweden, and Switzerland—sign the European XFEL Convention and Final Act in the Hamburg city hall, thus establishing the European XFEL GmbH.



Figure 11 On 30 November 2009, representatives from 10 partner countries sign the European XFEL Convention and Final Act.

Left to right Mauro Dell'Ambrogio, State Secretary, State Secretariat for Education and Research, Switzerland; Peter Honeth, State Secretary, Ministry of Education and Research, Sweden; Andrej A. Fursenko, Minister of Education and Science of the Russian Federation; Prof. Jerzy Szwed, Undersecretary of State, Ministry of Science and Higher Education, Poland; Ole von Beust, Mayor of Hamburg; Giuseppe Pizza, State Secretary, Ministry for Education, Universities and Research, Italy; Prof. Frieder Meyer-Krahmer, State Secretary, Federal Ministry for Education and Research, Germany; Dr. Peter Ammon, State Secretary, Federal Foreign Office, Germany; Prof. Mikuláš Šupín, Director General, Division of Science and Technology, Ministry of Education of the Slovak Republic; Dr. Christos Vasilakos, Representative of the General Secretariat for Research and Technology in the Permanent Delegation of Greece at the European Union; István Varga, Minister for National Development and Economy, Hungary; Hans Müller Pedersen, Deputy Director General of the Danish Agency for Science, Technology and Innovation; and Peter Harry Carstensen, Minister President of Schleswig-Holstein

2010

In February, France signs the European XFEL Convention and Final Act, thereby bringing the number of partner countries to 11.

In May, European XFEL and DESY sign a long-term agreement on future collaboration. DESY has played an important role in fostering the X-ray laser project. It advanced the funding for the preparatory work and hosted the European XFEL project team. DESY will continue to provide administrative services and lead the international Accelerator Consortium that is constructing the 1.7 km long superconducting accelerator, including the electron source. After completion, DESY will take over the operation of the accelerator on behalf of European XFEL.

In July, the first tunnel boring machine powers up and construction of the tunnels for the European XFEL begins.

By the end of the year, Denmark, Germany, Poland, Russia, Slovakia, and Sweden have appointed shareholders to join the European XFEL GmbH. (For a complete list of shareholders, see “Shareholders” earlier in this chapter.)



Figure 12 First tunnel and borer christening ceremony on the European XFEL construction site Schenefeld on 30 June 2010

2011

In January, the second tunnel boring machine for the European XFEL starts drilling the photon tunnels beneath the Schenefeld campus.

In June, the first topping-out ceremony for one of the underground buildings of the European XFEL facility is celebrated on the DESY-Bahrenfeld construction site.

Scientists demonstrate that the parameters of the X-ray flashes generated by the new facility can be improved beyond the original design, based on research at SLAC National Accelerator Laboratory in Menlo Park, California, and DESY in Zeuthen.

At the end of the month, the Pre-XFEL project is officially concluded. All remaining duties and tasks are officially handed over to the European XFEL GmbH.

In July, the first tunnel boring machine reaches its final destination on the DESY-Bahrenfeld site, thereby completing the 2010 m long tunnel for the accelerator.

In October, Spain signs the European XFEL Convention and Final Act, thereby bringing the number of partner countries to 12.



Figure 13 First tunnel boring machine after its arrival in the final shaft

2012

In February, construction of the 2010 m long accelerator tunnel of the European XFEL facility, including the concrete floor, is completed.

In May, research activities resume at one of Hamburg's deepest underground workplaces. Three research teams contributing to the European XFEL move into their laboratories in a former experiment building of the Hadron-Electron Ring Accelerator (HERA), a particle accelerator at DESY that was switched off in summer 2007.

In June, an important milestone is reached: the construction of the whole network of tunnels is completed according to plan. The event is marked by a celebration with more than 400 participants—including guests from politics and science, as well as staff from collaborating companies.

In July, about 200 scientists from more than 20 countries in Europe, America, and Asia participate in the "Science at FELs" conference, the world's first major international conference dedicated exclusively to science with X-ray free-electron lasers. The conference is organized jointly by DESY and European XFEL.

In December 2012, Gianluca Geloni (European XFEL), Vitali Kocharyan (DESY), Evgeni Saldin (DESY), and Paul Emma (Lawrence Berkeley National Laboratory) are awarded the Innovation Award on Synchrotron Radiation by the Association of Friends of Helmholtz-Zentrum Berlin. They are honoured for their invention of a self-seeding method that significantly improves X-ray free-electron lasers.



Figure 14 Arrival of the second tunnel boring machine in the final reception shaft on 4 June 2012

2013

In June, another milestone is reached: the underground civil engineering work for the European XFEL has been completed, and the underground construction is almost finished. Over three years, about 3500 construction workers have moved more than 500 000 m³ of earth and used 150 000 m³ of concrete and 28 t of steel for underground construction. About 300 guests from politics, academia, administration, and business gather to celebrate in Schenefeld.

In September, the installation of the European XFEL injector begins at the DESY-Bahrenfeld site. The injector includes a special high-precision, water-cooled electron source, called a radio frequency gun.

In December, more than half of the European XFEL's 92 undulator segments are fully tuned. Tuned segments are placed into storage, awaiting installation in the tunnels.



Figure 15 Celebration of the end of underground construction at the Schenefeld site on 6 June 2013

2014

In May, the X-Ray Optics and Beam Transport group installs the first components of the X-ray laser's photon system in the photon tunnels.

Also in May, construction of the future European XFEL laboratory and office building (XHQ) starts.

In August, the first completed and tested accelerator module is installed in the tunnel. By the end of the year, about a quarter of the 101 required modules have been produced at Commissariat à l'Énergie Atomique et aux Énergies Alternatives (CEA) in Saclay, France. Seventeen of these modules are tested at DESY in 2014.



Figure 16 The European XFEL laboratory and office building (XHQ) under construction in December 2014



Figure 17 Installation of the first completed and tested accelerator module in the tunnel in August 2014

03

CIVIL CONSTRUCTION

Civil construction in 2014 focused on the European XFEL headquarters building in Schenefeld. Other activities included basic and technical infrastructure installations and landscape planning across the facility's three sites.

Construction work at the headquarters building



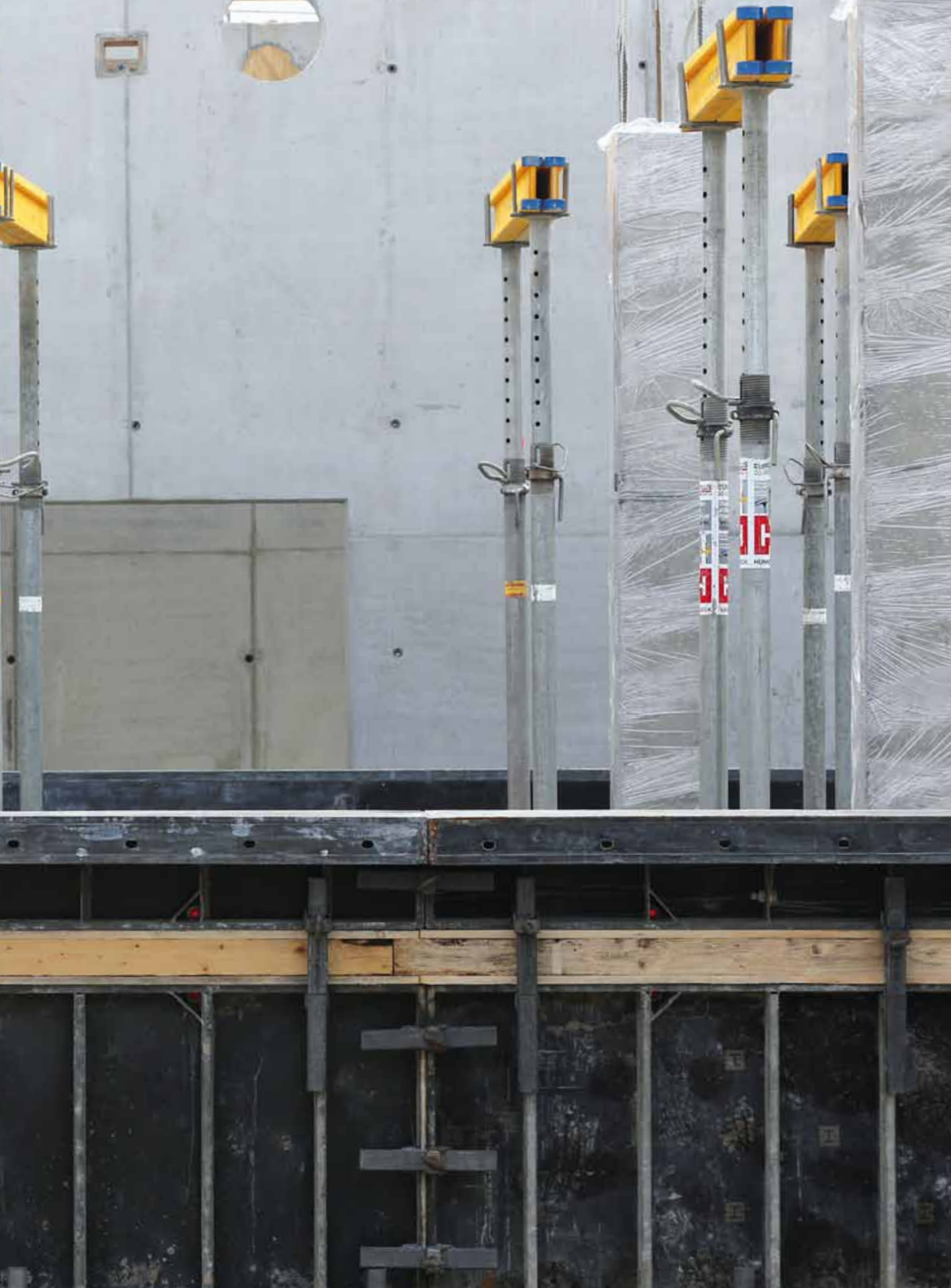

03 CIVIL CONSTRUCTION

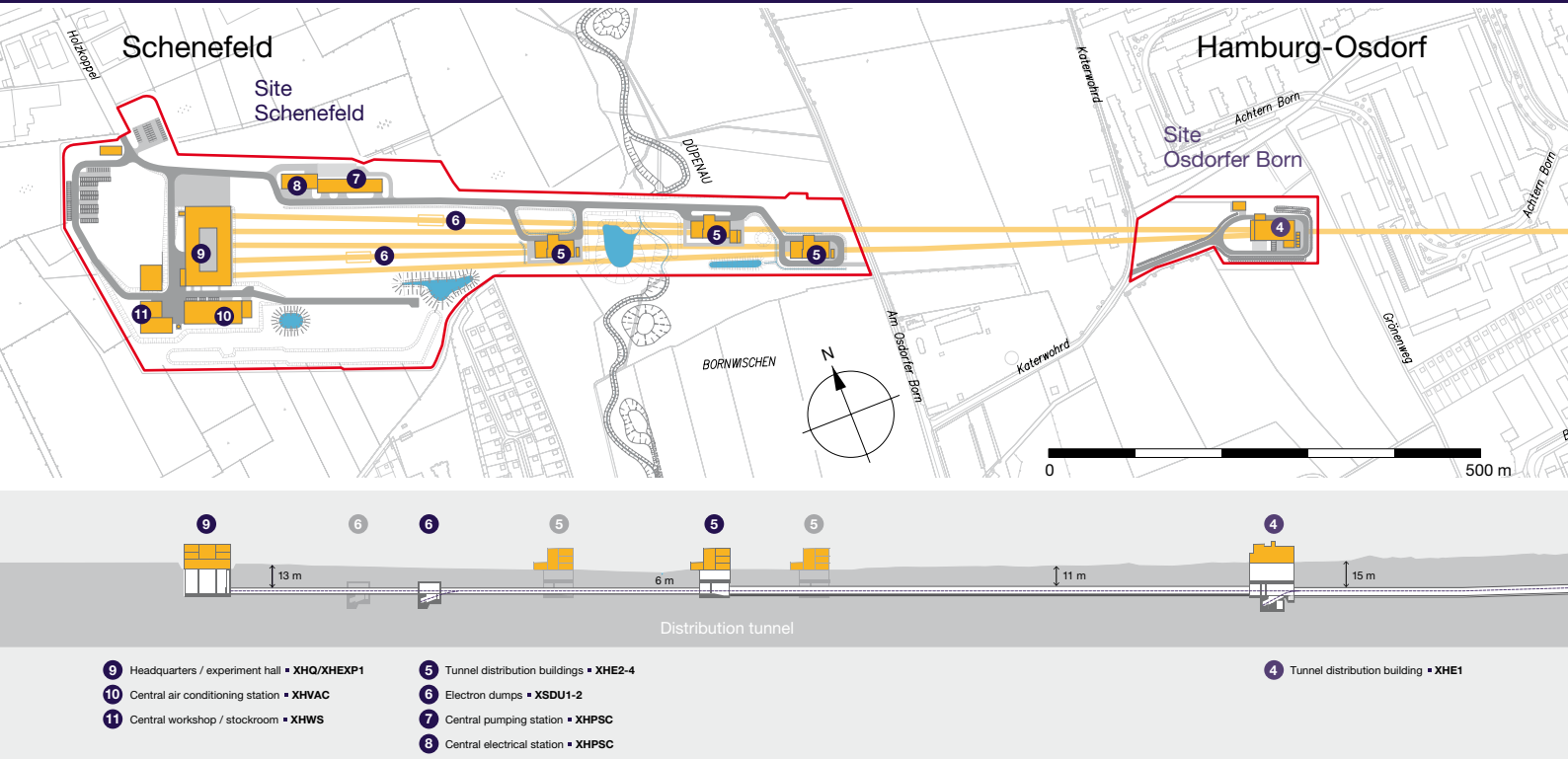

Figure 1 Layout of the European XFEL facility

CIVIL CONSTRUCTION

In 2014, civil construction began to enter its final phase with the beginning of construction of the headquarters building in Schenefeld. By year's end, the first two floors of the three-floor structure, which will house laboratory spaces and some of the facility's offices, were built. With the above-ground halls on the DESY-Bahrenfeld and Osdorfer Born sites and the access halls and the air conditioning and power buildings on the Schenefeld site completed, installation of infrastructure for district heating, power, and water between the Osdorfer Born and Schenefeld sites is under way. Planning for landscaping on all three sites of the facility has begun as well.

Overview

The overall layout of the European XFEL facility is shown in Figure 1. The top view indicates the dimensions and the placement in the surrounding area. The cross-sectional side view shows the ground profile and the various shaft buildings. The facility is approximately 3.4 km long and stretches from Deutsches Elektronen-Synchrotron (DESY) in Hamburg-Bahrenfeld all the way to the southern edge of the city of Schenefeld, in the German federal state of Schleswig-Holstein. It consists of a large network of tunnels for the accelerator and the photon beamlines plus eight shaft building complexes,

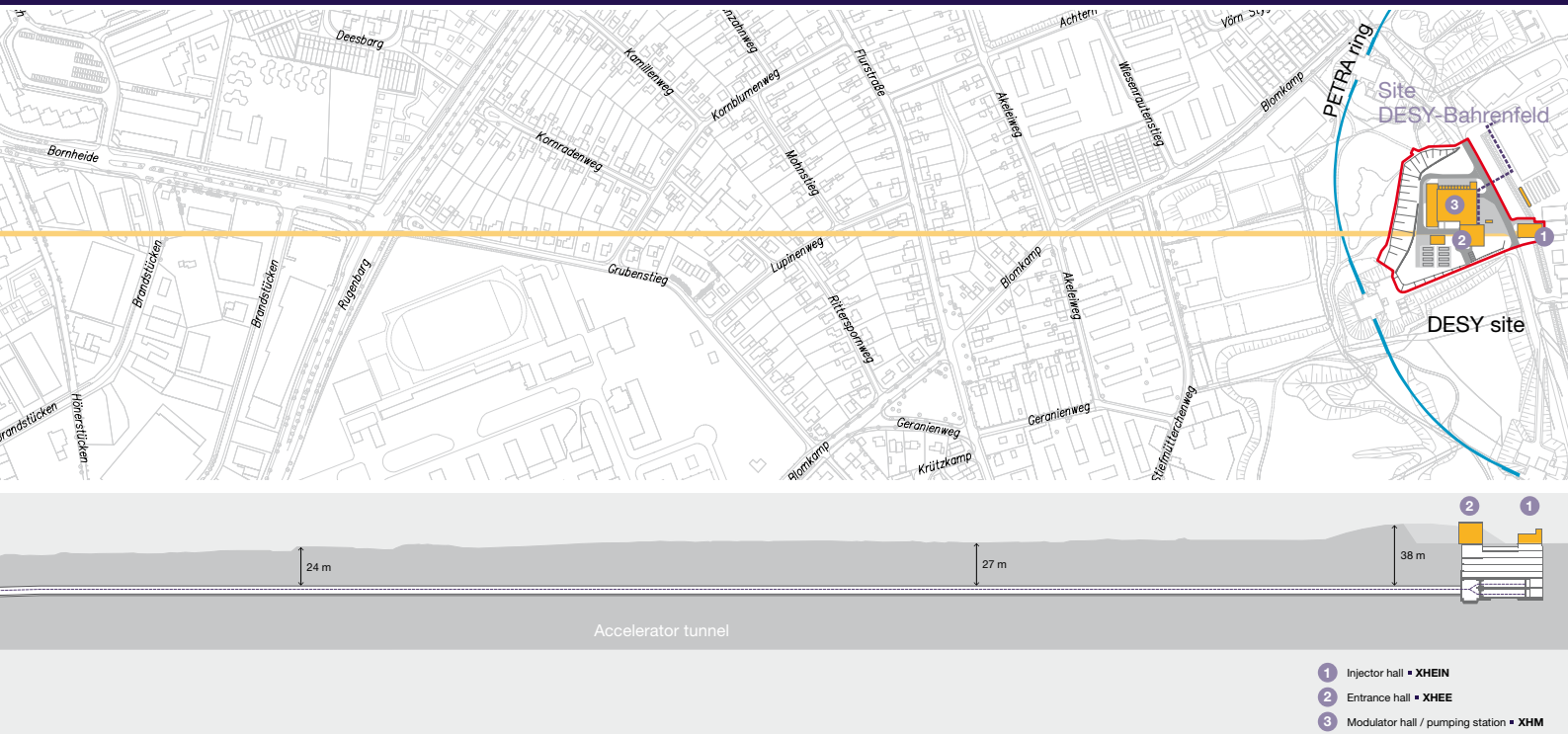

corresponding surface buildings, and assorted building structures for peripheral technical equipment (for example, pump housing, generators, and air conditioning). Most of the facility lies underground. The network of tunnels has a total length of about 5.77 km.

The heart of the facility will be the underground experiment hall in Schenefeld, with the European XFEL headquarters—a large laboratory and office building—on top. Figure 2 shows a schematic view of all the underground and surface buildings of the European XFEL facility.

Status—December 2014

After completion of the underground buildings (shafts and tunnels) in 2013 and their formal handover by the construction companies, activities in 2014 concentrated on the construction of the surface buildings at the Osdorfer Born and Schenefeld sites. In addition, work started on the planning of the infrastructure (water management, layout of piping for water, distribution of electricity, and district heating) and the overall surface layout of the Schenefeld campus.

A major milestone was the completion of the four access halls (XHE1–XHE4), the power building (XHPSC), and the air conditioning building (XHVAC). In May, construction of the laboratory and office building (XHQ) started.

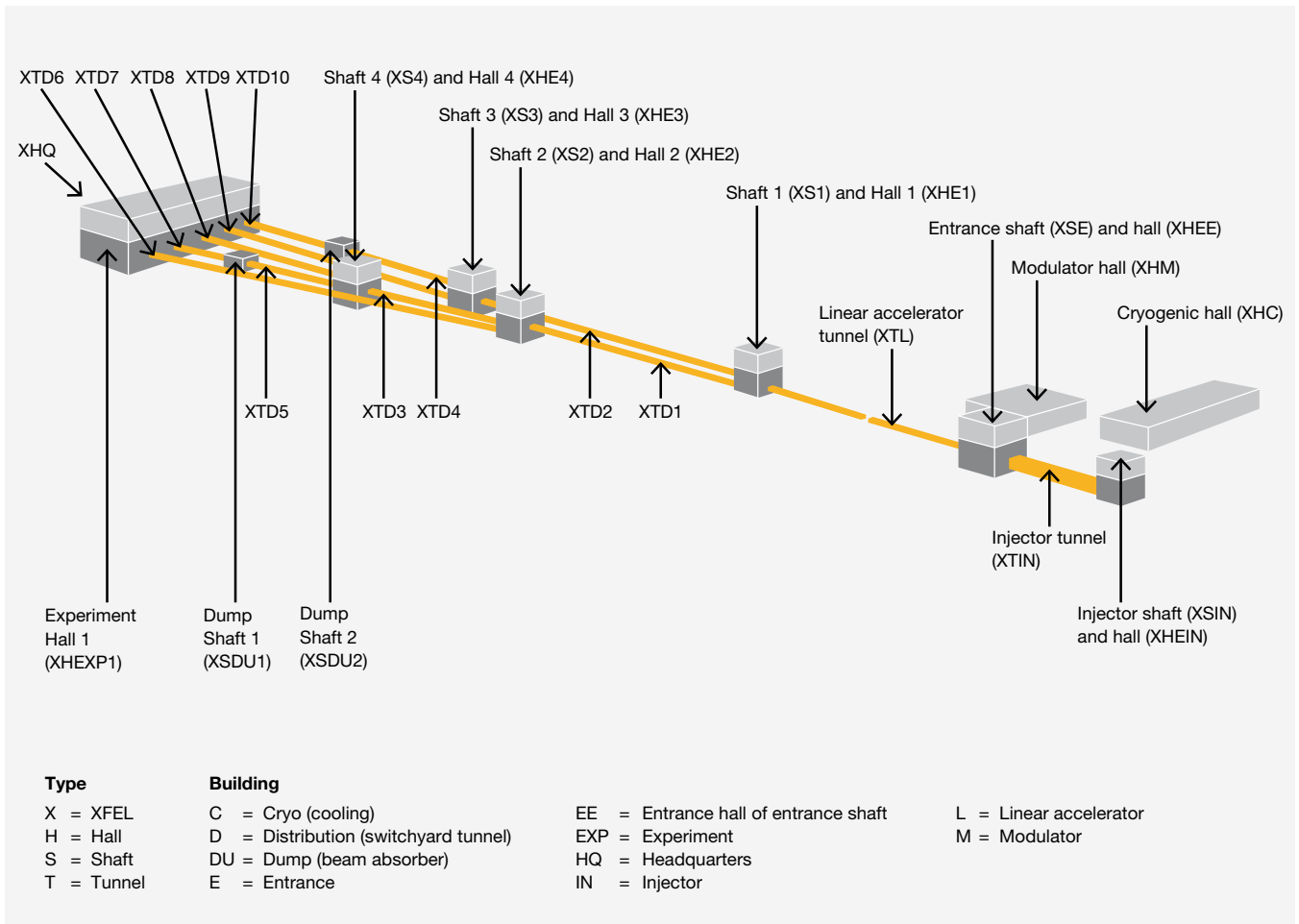

Figure 2 Buildings of the European XFEL facility

DESY-Bahrenfeld site

The civil construction work on the DESY-Bahrenfeld site was essentially finished in 2013. The technical infrastructure and components needed for the operation of the linear accelerator are now being installed in the injector complex and the modulator hall. Some of the space outside the buildings is still needed for storage of delivered components. The landscaping will be finalized after the installation work is completed.

Osdorfer Born site

Work at the Osdorfer Born site focused on the construction of the access hall (XHE1) and the district heating station. Both buildings are now finished. Work is ongoing to finalize the landscaping and the construction of the access roads. Figure 3 shows a view of the two buildings from the eastern side of the building complex in June 2014.



Figure 3 View from the eastern side of the building complex on the Osdorfer Born site (June 2014)



Figure 4 Completed media channels, located within the concrete structures, routed towards XHEXP1 on the Schenefeld campus (March 2014)

Piping was laid for routing the district heating and electricity from the Osdorfer Born site to the Schenefeld site. For part of the distance, tunnelling had to be performed in order not to interfere with existing private surface buildings. This work was completed recently. For the remainder of the distance, an open trench was excavated.



Figure 5 Artistic rendering of an aerial view of the completed Schenefeld campus with the three halls XHE2–4 in the back towards the Osdorfer Born site

Schenefeld campus

On the Schenefeld campus, XHE2–XHE4, XHVAC, and XHPSC were finished and handed over by the construction companies to European XFEL. XHPSC and XHVAC were connected to the underground experiment hall (XHEXP1) by large underground concrete media channels. Figure 4 shows, as an example, the completed media channels routed towards XHEXP1 in March 2014.

Planning of the entrance building (XHGATE) and the mechanical workshop and storage space (XHWS) has temporarily been stopped in order to free financial resources to cover deficits in other parts of the project.

Figure 5 shows an artistic rendering of the completed Schenefeld campus, and Figure 6 shows an aerial view of the entire Schenefeld construction site in July 2014. The completed halls XHE2–XHE4 can



Figure 6 Aerial view of the entire Schenefeld construction site (July 2014)

be seen in the back towards the Osdorfer Born site. The large building in the foreground (XHQ) will contain the laboratory complex for the facility on the ground floor and the offices on the first and second floor. XHPSC is visible to the left, and XHVAC to the right, of XHQ.

The start of construction of XHQ had to be postponed to reinforce the large girder grid forming the roof of XHEXP1 before putting extra weight on it through the three stories of XHQ. This was necessary because of changes in the layout of the laboratory and office floors. A reinforcement pillar was erected before work on the concrete shell of XHQ could start in May 2014.

At present, the ground floor (laboratory) and the first floor (offices) are completed. Work continues on the second floor (offices). The ground level has been sealed off with provisional windows so that the installation of the technical infrastructure can commence in early 2015.



Figure 7 North view of the XHQ construction site (July 2014)

In 2014, most of the major milestones in civil construction were met. Overall, costs for civil construction remained within the budget ceiling foreseen for the year. In 2015, most construction work will focus on completing the headquarters building.

Figure 7 shows the a view of what will become the inner court of XHQ, viewed from the south, in July 2014. The construction of the concrete shell was well under way at the end of the year, but the overall completion of XHQ is expected to be delayed by four to six months until spring or early summer 2016.

Further work has started on the Schenefeld campus concerning the laying of supply pipes between the different halls and buildings and their connection with the pipes coming from the Osdorfer Born site. Planning for the final landscaping of the campus has started, and earth-moving work has commenced in the region of the river Düpenau, where a small bridge-like structure has to be erected.

Summary and forecast

In 2014, most of the major milestones in civil construction were met. An exception was the delay in the start of construction of XHQ. This was largely caused by the additional statics calculations that had to be performed in order to check whether the concrete girder grid forming the roof of the XHEXP1 hall was sufficiently strong everywhere to support the modified and enlarged XHQ building on top of it. Overall, costs for civil construction remained within the budget ceiling foreseen for the year.

In 2015, most of the civil construction work will focus on continuing the construction of XHQ. Major efforts will be needed to finish the piping work to provide media to the individual halls and enable climatization and heating of the underground facility.

If funding permits, the planning of XHGATE and XHWS will be resumed. Finally, planning and implementation will continue for the environmental compensation measures (for example, planting trees) as well as the groundwork associated with the finalization of roads, associated infrastructure, and overall landscaping. ■

04

IN-KIND CONTRIBUTIONS

Our worldwide partners contribute to the facility in the form of components or human resources. In 2014, the Accelerator Consortium completed the challenging ramp-up phase of the series production of the accelerator modules.

Accelerator modules in the AMTF hall



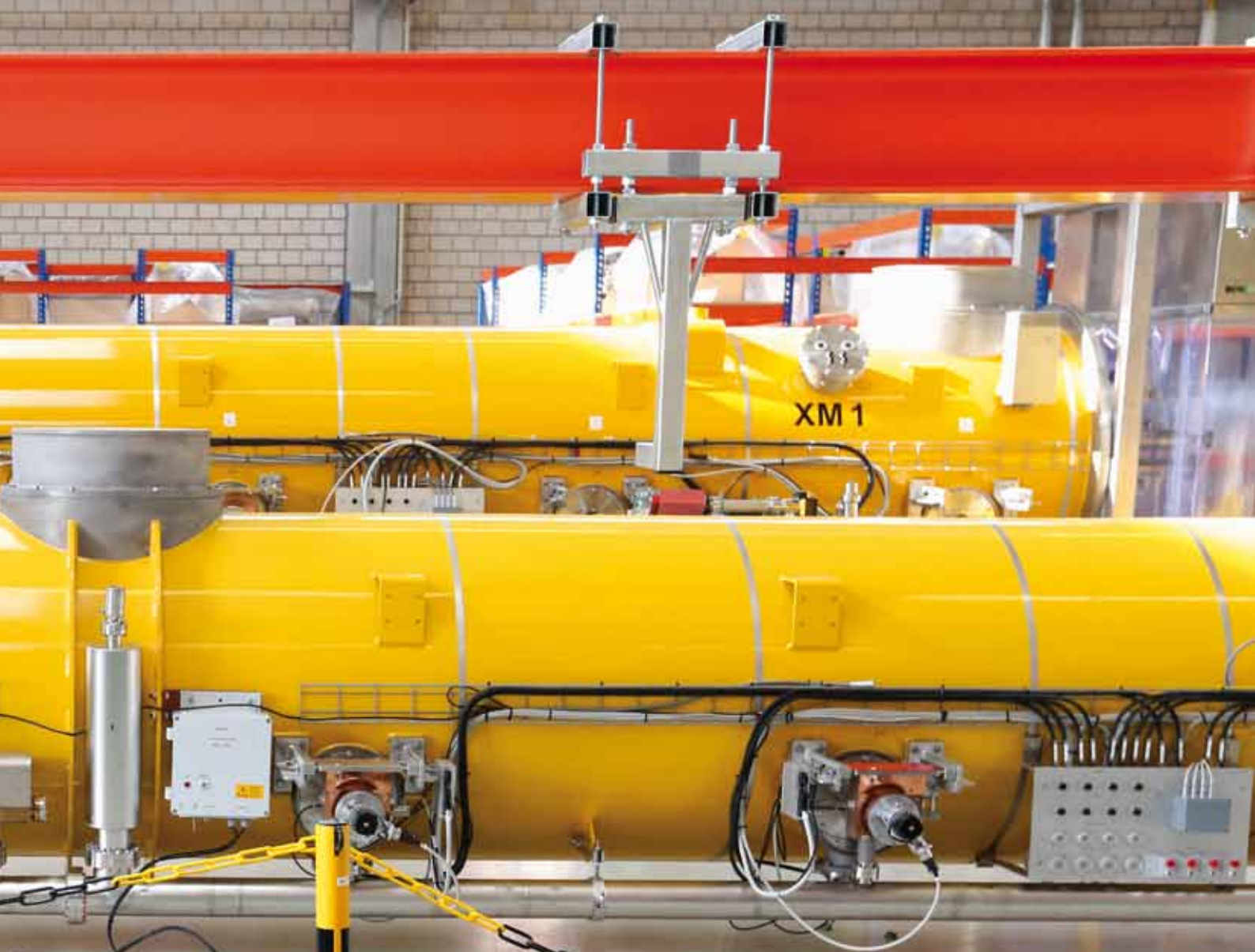

IKC OVERVIEW

European XFEL shareholders contribute to construction costs in cash or in kind. In-kind contributions (IKCs) can take the form of component delivery, secondment of staff, or both. To date, 78 IKCs by 21 institutes from 9 different countries are under way for a total of 562 million euro (M€), while a few other proposals are in preparation. Fifty-six milestones were reached in 2014. Of particular importance were the end of the production of all the cold and warm magnets and the successful tests of 491 of 540 delivered cavities and 15 of 26 delivered cryomodules at the Accelerator Module Test Facility (AMTF) by the Polish shareholder.

Overall contributions

In 2014, adjustments were made in the relative amounts of some IKCs. However, the total value of IKCs under way remains approximately 562 M€, including contracts to Russian institutes (Table 1).

Countries contributing in kind

To date, eight countries are effectively implementing IKCs: Denmark, France, Germany, Italy, Poland, Spain, Sweden, and Switzerland.

Abbreviation	Country	Number of IKCs	IKC value (k€)
DK	Denmark	2	4 087
FR	France	4	36 000
DE	Germany	36	408 802
IT	Italy	3	33 000
PL	Poland	4	15 895
RU	Russia	13	42 999
ES	Spain	4	7 811
SE	Sweden	10	4 948
CH	Switzerland	2	8 835
Total		78	562 378

Table 1 Projected IKC amounts by country (in 2005 prices) in thousands of euro (k€) as of December 2014

Russian contributions are considered somewhat differently than the IKCs from these eight countries because the Russian shareholder decided to send its full contribution to European XFEL in cash rather than in kind. Russian institutes intending to contribute to the project are awarded manufacturing contracts, which are then managed with the same procedures as IKCs. To date, European XFEL and five Russian institutes have concluded 13 manufacturing contracts.

Contributing institutes

As of December 2014, a total of 21 institutes are contributing in kind to the European XFEL facility (Table 2).

Country	Abbreviation	Institute	Location	Work packages
DK	DTU	Technical University of Denmark – Physics Department	Risø	81–84
FR	CEA	Commissariat à l'Énergie Atomique et aux Énergies Alternatives	Saclay	3, 9, 17
	CNRS	Centre National de la Recherche Scientifique	Orsay	5
DE	DESY	Deutsches Elektronen-Synchrotron	Hamburg, Zeuthen	1–5, 7–21, 28, 32–36, 38–40, 45, 46
IT	INFN	Istituto Nazionale di Fisica Nucleare	Milano	3, 4, 46
PL	NCBJ	National Centre for Nuclear Research	Świerk	6
	IFJ-PAN	Henryk Niewodniczański Institute of Nuclear Physics	Kraków	10, 11
	WUT	Wrocław University of Technology	Wrocław	10
RU	BINP	Budker Institute of Nuclear Physics of SB RAS	Novosibirsk	8, 10, 12, 13, 19, 34
	IHEP	Institute for High Energy Physics	Protvino	13, 17, 20
	INR	Institute for Nuclear Research RAS	Troitsk	18
	JINR	Joint Institute for Nuclear Research	Dubna	74
	NIIIEFA	D.V. Efremov Research Institute of Electrophysical Apparatus	St. Petersburg	12
ES	CELLS	Consortium for the Exploitation of the Synchrotron Light Laboratory	Barcelona	71
	CIEMAT	Centro de Investigaciones Energéticas, Medioambientales y Tecnológicas	Madrid	11, 71
	UPM	Universidad Politécnica de Madrid	Madrid	34
SE	KTH	Royal Institute of Technology	Stockholm	73
	MSL	Manne Siegbahn Laboratory	Stockholm	12, 71
	SU	Stockholm University	Stockholm	28, 71
	UU	Uppsala University	Uppsala	14, 79, 84, 85
CH	PSI	Paul Scherrer Institut	Villigen	16, 17

Table 2 Institutes contributing in kind to the European XFEL facility

IKRC recommendations

The In-Kind Review Committee (IKRC) advises European XFEL concerning proposed IKCs. The committee is composed of one representative from each contracting party and two representatives from European XFEL (one for the accelerator, one for the photon beamlines). Meetings of the IKRC are scheduled one to three times per year, depending on the number of proposals to discuss.

In 2014, the IKRC recommended to allocate the contribution “Components for the Scientific Instruments FXE, SPB, MID, and HED” by Technical University of Denmark (DTU) at the 2005 value of 1 227 000 €. In total, 73 proposals have received favourable recommendations from the IKRC since the start of the project.

Allocations of IKCs

Official allocation of IKCs to the proposing institutes is made after recommendation by the IKRC.

IKCs with a 2005 value below 1 M€ can be allocated directly by the European XFEL Management Board, while IKCs of higher values are allocated by the European XFEL Council after analysis and recommendation by the European XFEL Administrative and Finance Committee (AFC).

In 2014, six contributions with a total value of 25.392 M€ were allocated to the respective institutes. Since the start of the project, a total of 74 IKCs have been allocated.

Abbreviation	Institute	IKC No.	Work package	Title	Value € 2005 (2014)
DTU	Technical University of Denmark – Physics Department	DK02	81–84	Components for the scientific instruments FXE, SPB, MID, and HED	1 227 000
DESY	Deutsches Elektronen-Synchrotron, Germany	DE20	20	Beam dumps	1 360 000
		DE33	33	Tunnel installation	1 360 000
		DE34b	34	IT network systems	3 821 754
CIEMAT	Centro de Investigaciones Energéticas, Medioambientales y Tecnológicas, Spain	ES04	71	95 quadrupole movers, 95 intersection control racks, and 2 phase shifters	2 943 500
PSI	Paul Scherrer Institut, Switzerland	CH04	16	Transverse intra-bunch-train feedback system (IBFB)	2 697 000

Table 3 IKCs allocated in 2014 by the European XFEL Council (in 2005 prices)

Milestone validation

The progress of each contribution is monitored through specific milestones, the criteria of achievement being detailed explicitly in the corresponding IKC agreement. Each milestone is connected to a crediting allotment for the shareholder or to the payment of an invoice in the case of contracts with Russian institutes. The validation of milestones follows a specific procedure established in 2011.

Fifty-six milestones were completed and validated in 2014. Each involved a certificate signed by the work package leader and the Accelerator Consortium coordinator or the responsible scientific director and submitted for approval to the management board. Each certificate includes a link to the supporting documentation stored in a database.

The contributing shareholders receive official notification of the completion of each milestone.

In total, 216 of 610 milestones have been completed since the start of the project. All related documentation is stored in a specific IKC database for future traceability.

Fifty-six milestones were completed and validated in 2014. In total, 216 of 610 milestones have been completed since the start of the project.

Progress of IKCs

In 2014, the series production of IKC components for the accelerator complex progressed at full speed.

In particular, the following items were delivered:

- Superconducting cavities: 540 of 800 delivered
- Cryostats: 85 of 100 delivered
- Warm magnets: 715 of 715 delivered (completed)
- Cold magnets: 100 of 100 delivered (completed)

The continuous testing in the AMTF was a major effort in 2014. The testing of cavities in cold conditions by the Polish team of Henryk Niewodniczański Institute for Nuclear Physics (IFJ-PAN) reached its nominal rate (IKC PL05).

However, the manufacturing processes of two IKCs for the accelerator complex remained challenging: the production of power couplers and the assembly of accelerating modules. Countermeasures to mitigate schedule problems were implemented.

Photos of activities in 2014 in the collaborating institutes are shown in Figures 1–8.

In 2014, four IKCs were successfully completed:

■ **RU17, “Production and delivery of 125 warm magnets of type XQA” for Work Package 12, by Budker Institute of Nuclear Physics of SB RAS (BINP)**

A total of 125 quadrupole magnets custom-built for the European XFEL arrived in Hamburg and were characterized. The magnets will be used to focus the electron beam between the undulator segments—the magnetic structures in which the electron beam generates the X-rays.

Based on a design devised by Deutsches Elektronen-Synchrotron (DESY), the magnets were produced by BINP as a Russian IKC to the European XFEL. After production, they were shipped to Manne Siegbahn Laboratory at Stockholm University, where they were measured and fiducialized as part of a Swedish IKC to the facility.

■ **RU25, “Production and delivery of 22 coil sets for XQK warm magnets” for Work Package 12, by BINP**

Twenty-two coil sets for XQK warm magnets were manufactured by BINP. Different tests were applied to every coil for the final acceptance. In all the electrical tests—such as resistance measurement, insulation check, and leakage current test—the coil sets passed the specification. Moreover, hydraulic leak tests and flow measurements were carried out for the cooling water circuit. Stress conditions—such as 500 thermal cycles between 30°C and 80°C—were also applied to ensure reliability.

■ **RU11, “Production and delivery of warm magnets” for Work Package 12, by the Federal State Unitary Enterprise D.V. Efremov Research Institute of Electrophysical Apparatus (NIIIEFA)**

A total of 715 magnets were produced by NIIIEFA at an industrial scale, including a wide variety of dipoles, quadrupoles, and sextupoles (more than 25 types altogether). The production of these magnets required, in some cases, high-level knowledge and practice. In the case of XQF, for example, after stamping and staggering 1 mm thick steel sheets, which were covered on both sides with a 10 μm thick hot-melt adhesive material, each iron quadrant was baked in an oven to form a solid unit. Before four quadrants were assembled into a quadrupole magnet, the length of each quadrant had to be measured (Figure 3). If the measured value differed from the required dimension by more than 0.5 mm, at least one sheet had to be removed. The 90 XQF magnets will mainly be used in the collimator section but are also needed to focus the beam in the XTD1, XTD2, and XTD4 branches and into the dump.



Figure 1 Injector feed cap. Cryogenic transfer line connects with the Joule–Thomson box (IKC RU24 by BINP).

With the last magnet delivery, the Lambertson septums XBZ arrived at DESY. These special magnets, which deflect the electron beam, will substitute a normal septum magnet at three positions in the European XFEL beamlines. The XBZ magnets will reduce power losses of the beam by a factor of 10 as compared to a normal septum magnet, thereby saving running costs. A Lambertson septum was installed in the FLASH free-electron laser (FEL) facility at DESY to deflect the beam particles into the newly built FLASH2 beamline. Since mid-2014, the magnet has been successfully in operation. The work package applied not only economy of scale but also economy of scope by using the same knowledge for different kinds of magnets and different applications at an industrial scale.



Figure 2 Sextupole magnets. The control of chromatic effects is one of the main issues in the design of the optics in the collimation section. Therefore, introduction of chromaticity-correcting sextupoles becomes essential to improve overall system performance (IKC RU11/WP12 by NII-EFA).



Figure 3 Production of XQF quadrupole magnets in St Petersburg, Russia. The quadrant is measured before assembly with a precision of 0.5 mm (IKC RU11/WP12 by NII-EFA).



Figure 4 Tests carried out for the von Hamos spectrometer at the premises of JJ X-Ray in Lyngby, Denmark. The resolution ($0.2 \mu\text{m}$) and repeatability ($1 \mu\text{m}$) of motor movements were better than the specifications. The system was designed and produced by the industrial partner JJ X-Ray (IKC DK01 by DTU) for the Femtosecond X-Ray Experiments (FXE) instrument.



Figure 5 Stripline kicker (lower half, before assembly) of the transverse intra-bunch-train feedback. Design is by Paul Scherrer Institut in Villigen, Switzerland (based on CTF3/Daphne design by F. Marcellini et al., Istituto Nazionale di Fisica Nucleare (INFN) in Frascati, Italy), supported by DESY (wakefield simulations, M. Dohlus). The prototype was built by COMEB S.r.l. in Rome, Italy. The radio frequency (RF) test was successful. DESY uses a modified version for dump kickers (IKC CH03/WP16 by PSI).



Figure 6 Klystrons stored for tunnel installation after passing the acceptance test (IKC DE01 by DESY)



Figure 7 Setup for cavity characterization in the vertical acceptance test by a Polish team in the AMTF hall on the DESY campus (IKC PL05 by National Centre for Nuclear Research (NCBJ) in Otwock-Świerk, Poland).

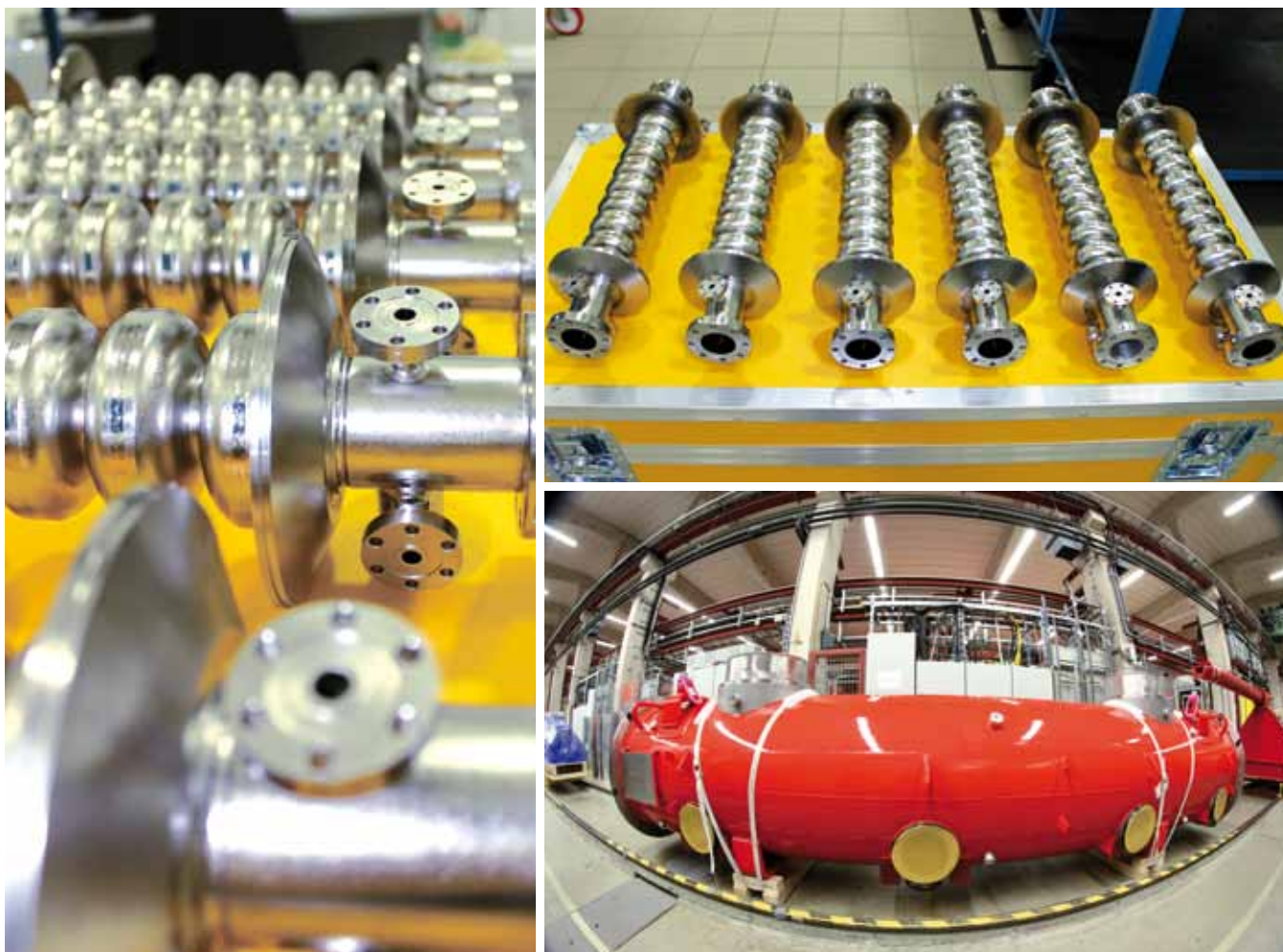

Figure 8 3.9 GHz system. The linearization of the RF-induced curvature in phase space is necessary to preserve the beam quality in the subsequent bunch compressor stages before entering the main linear accelerator. The RF curvature linearization is achieved by a third-harmonic section after the RF gun. The single module at 3.9 GHz consists of eight superconducting RF cavities (IKC IT03/WP46 by INFN – Sezione di Milano, Laboratorio Acceleratori e Superconduttività Applicata (LASA), Italy).

■ **ES02, “Superconducting magnets” for Work Package 11 by Centro de Investigaciones Energéticas, Medioambientales y Tecnológicas (CIEMAT)**

Each X-ray FEL accelerator module has one superferric quadrupole magnet including dipole correction coils for both planes. A beam position monitor is attached. The magnet design and prototype development was done by CIEMAT in Madrid, Spain, in 2006, and then repeated in collaboration with industry in 2010. Some improvements, both technical and financial, were necessary to prepare for series production. The contracts for series production (for 103 magnets) were awarded to Trinos Vacuum Projects S.L. in Paterna, Spain, and Aplicación Nuevas Tecnologías (Antec) S.A. in Portugalete, Spain (coil fabrication). A thorough quality assurance system was implemented, as the European pressure equipment

directives, among others, have to be observed. All individual magnets undergo a complete measurement (quadrupole and dipole fields) at the new DESY XFEL Cold Magnet Test Stand. All magnets successfully passed the tests.

In 2015, allocation of the remaining IKCs is expected to be completed, and a large number of milestones should be achieved in the ongoing IKCs. Various serial components of the accelerator complex should be delivered, and the commissioning of the injector system should be completed.

Outlook for 2015

In 2015, allocation of the remaining IKCs is expected to be completed. In addition, a large number of milestones should be achieved in the ongoing IKCs. Various serial components of the accelerator complex should be delivered, and the commissioning of the injector system should be completed. ■



Group member
Antonio Bonucci

ACCELERATOR CONSORTIUM

The linear accelerator complex of the European XFEL and its comprehensive infrastructure are being constructed by an international Accelerator Consortium of 17 European research institutes under the leadership of Deutsches Elektronen-Synchrotron (DESY). In 2014, series production continued for many components, numerous others were delivered, accelerator module assembly was ramped up, and installation started. By the end of the year, the European XFEL injector had essentially been set up, with the exception of the accelerator sections, and installation of the main cold sections of the linear accelerator had begun.

Manufacturing accelerator components to specification

The production of accelerator components for the European XFEL started in 2013 and continued in 2014.

The production of more than 700 beamline magnets of altogether 24 types by D.V. Efremov Research Institute of Electrophysical Apparatus (NIIEFA) in St. Petersburg, Russia, is basically finished, marking the end of a very successful collaboration.

A very large number of beam diagnostics elements are under production, available for installation, or have already been integrated in the injector beamline sections. Others are being installed in the accelerator modules: cold (that is, cryogenically cooled) beam position monitors (BPMs), warm (that is, not cryogenically cooled) BPMs, current transformers (toroids), dark-current monitors, scintillator-based screen stations, wire-scanners, and other diagnostics elements.

Altogether, 2.5 km of warm beamline vacuum sections will be installed. Approximately 95% of all commercial products (pumps, valves, and so on) for these sections were delivered. Installation of vacuum girders started, including beam diagnostics elements and smaller beam transport magnets. At the injector, more than 90% of vacuum girders were installed in 2014, with the individual sections still to be connected to each other. For the bunch compressor sections BC1 and BC2, girder installation started but is on hold until the delivery of the chicane vacuum systems from Budker Institute of Nuclear Physics (BINP) in Novosibirsk, Russia, which is scheduled for the first quarter of 2015. Tunnel installation will happen as soon as the cryogenic transfer line, which is located above the electron beamline, is finished. In the downstream undulator sections, installation is scheduled to begin in the first quarter of 2015. About half of the undulator chambers are ready for installation, and the vacuum chamber supports and intersection vacuum systems—both contributed by BINP—need to be delivered next.

All electron beamlines behind the different undulator sections end in the beam dumps where the electron beam is stopped in a cooled pyrolytic graphite cylinder. Production of the large main dumps is still ongoing. In 2014, major steps of the industrial production were finished. The dump pits are being prepared at DESY, where work in 2014 included testing of the dump vehicles, which are needed to safely exchange possibly activated beam dumps. A specially designed argon system to suppress ionization close to the beam dumps is being manufactured. Small beam dumps will be used at the end of the European XFEL injector and in the bunch compressor sections. Production of these small dumps was finished in 2014. The injector dump was finally installed.

The cold linear accelerator of the European XFEL consists of several sections with a total of 101 accelerator modules. The production rate was scheduled at one finished module per week. In 2014, this challenging goal was achieved. In September, stable delivery from Commissariat à l'Énergie Atomique et aux Énergies Alternatives (CEA) in Saclay, France, to DESY was established. By the end of 2014, almost a quarter of the total number of modules had been produced. Details are described in the section "Accelerator module production ramp-up" (starting on the next page).

To supply the European XFEL accelerator with radio frequency (RF) power, specially developed 10 MW multibeam klystrons are used. By the end of 2014, the two vendors had delivered 20 of 29 klystrons. The electrical power is supplied by 27 modulators, all of which have been produced. Only the last one is still to be installed in the new modulator hall (XHM). The RF power supply, one of the largest in-kind contributions from DESY, is complemented by waveguide systems. With the help of a Bulgarian team from Sofia contracted by DESY, the individually tailored waveguide distribution system for each module is being assembled right after the cold module test in the Accelerator Module Test Facility (AMTF) at DESY.

The cold linear accelerator of the European XFEL consists of several sections with a total of 101 accelerator modules. The production rate was scheduled at one finished module per week. In 2014, this challenging goal was achieved. By the end of 2014, almost a quarter of the total number of modules had been produced.

One full year of operation of the FLASH free-electron laser (FEL) facility at DESY with the prototype of the European XFEL low-level RF control (LLRF) system provided valuable input and experience for the startup of the European XFEL. Enhanced stability and performance was reached at FLASH. More work was done to analyse the impact of radiation on electronics (operation of field programmable gate array (FPGA) circuits)

and memory (hard disks, RAM). Both master oscillator (MO) and RF distribution were presented in final reviews. MO installation started. To prepare all LLRF electronic racks for tunnel installation, a rack assembly and test area was set up and commissioned close to the main accelerator tunnel entrance. Racks for the European XFEL injector and the first linear accelerator section (L1) were prepared and successfully tested. Many components for the RF stations in L2 and L3 are available. In 2014, many of the remaining calls for tender were awarded for components such as micro-telecommunications computing architecture (MTCA) crates, power supplies, central processing units (CPUs), down converters, and digitizers.

Almost all technical solutions were finalized in 2013. Since then, emphasis has been on addressing logistics issues. Constant component delivery rates have to be guaranteed, and slight variations in the rates have to be compensated. Deviations from specifications have to be either corrected or, in some cases, accepted within the bounds of possibility. Quick but reliable quality control is of the highest importance. Component integration became the most important issue of 2014.

Accelerator module production ramp-up

While the ramp-up of the industrial production of superconducting cavities was finished at the end of 2013, the assembly of the accelerator modules at Institut de Recherche sur les Lois Fondamentales de l'Univers (IRFU) of CEA in Saclay required a strong collaborative effort in 2014. All components needed to be delivered at a sufficient rate and quality so the assembly team could concentrate on the procedures and especially on the throughput of the different workstations.

The production of superconducting cavities became very stable and, by the end of 2014, approximately 500 of the 800 European XFEL cavities had been delivered. During tests at the AMTF at DESY (Figure 1) carried out by a team from Henryk Niewodniczański Institute of Nuclear Physics (IFJ-PAN) in Kraków, Poland, the performance of about two thirds of the cavities was found to be well above specifications, enabling many cavities to be used at an accelerating field of about 30 MV/m, which is more than 20% above the design value. Retreatment (mostly high-pressure water rinsing) of the other cavities also led to good results. In 2014, the need for cavity retreatment decreased, showing a clear improvement in production quality at the vendors.

High-power RF couplers turned out to be among the most challenging components needed for the accelerator modules, requiring care and excellent quality control in all production steps. To match the needs of the supply chain for the accelerator modules, a production rate of eight couplers per week was scheduled. In 2014, coupler production ramp-up was still an issue. For the first six months, fabrication and assembly mistakes caused problems. Since then, the request for constant quality

at a high production rate has dominated discussions between the in-kind contributor, Laboratoire de l'Accélérateur Linéaire (LAL) in Orsay, France, and the vendor. European XFEL and experts from DESY strongly supported the activities. As a consequence of the delayed ramp-up, only an insufficient buffer of couplers for module assembly was available during 2014. In total, 800 couplers are required for the European XFEL. In early 2014, European XFEL implemented the European XFEL Council decision to buy 150 couplers from a second vendor: eight pre-series couplers were fabricated by Beverly Microwave Division of Communications & Power Industries (CPI) in Massachusetts and RF-conditioned at SLAC National Accelerator Laboratory in Menlo Park, California. Regular delivery of the series couplers from the second vendor to LAL is scheduled for the end of the first quarter of 2015.



Figure 1 Accelerator modules in the Accelerator Module Test Facility (AMTF)

The superconducting quadrupole packages required for the assembly of the accelerator modules are built in a collaboration between Centro de Investigaciones Energéticas, Medioambientales y Tecnológicas (CIEMAT) in Madrid, Spain, IRFU, and DESY, with magnet tests performed by IFJ-PAN. By the end of 2014, magnet production was finished. All 101 magnets were delivered and successfully tested; many of them were integrated in the quadrupole packages ready for module integration at IRFU.

The cryostats were contracted, and production is supervised by DESY together with Istituto Nazionale di Fisica Nucleare (INFN) in Milano, Italy. Cold vacuum components are provided by BINP. The supply chain requires a perfectly timed delivery, and the schedule needs to include quality assurance and subsequent improvement or cleaning when necessary.

The assembly of the accelerator modules at CEA IRFU in Saclay, France, required a strong collaborative effort in 2014. All components needed to be delivered at a sufficient rate and quality so the assembly team could concentrate on the procedures and especially on the throughput of the different workstations.

IRFU has contracted a company to assemble all accelerator modules in its European XFEL infrastructure in Saclay. After the first module completely assembled by the industrial partner was finished, shipped to DESY, and successfully tested, a problem with unacceptably large pores in the welds of titanium tubes for the helium service pipe became apparent in late 2013. The welding problem was solved in 2014 by addressing two issues: pores in the longitudinal welds of the industrially produced service pipe required replacement of the tube, and welders were successfully trained to perform high-quality orbital welds during module assembly at IRFU. At DESY, a campaign was started to replace the service pipes.



Figure 2 View into the injector tunnel (XTIN) (November 2014)

At the beginning of 2014, the welding problem first halted and then delayed the assembly of further accelerator modules, but the definition of the repair procedure soon allowed the assembly schedule to be corrected. By the summer, the total assembly time had become shorter, and finally, the reorganization of the contracted assembly team brought the required success. The specified assembly and thus the delivery rate of one module per week was finally reached in mid-September.

All modules of the European XFEL are tested at the AMTF at DESY. Taking advantage of the increasing number of delivered accelerator modules, module testing was also ramped up in 2014. By the end of the year, the testing time had been shortened sufficiently to match an output rate of one module per week. Seventeen modules were tested in 2014.

The average usable accelerating gradient for the modules tested so far fulfils the European XFEL specifications. But besides some non-conformities that could be solved, a major problem was revealed in 2014. Many modules show a gradient degradation in typically one to three cavities. The cause of this degradation, which leads to an operation well below the high value measured in the vertical test, was still unknown at the end of 2014. Expert review is ongoing, and assembly procedures are followed with even more care. Fortunately, the gradient degradation can be compensated by a clever but sophisticated balancing of the RF power fed into the individual cavities.

Based on the resources assumed so far, the last module (XM100) will be assembled in late summer 2016. Therefore, an accelerated module assembly taking advantage of additional resources, which could reduce the delay by some months, is under discussion. IRFU has proposed shortening the assembly time in order to produce one additional module



Figure 3 Pouring of heavy concrete into the injector dump pit (May 2014)

per month. The component supply chain needs to support this plan, and the main emphasis needs to be put on RF power coupler availability. In a joint effort, European XFEL, DESY, IRFU, and LAL developed a strategy to realize and fund an assembly acceleration plan. For 2015, acceleration of the subsequent module testing at the AMTF and the module installation in the main linear accelerator tunnel is to be arranged.

Injector

Injector construction advanced well in 2014 (Figure 2). In principle, the injector components resemble the complete European XFEL accelerator: the photocathode electron source is followed by a superconducting linear accelerator consisting of a standard 1.3 GHz and a special 3.9 GHz module and, after these, by a warm (that is, operated at room temperature) electron beamline incorporating the laser heater system and advanced beam diagnostics, before the electrons are injected into the main linear accelerator or discarded in the electron dump.

The injector beam dump has a construction similar to the dumps beyond the end of the linear accelerator. It can absorb up to 12 kW of beam power, thus enabling the operation of the injector with full beam current. The dump core can be exchanged. It is enclosed in a stainless-steel housing, which in turn is embedded in a heavy-concrete shielding. Because of the tight alignment tolerances of the electron beamline compared to the building construction tolerances, the heavy-concrete shielding had to be poured in situ after final alignment of the dump in the dump pit (Figure 3). Installation of the injector dump itself followed a few months after the concrete pouring (Figure 4).



Figure 4 Installation of the injector dump (July 2014)



Figure 5 Installation of vacuum components on girders in the cleanroom (August 2014)



Figure 6 Installation of the cryo-valve boxes for the injector and linear accelerator cryogenic supply (November 2014)

The warm electron beamline is pre-assembled on reinforced concrete girders. All vacuum installations have to be done in cleanroom conditions to avoid later contamination of nearby superconducting modules. After mechanical pre-alignment of the magnets on the girders, the assembly of the vacuum parts and the integration of all subcomponents, such as diagnostics devices, therefore take place in a dedicated DESY cleanroom (Figure 5). All components are aligned with respect to each other by means of a specially designed fixation system that avoids the need for mechanical alignment later on. The achieved precision is in the range of 300 μm peak-to-peak and well within specifications. All six completed girders are now installed in the injector tunnel and await final global alignment, vacuum connection, and cabling.



Figure 7 Inserting a vertical cryogenic transfer line into the media shaft in the entrance shaft XSE (May 2014)

A special diagnostic tool is the transverse deflecting system (TDS), an S-band transverse mode deflector contributed by Institute for Nuclear Research (INR) in Troitsk, Russia. TDS systems will be installed in the injector and after the bunch compressors BC1 and BC2, enabling the diagnosis of beam properties along the bunch. The injector system should be the first to go into operation in summer 2015. The deflector structure itself was successfully manufactured, tuned, cleaned, and, after final vacuum quality control, installed on Girder 2. The waveguide components that are directly attached to the deflector structure have to fulfil the same stringent quality requirements with respect to particle cleanliness and leak rate. This is a challenge for manufacturers with no previous experience with such high demands.

One of the main purposes of the TDS will be the verification of the successful commissioning of the laser heater. The laser heater overlaps the electric field of an infrared laser with the electron beam in an undulator that is about 80 cm long. By this means, energy is transferred from the laser beam to the electron beam, and the uncorrelated energy spread of the electron beam is increased. Most of the laser heater components (undulator, vacuum chamber, laser beamline, and diagnostics) were supplied by Uppsala University in 2014 and partly installed.

The cryogenic installation for the injector linear accelerator was completed with the installation of the accelerator feed and end cap and of the transfer lines that lead from the seventh underground floor up to the cryo-valve box located on the fourth underground floor of the injector building (Figure 6). The components were manufactured at BINP. The transfer lines are up to 12 m long, and their installation in the media shafts and tunnels is a challenge for the transport experts and an event for the onlookers (Figures 7 and 8).

The cryogenic installation for the injector linear accelerator was completed with the installation of the accelerator feed and end cap and of the transfer lines that lead from the seventh underground floor up to the cryo-valve box located on the fourth underground floor of the injector building.

The finalization of the injector linear accelerator awaits the completion of the 3.9 GHz superconducting module. This module, which hosts eight 9-cell cavities and allows the manipulation of the longitudinal phase space, is crucial for the operation of the European XFEL. Its production is a joint effort of INFN in Milano and DESY. The cavities were produced in 2014, and all of them successfully passed the vertical tests at INFN. The module cold mass and all auxiliaries



Figure 8 Another vertical cryogenic transfer line (February 2014)



Figure 9 Working on the injector laser (June 2014)

were delivered. After a final test of some fully equipped cavities at the AMTF, the module will be assembled at DESY.

The photocathode electron source was installed in 2013. In addition, the about 2 m long, densely packed diagnostics beamline between the source and the end cap of the first superconducting accelerator module was mounted in 2014. Again, a girder system was used, with pre-assembly of all components in a cleanroom. This beamline section will allow beam size, position, and charge to be measured even before the injector linear accelerator is completed.

The RF gun itself was operated in between installation periods, allowing the operation crew to gain valuable experience with all involved subsystems. The main challenge continues to be the long-term, stable operation of the RF setup. The ultimate beam quality that is required for the European XFEL can be obtained only with a large accelerating gradient of about 60 MV/m in the gun structure, which has a length of 1.5 cells. This requires a peak power of about 6.5 MW over a time of about 1 ms. Both the peak power and the average power put stress on the waveguide subcomponents, in particular at the ceramic window that separates the waveguide system from the gun body vacuum. These issues emerge only after longer operation periods, which makes it difficult to specify design improvements. An intense R&D programme was set up at DESY to tackle this problem. At the PITZ photoinjector test facility at DESY in Zeuthen, a solution in which the RF power is distributed over two windows is being experimentally tested, while in Hamburg, tests continue in the European XFEL injector and on a special window test stand. A further concern is the area around the photocathode insert at the back wall of the gun body. The huge fields lead to arcing and material erosion in this area. Several design improvements have been pursued and are giving encouraging results, although the final proof of long-term reliability is still missing.

The injector laser was set up and put into operation during the last quarter of 2014. The laser will illuminate the photocathode with ultraviolet light and will also serve as source for the laser heater. The laser was developed by MBI in a long-standing cooperation with DESY. It is based on Yb:YAG active laser material, which allows for short pulse widths.

The injector laser was set up and put into operation during the last quarter of 2014 (Figure 9). The laser will illuminate the photocathode with ultraviolet light and will also serve as source for the laser heater. The laser was developed by Max Born Institute (MBI) in Berlin, Germany, in a long-standing cooperation with DESY. It is based on Yb:YAG active laser material, which allows for short pulse widths. The integration, future operation, and development of the laser system will be performed by DESY's recently established laser group.



Figure 10 Installed accelerator modules in the L1 section

Installation and infrastructure

The infrastructure and installation planning is nearing completion. With the southern beam fan, the last underground section got its planning approval in 2014. The corresponding tendering processes are under way. The installation work in the supply buildings is advancing well after a delayed start.

In the SASE1 section, the infrastructure is ready, the undulator and beamline supports are installed, and a large fraction of the racks are in place. After the final enclosures and the supports for the beamlines leading towards and away from the undulators are finished, the installation of the vacuum chambers and the roll-in of the undulators can begin. This is expected in the second quarter of 2015.

In the SASE1 section, the infrastructure is ready, the undulator and beamline supports are installed, and a large fraction of the racks are in place. After the final enclosures and the supports for the beamlines leading towards and away from the undulators are finished, the installation of the vacuum chambers and the roll-in of the undulators can begin.

In the linear accelerator tunnel (XTL), the modules for the first accelerator section (L1) are installed and aligned (Figure 10). Welding the connections between the modules and connecting the beam vacuum are expected in early February 2015. Installation of the corresponding RF station will follow immediately so RF commissioning with warm modules can start in the first quarter of 2015. Meanwhile, installation of the modules for the subsequent accelerator sections continues.

The main cryogenic transfer line is progressing well. The cold compressor box was preliminarily commissioned in the refrigerator hall and subsequently transferred to its final position in the injector building. The cryogenic transfer line for the injector was completed and tested. Parts for the main accelerator cryogenic supply system were delivered and installed; completion is expected in the second quarter of 2015.

Section reviews are continuing for the underground tunnels and beamline sections to conclude the detailed planning. All warm magnets were delivered and tested. The girders for the bunch compressor sections are available and are being equipped with the beamline elements. The design for the beamline suspensions in the downstream end of XTL is complete; tendering is under way. ■

05

PHOTON BEAM SYSTEMS

Preparation for commissioning of the first beamline was the main focus of the photon beam systems groups in 2014. Additionally, a simulations software package was further developed and a new theoretical physics group was formed.

Mounting of an X-ray filter foil

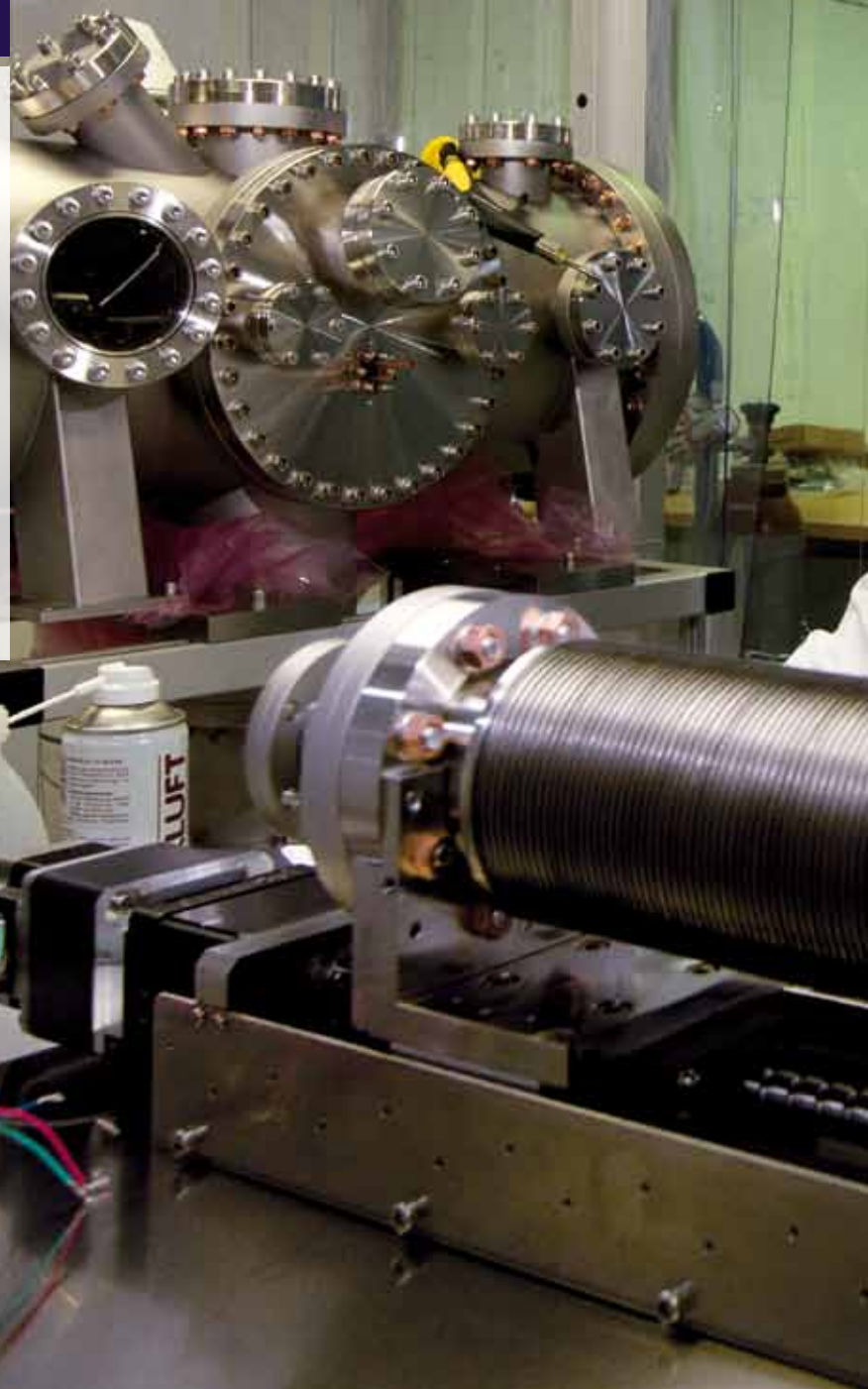



UNDULATOR SYSTEMS

Undulator systems are of central importance for the European XFEL. Inside these periodic magnetic structures, the electron beam interacts with the magnetic field, thereby generating ultrabright pulses of X-ray radiation. Three undulator systems are under construction for the European XFEL. SASE1 and SASE2, which will generate hard X-ray radiation, will be more than 200 m long. Seventy undulator segments with a period length of 40 mm are being produced for those hard X-ray systems. The soft X-ray undulator system, SASE3, will be about 120 m long and will contain 21 segments with a period length of 68 mm. The Undulator Systems group is responsible for producing, installing, and commissioning these systems.

Summary of 2014

In 2014, the Undulator Systems group focused on the serial production of the required hardware, which had started in 2012 and 2013. This hardware includes undulator segments, phase shifters, quadrupole movers, and intersection control racks. The group also organized and coordinated the extensive installation work in the tunnel XTD2, which will house SASE1, and the tunnel XTD4, in which SASE3 will be located (see Chapter 3, “Civil Construction”, Figure 2).

As scheduled, the last 4 of the 91 support structures were delivered to European XFEL in June 2014. In July, the last magnetic structures were delivered and combined with the support structures.

Hardware production

In 2014, serial production of the hardware continued. Ninety-one undulator cells for the European XFEL are being equipped, each consisting of a 5 m long undulator segment, a phase shifter, a quadrupole mover, and an intersection control rack. The rack is needed to control the phase shifter and the quadrupole mover. To minimize the risk of malfunction after installation in the tunnels, the strict quality management introduced in 2013 was further improved and enforced. For all components, factory acceptance tests (FATs) are performed at the supplier, followed by site acceptance tests (SATs) done at European XFEL. SATs validate full compliance with European XFEL specifications as well as full functionality under operating conditions. For documentation, each component is identified by a serial number. All the results of FATs and SATs are stored in the Engineering Data Management System (EDMS) provided by Deutsches Elektronen-Synchrotron (DESY), where they can easily be retrieved for later use.

Undulator segments

Serial production of the undulator segments started at the end of 2012 in European industry. As scheduled, the last 4 of the 91 support structures were delivered to European XFEL in June 2014. In July, the last magnetic structures were delivered and combined with the support structures. The completion of the mechanical production was celebrated on 17 July 2014. However, magnetic measurements and tuning of undulator segments will continue at European XFEL until spring 2015.

By the end of 2014, all 91 undulator segments were mechanically manufactured and delivered to European XFEL. Out of these 91 segments, 83 were magnetically measured and tuned.

Phase shifters

The phase shifters are being produced in equal shares by three suppliers in Germany, Italy, and China. In the course of 2014, all suppliers finished mechanical hardware production and concentrated on magnetic tuning to achieve the demanding European XFEL specifications for the gap dependence of the first field integrals. The feasibility of these specifications had been demonstrated previously, as described in “Undulator Systems” in last year’s *Annual Report* [1]. Tuning was, however, quite time-consuming. To speed it up, a fast systematic shimming technique was developed, which allows the compensation of any observed gap dependence of the first field integrals by applying a suitable set of shims.

For the SATs at European XFEL, a dedicated moving wire stand was set up. The phase integrals are validated by temporarily using one of the three magnetic benches.

By the end of 2014, about 60 phase shifters were supplied to European XFEL; 50 of them passed the SATs.

Quadrupole movers and intersection control racks

The quadrupole movers and intersection control racks are a Spanish in-kind contribution to the facility by Centro de Investigaciones Energéticas, Medioambientales y Tecnológicas (CIEMAT) in Madrid. Serial production started in early 2013 under the full responsibility of CIEMAT. After delivery to European XFEL, SATs are done by CIEMAT, providing 100% quality control. For all quadrupole movers and intersection control racks, operability and compliance with specifications are being tested. By the end of 2014, 84 quadrupole movers passed FATs, and 80 were accepted by SATs. All 91 intersection control racks were accepted by SATs.

An overview of the production status of the undulator segments, phase shifters, quadrupole movers, and intersection control racks is given in Table 1.

	Total needed	FAT passed	SAT passed
Undulator segments	91	91	83*
Phase shifters	91	70	56
Quadrupole movers	91	84	80
Intersection control racks	91	91	91

* Includes magnetic measurement and tuning done by European XFEL

Table 1 Production status of undulator segments, phase shifters, quadrupole movers, and intersection control racks in December 2014



Figure 1 Status of SASE1 installation in the XTD2 tunnel in November 2014. Installed in the tunnel are undulator control racks (A), guide rails (B), enclosure and gasket seals (C), support frame (D), intersection control racks (E), vacuum posts (F), floor mounts (G), and concrete pillars (H).

Installation in the tunnels

Installation of the tunnel infrastructure—support frames and piping for cooling water—in XTD2 started in January 2014. After completion of XTD2 in March, rough work resulting in any kind of dirt and dust—such as drilling, cutting, concrete work, concrete casting, and so on—must be finished before the first components of the undulator system can be installed.

Work done by the end of 2014 includes:

- Installation of concrete pillars, floor mounts, and vacuum support posts
- Installation of undulator control racks and intersection control racks in the support frames underneath the tunnel ceiling
- Installation of the first part of the undulator air conditioning system, consisting of guide rails for the enclosure and the sealed connections to the tunnel ceiling

Figure 1 shows the status of the SASE1 system in the XTD2 tunnel in November 2014. The installation of SASE3 in the XTD4 tunnel is similar to XTD2 but started about five to six months later.

Outlook for 2015

In 2015, all three undulator systems will progress towards completion. On the hardware side, the production and validation of all components will be completed by April.

The focus will then be more and more on the installation in the tunnels:

■ **XTD2/SASE1**

Installation will continue. In March, the tunnel will be cleaned so that the installation of sensitive items—such as quadrupole movers, phase shifters, and vacuum system—can start. The first undulator segments will be moved into the tunnel in August. The SASE1 undulator system will be finished by the end of 2015.

■ **XTD4/SASE3**

The installation schedule follows the scheme of SASE1 with a time difference of about five months. The scheduled completion date is April 2016.

■ **XTD1/SASE2**

Installation of SASE2 will follow SASE1 with a time difference of about one year. By May 2015, the technical infrastructure will be in place and the installation of the undulator system will begin. The scheduled completion date is September 2016. ■

References

[1] **European XFEL Annual Report 2013**

M. Altarelli et al.
XFEL.EU AR-2013
doi:10.3204/XFEL.EU/AR-2013



Group members

(left to right) Suren Abeghyan, Martin Knoll, Uwe Englisch, Marc Viehweger, Bora Ketenoglu (guest), Frederik Wolff-Fabris, Majid Bagha-Shanjani, Georg Deron, Karl-Heinz Berndgen, Mikhail Yakopov, Joachim Pflüger (group leader), Yuhui Li, Suren Karabekyan, Andreas Beckmann (until April 2014, not shown), Pitt Biermordt (student, until August 2014, not shown), and Chao Li (guest, not shown)

SIMULATION OF PHOTON FIELDS

The Simulation of Photon Fields (SPF) group studies possible developments beyond the baseline concept of the European XFEL to improve the performance of the facility. The group is also developing a software platform to simulate spontaneous radiation (SR) and X-ray free-electron laser (FEL) radiation. This platform will serve as a tool for concept development and for the design and optimization of synchrotron radiation and FEL facilities.

Challenges, projects, and collaborations

In 2014, SPF group members Ilya Agapov and Gianluca Geloni continued previous collaborations with members of external institutions: Guangyao Feng, Vitali Kocharyan, Evgeni Saldin, Svitozar Serkez, and Igor Zagorodnov at Deutsches Elektronen-Synchrotron (DESY); Kartik Ayyer and Oleksandr Yefanov at Center for Free-Electron Laser Science (CFEL) in Hamburg, Germany; Michael Gensch at Helmholtz-Zentrum Dresden-Rossendorf (HZDR), Germany, and the THz photodiagnostic collaboration (THODIAC); and Nikolay Smolyakov and Sergey Tomin at the National Research Centre “Kurchatov Institute” (NRC KI) synchrotron in Moscow, Russia.

The subjects of these collaborations included the further development of the simulation software package OCELOT (previously known as “xframework”), a study on the application of post-saturation tapering to improve the European XFEL performance, basic theoretical research related to the definition and calculation of SR source brightness, the application of self-seeding and tapering to the imaging of single biomolecules, the submission of a proposal aiming at the further development of OCELOT and of FEL and SR studies, and theoretical support of the characterization of high-repetition-rate, high-power THz sources.

The software package OCELOT, which is at an advanced stage of development, is at the core of the group’s simulation work.

Software development

The SPF group leads an international collaboration that is developing the open-source multiphysics software package OCELOT [1], with application focus on synchrotron radiation, beam dynamics, and FEL radiation production and transport. This software, which is at an advanced stage of development, is at the core of the group’s simulation work. It is also used at facilities other than the European XFEL.

Post-saturation tapering studies

Within the collaboration with DESY, SPF group members Agapov and Geloni continued to study the performance of post-saturation tapering, a field of research they started to work on in 2013. The use of OCELOT made it easier to calculate optimized radiation parameters over the whole wavelength range of the European XFEL. Based on nominal parameters for the electron beam, the study confirmed that undulator tapering allows up to a tenfold increase in peak power and photon spectral density to be achieved compared to the conventional self-amplified spontaneous emission (SASE) regime.

Developing a theory of brightness

“Brightness” is a figure of merit used to describe the overall performance of an X-ray source. DESY collaborators, together with SPF group member Geloni, focused on the definition of brightness as the maximum of the Wigner distribution (WD) of synchrotron radiation. They studied the case of undulators, wigglers, and bending magnets, finding significant qualitative and quantitative disagreement between exact calculations and the approximations currently used in the literature. They extended the WD formalism to a satisfactory theory for the brightness of a bending magnet [2] and, in a separate work, of wigglers. Figure 1 shows an example of the intensity distribution at a virtual wiggler source, which was simulated for the study of brightness.

Bio-imaging applications

DESY and CFEL collaborators, together with SPF group member Geloni, continued to develop a configuration proposed in 2013 that combines hard X-ray self-seeding (HXRSS), undulator tapering, and an emittance spoiler method to increase the X-ray FEL output peak power and shorten the pulse duration. This configuration is for applications pertaining to the imaging of single protein molecules. Issues concerning the orientation of the 3D pattern in reciprocal space were solved, and attention is currently focused on phase retrieval.

Proposals and workshops

Together with Claudio Pellegrini of SLAC National Accelerator Laboratory and University of California at Los Angeles (UCLA), SPF group member Geloni organized an international workshop on advanced FEL techniques, with special focus on self-seeding. The workshop, which took place in Hamburg in May 2014, allowed participants to identify critical technical issues of common interest and facilitated the development of new ideas

at the frontier of FEL techniques. Geloni also helped to coordinate the writing of a proposal for HXRSS implementation at the European XFEL. The proposal, jointly funded the German Federal Ministry of Education and Research (BMBF) and the Ministry of Education and Science of the Russian Federation, was submitted in the framework of the Ioffe-Röntgen-Institute (IRI), a partnership between Germany and the Russian Federation. It was approved at the end of 2014.

Finally, SPF group members Agapov and Geloni, together with Russian colleagues, submitted a proposal, called EDYN_EMRAD, to support further development of the OCELOT software package and its application to SR and FEL facilities. This proposal, jointly funded by BMBF and the Russian science ministry, was also submitted in the framework of IRI and approved at the end of the year.

A proposal to support further development of the OCELOT software package and its application to SR and FEL facilities was also submitted in the framework of Ioffe-Röntgen-Institute and approved at the end of the year.

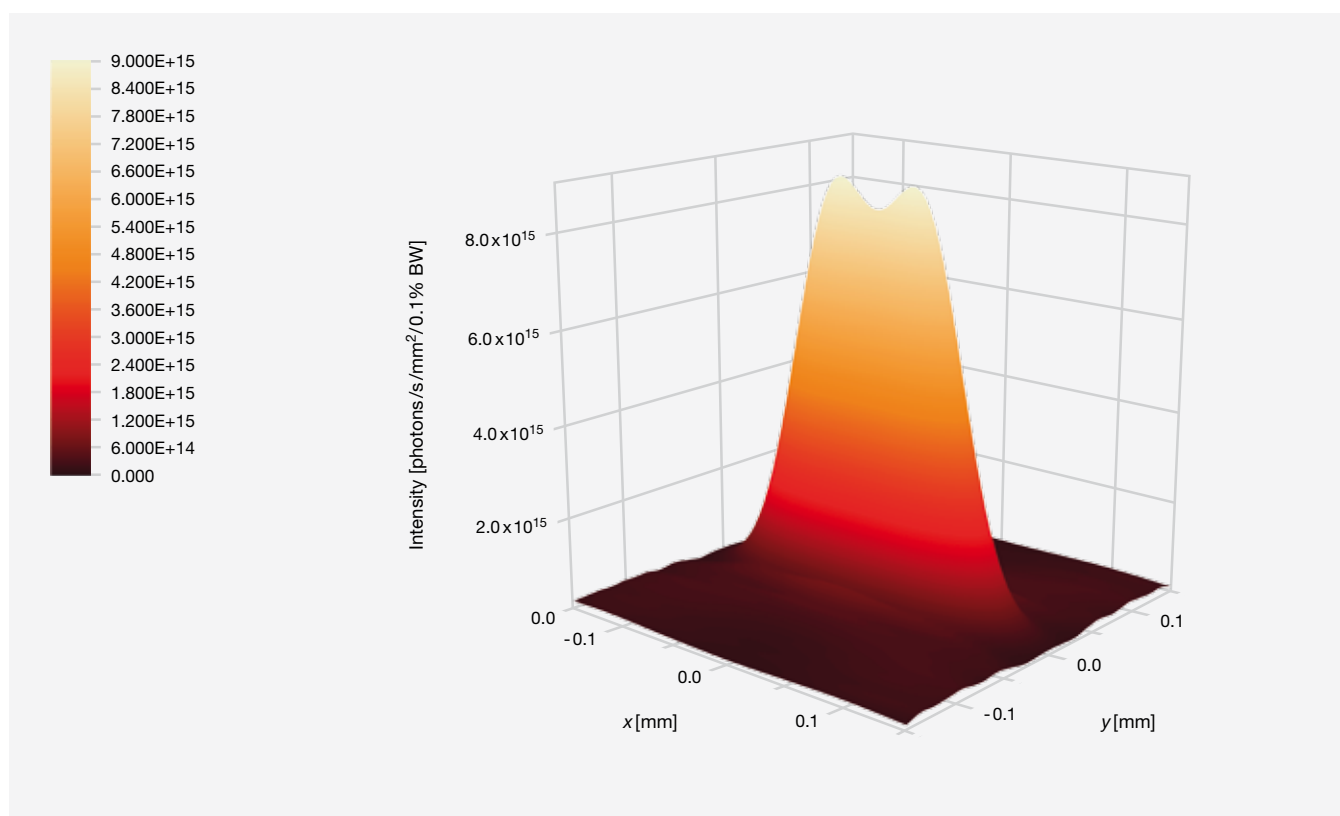

Figure 1 Ideal wiggler. Example of intensity distribution at the virtual source placed in the middle of the wiggler, considering an electron beam with finite emittance. The image was obtained by simulating a perfect lens immediately behind a centred rectangular aperture.

Outlook for 2015

The SPF group members will continue their research activities in the areas outlined above within old and new collaborations. The group will soon hire new personnel in the framework of the IRI project to further develop the OCELOT software package. The group members will continue their efforts toward start-to-end simulations of single-biomolecular imaging and plan to continue their contribution to the development of the HXRSS setup at the European XFEL. Finally, they will take part in a study of the potential of HXRSS, coupled with tapering, for inelastic X-ray scattering at the European XFEL and will continue to support the development and characterization of high-yield, high-repetition-rate THz sources. ■

References

[1] OCELOT: a software framework for light source and FEL studies

I. Agapov, G. Geloni, S. Tomin, I. Zagorodnov
Nuclear Inst. and Methods in Physics Research A **768**, 151–156 (2014)
doi:10.1016/j.nima.2014.09.057

[2] Brightness of Synchrotron radiation from Undulators and Bending Magnets

G. Geloni, V. Kocharyan, E. Saldin
J. Synchrotron Rad. **22**, 288–316 (2015)
DESY 14-129
doi:10.1107/S1600577514026071

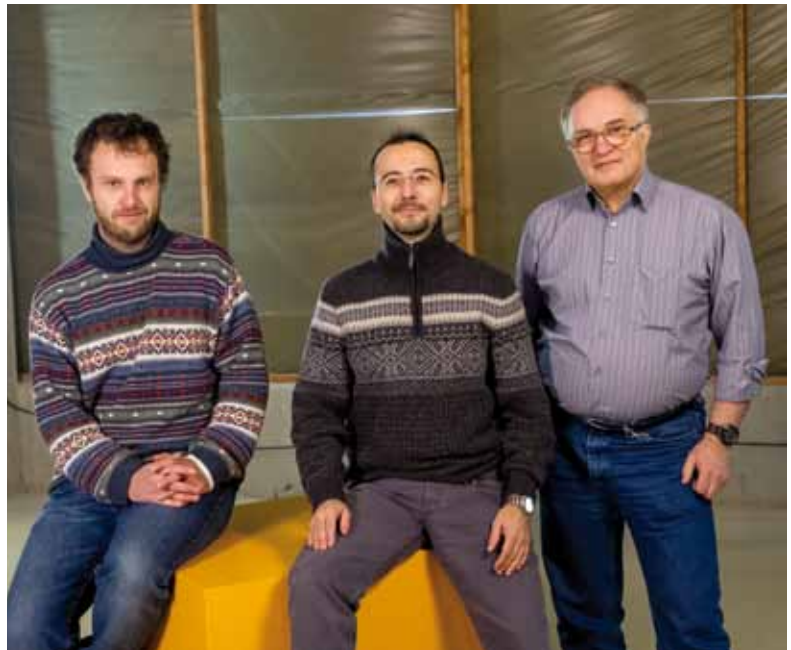

Group members

(left to right) Ilya Agapov, Gianluca Geloni (group leader), Nikolay Smolyakov (guest), and Sergey Tomin (guest, not shown)

THEORY

The task of the new Theory group is to generate ideas for novel applications and to design efficient methods in order to extract and analyse information from data acquired at the European XFEL. The group's research involves theory development and simulations ranging from the electronic structure of complex solids to the nanoscale structure of matter. Close cooperation with the instrument groups ensures that the cutting-edge experiments at the European XFEL will be supported by a solid theoretical basis.

Theory group establishment and first steps

The Theory group was established in the fall of 2014. It operates under the scientific supervision of Alexander Lichtenstein from the Institute of Theoretical Physics at the University of Hamburg, who is an expert in theoretical condensed-matter and many-body physics. European XFEL appointed two scientists, Evgeny Gorelov and Ruslan Kurta, in the fields of electronic structure theory and structure of matter.

The group was established in the fall of 2014. It operates under the scientific supervision of Alexander Lichtenstein from the University of Hamburg, who is an expert in theoretical condensed-matter and many-body physics.

In 2014, the group defined primary targets of the theoretical effort and established collaborations with in-house and external groups: Gorelov started collaborating with Andreas Scherz and Manuel Izquierdo from the Spectroscopy and Coherent Scattering (SCS) instrument group. This collaboration aims to establish the theoretical background for novel experimental studies of the electronic structure of strongly correlated materials. Another collaboration was started with Gianluca Geloni and Ilya Agapov from the Simulation of Photon Fields group. Its goal is to understand the interaction of correlated materials with X-ray free-electron laser (FEL) radiation, especially temporal aspects of the interaction. Kurta began collaborating with Adrian Mancuso from the Single Particles, Clusters, and Biomolecules and Serial Femtosecond Crystallography (SPB/SFX) group as well as with Haydyn Mertens and Daniel Franke from the European Molecular Biology Laboratory (EMBL) in Hamburg. The aim of the collaboration is to develop a novel method for single-particle structure determination from solution scattering using the unique X-ray FEL beam properties. Kurta also collaborates with Ivan Vartanyants and Ivan Zaluzhnyy from Deutsches Elektronen-Synchrotron (DESY) in Hamburg and Boris Ostrovskii from the Institute of Crystallography in Moscow on the development and application of advanced X-ray scattering approaches. The Theory group obtained

valuable support from scientists visiting European XFEL, namely Nikolay Kabachnik (Moscow State University, Russia), Alexander Joura (Max Planck Institute for the Structure and Dynamics of Matter, Hamburg, Germany), and Sergey Isakov (Ural Federal University, Ekaterinburg, Russia), who maintain a strong and fruitful collaboration with the Small Quantum Systems (SQS) group and the SCS group on time-dependent phenomena in strong electromagnetic fields. The activities set up in 2014 are expected to continue and expand in 2015.

The Theory group obtained valuable support from scientists visiting European XFEL who maintain a strong and fruitful collaboration with the SQS and SCS instrument groups.

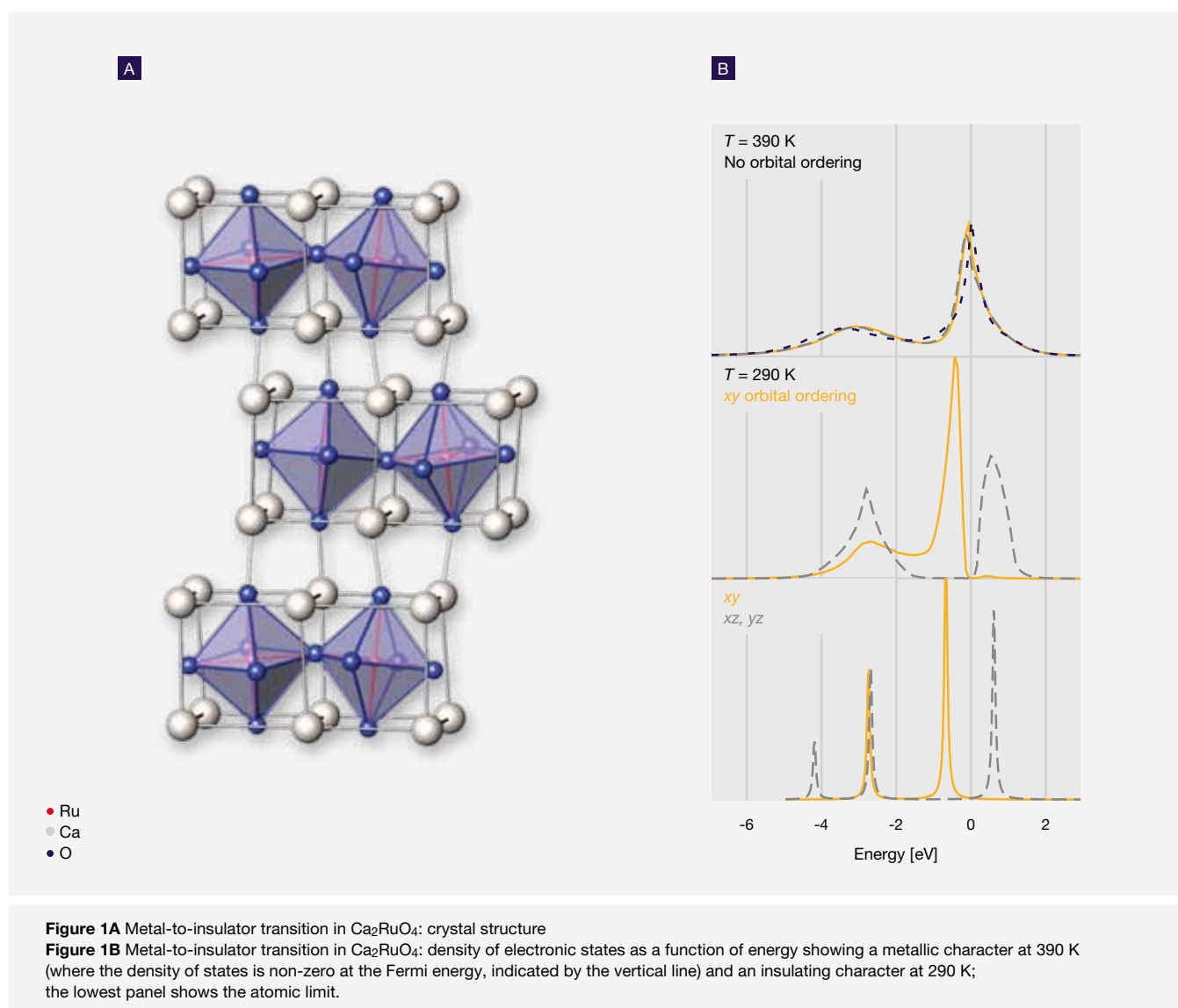

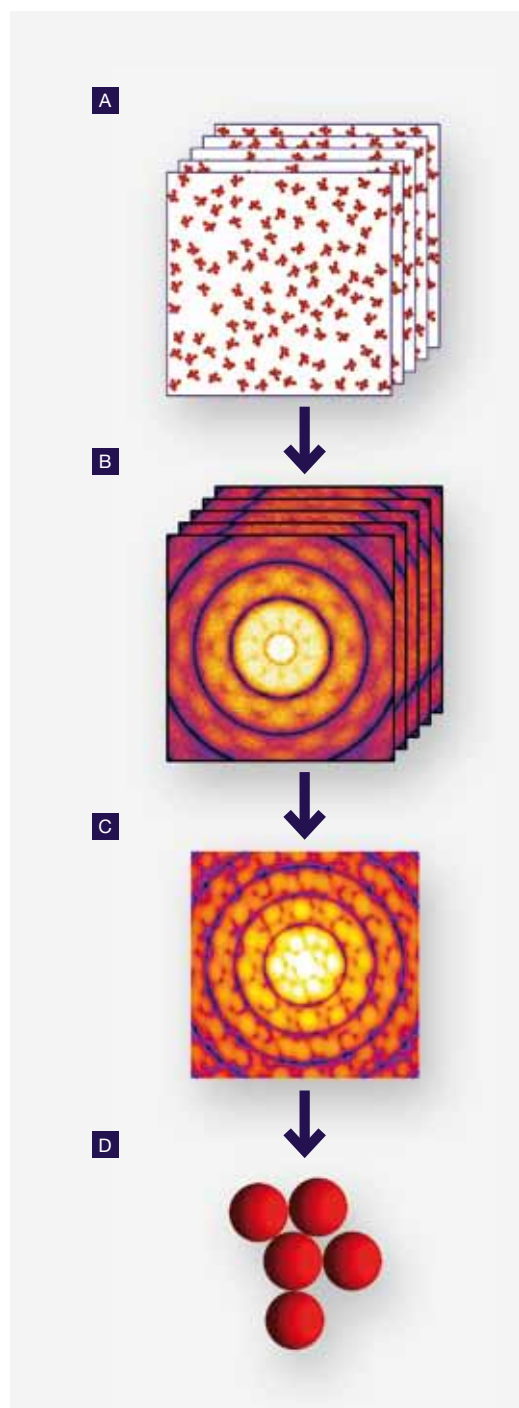

Figure 2 Three-step realization of the concept “scatter from many, determine single” [2]. A large number of realizations of a disordered system (A) composed of many identical particles are used to collect a set of diffraction patterns (B). XCCA is applied to this X-ray data set to recover a diffraction pattern (C) corresponding to a single particle. The structure of the single particle (D) is determined by applying phase retrieval algorithms to the recovered diffraction pattern (C).

Electronic structure of strongly correlated materials

Systems with strong electronic correlations are one of the most fascinating problems in modern solid-state physics. Strongly correlated materials—in which the description of the wavefunction of all electrons as a product of one-electron wavefunctions is manifestly an inadequate approximation—exhibit a variety of intriguing properties and phenomena, which are very sensitive to changes in certain control parameters (for example, temperature, electric and magnetic fields, and pressure). Gorelov developed an accurate many-body scheme for the electronic structure of correlated materials starting from first-principle density functional theory. One example of such an investigation, which is particularly interesting for practical applications, is the Mott metal-to-insulator transition (Figure 1). Ph.D. student Michael Karolak from the University of Hamburg used realistic density functional theory plus dynamical mean-field theory (DFT+DMFT) methods to interpret the experiments of Manuel Izquierdo and colleagues on laser-induced charge-disproportionated metallic states in LaCoO_3 [1].

Non-equilibrium correlated systems in strong electric fields

One of the main theoretical challenges of X-ray FELs is related to the time-dependent behaviour of correlated systems in strong electromagnetic fields. Joura developed a microscopic approach to non-equilibrium many-body dynamics and studied the behaviour of the single-band Hubbard model—a mathematically simplified model of correlated electron systems—in the presence of a large time-dependent electric field. The Theory group found that the strong electric field pulse can drive the system to a steady non-equilibrium state, which does not evolve into a thermal state.

Single-particle structure from solution scattering

One of the major goals of the X-ray FEL community is to image an individual particle (for example, a biological molecule) at near-atomic resolution. While the implementation of single-particle coherent diffractive imaging for non-crystalline samples remains technically challenging, the concept “scatter from many, determine single” offers an alternative path to single-particle structure determination (Figure 2). Within the established collaboration with Mancuso, Mertens, and Franke, the Theory group is developing a method to recover the structure of a single particle using X-ray FEL data measured from a disordered ensemble of such particles. A combination of small-angle X-ray scattering (SAXS), X-ray cross-correlation analysis (XCCA), and coherent diffractive imaging (CDI) should constitute the core of such an approach.

Structure and dynamics of non-crystalline materials

While X-ray studies of crystalline materials rely on a solid theoretical and experimental foundation, investigation of the structure of non-crystalline materials remains a challenge both in theory and experimental realization. The ultrashort intense coherent X-ray pulses produced by the European XFEL offer unique experimental possibilities to study the structural features of non-crystalline systems. The Theory group focuses on developing novel methods for nanoscale studies of the structure and dynamics of disordered and partially ordered systems using FEL radiation. A theoretical basis of such methods will be supported by Monte Carlo and molecular-dynamics simulations. Novel XCCA is one of the key elements of this project, which is subject to continuous development and extension. Recently, Kurta, in collaboration with the group of Vartanyants and Ostrovskii, successfully applied XCCA to study structural features of liquid crystals and polymer blends using synchrotron radiation. Further extension of XCCA should facilitate the recovery of the fine-structure information about a disordered system encoded in the scattered X-ray FEL pulses. ■

References

[1] Laser-induced charge-disproportionated metallic state in LaCoO_3

M. Izquierdo, M. Karolak, C. Trabant, K. Holldack, A. Föhlisch, K. Kummer, D. Prabhakaran, A. T. Boothroyd, M. Spiwek, A. Belozarov, A. Poteryaev, A. Lichtenstein, S. L. Molodtsov
 Phys. Rev. B **90**, 235128 (2014)
 doi: 10.1103/PhysRevB.90.235128

[2] X-ray cross-correlation analysis of disordered ensembles of particles: potentials and limitations

R. P. Kurta, M. Altarelli, I. A. Vartanyants
 Adv. Cond. Matter. Phys. **2013**, 959835, (2013)
 doi: 10.1155/2013/959835

Group members

(left to right) Ruslan Kurta, Alexander Lichtenstein (group leader), Evgeny Gorelov, Alexander Joura (guest, not shown), Nikolay Kabachnik (guest, not shown), Michael Karolak (student, not shown), Sergey Iskakov (guest, not shown), and Maria Valentyuk (student, not shown)

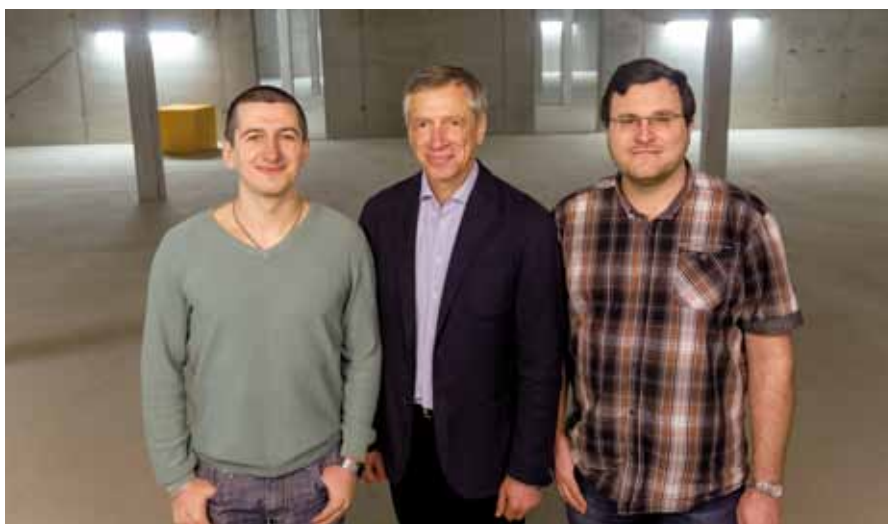

X-RAY OPTICS AND BEAM TRANSPORT

The X-Ray Optics and Beam Transport group develops and installs X-ray optical and beam transport components between the undulators and the experiment hall. These devices are located in the tunnels and shaft buildings of the facility and include offset and distribution mirrors, monochromators for hard and soft X-rays, shutters, slits, attenuators, collimators, and the vacuum system. To minimize contamination of and damage to the sensitive X-ray optical surfaces, high standards for vacuum cleanliness and residual dust particle concentration are required.

Progress made in 2014

A large number of vacuum components needed for the beam transport system arrived in 2014. Front ends, solid attenuators, and spontaneous-radiation apertures were received as complete units from external companies, while the gas attenuator, differential pumping sections, beam pipes, and supports are being assembled and technically commissioned in house.

Important milestones in 2014 were the beginning of installation work in the underground tunnels and the start of final polishing of the first mirrors. Major progress has been made in completing the detailed design of the X-ray beamlines and components and in building up metrology capabilities.

Important milestones in 2014 were the beginning of installation work in the underground tunnels and the start of final polishing of the first mirrors. Major progress has been made in completing the detailed design of the X-ray beamlines and components and in building up metrology capabilities.

Installation of beam transport in XTD2

In 2014, the X-Ray Optics and Beam Transport group started to install ultrahigh-vacuum components in the tunnel XTD2 (see Chapter 3, “Civil Construction”, Figure 2). A challenge was the air humidity inside the underground building. To reduce humidity, temporary walls and dehumidifiers were implemented around the installation area. The entire tunnel section was cleaned before the installation work could begin. Specially designed local cleanrooms were used to connect the particle-free ultrahigh-vacuum chambers and beam transport pipes. The top part of Figure 1 shows the spontaneous-radiation aperture that was the first larger X-ray optical component to be placed in XTD2.



Figure 1

Top A spontaneous-radiation aperture, which is designed to set a defined aperture around the X-ray laser beam, is positioned about 200 m from the X-ray laser source point.

Bottom A special aluminium plate is glued to a concrete base that will support vibration-sensitive X-ray mirrors.

Some of the X-ray optical elements are extremely sensitive to vibrations, for example the mirrors that guide the X-ray laser beams over many hundreds of metres towards the experiment hall. Their placement is particularly challenging at the end of the XTD2 tunnel, where the X-ray laser beam is located about 2.6 m above the floor level very close to the tunnel wall. Large concrete blocks were cast in place to support these mirrors. On top of the concrete blocks will be a precision-ground granite slab that holds a vacuum chamber with the mirror inside. To obtain a perfectly flat and vibration-free interface between concrete and granite, a cast and milled aluminium plate was grouted with special epoxy glue to the concrete (Figure 1, bottom).

X-ray mirrors

To guide the X-ray laser beams to the experiments, X-ray mirrors of about 1 m length will be used. Crucial to the performance of these mirrors is an ultrasmooth surface finish that should deviate no more than 2 nm from an ideal flat. The company JTEC Corporation in Kobe, Japan, was able to achieve this polishing quality for the first time on a comparable mirror in 2014. JTEC has started to polish the 10 long mirrors required for the beam transport of the European XFEL.

A particular challenge is to keep this flatness and surface quality under “real-life” conditions when the X-ray laser beam hits the mirror surface. Although more than 95% of the X-ray intensity is reflected, a few watts will be absorbed. The largest effect occurs on the first mirror of each beamline, which is hit by a sizable amount of high-energy background radiation from the undulators in addition to the laser radiation. To minimize thermal deformations, these mirror substrates are shaped in a special way that directs a part of the heat flux towards the rear side of the mirror (Figure 2), such that the average thermal bending is almost zero. This novel design will be implemented for the first offset mirror of each beamline and for the distribution mirrors.

Metrology lab

The quality of the X-ray laser beams at the European XFEL will be significantly influenced by the quality of the mirrors used for beam transport and for focusing at the scientific instruments. It is crucial to verify the quality of the mirrors before their first installation and also periodically after some time of use. To this end, the X-Ray Optics and Beam Transport group built up a metrology facility in one of the X-ray free-electron laser (FEL) labs at the PETRA III facility at Deutsches Elektronen-Synchrotron (DESY). The most important tool is a large Fizeau interferometer, which was delivered to European XFEL in 2014 (Figure 3). The interferometer can assess surfaces up to 30 cm in

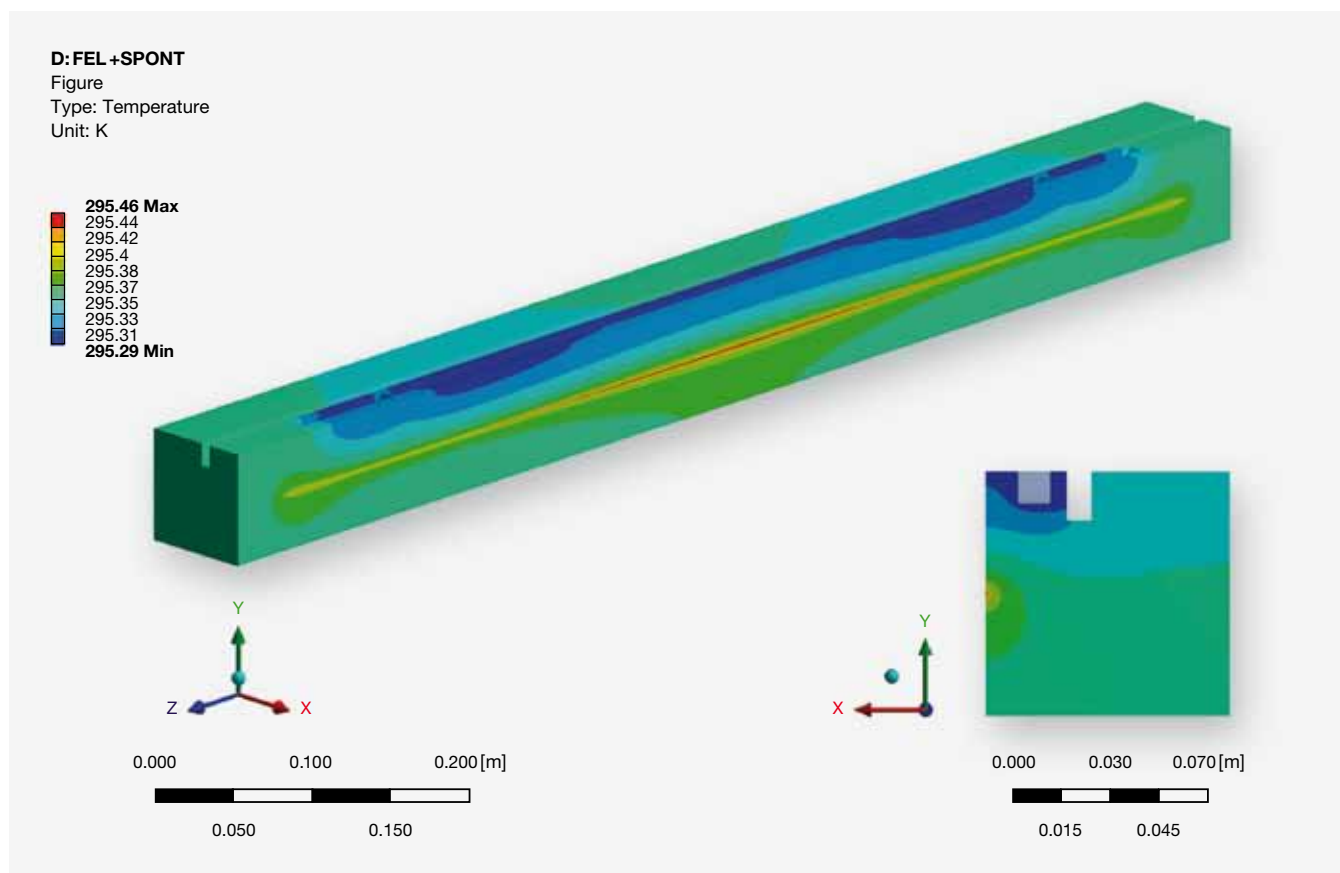

Figure 2 Design of non-bendable mirrors for the X-ray beam transport. The cross-section of the 900 mm long substrate is 75 x 75 mm. The heat flow is guided by the two grooves on the top surface (see insert in lower-right corner), such that the overall thermal bending is minimized.

Installation of the X-ray beam transport components for the SASE1 and SASE3 instruments in the remaining tunnels will start in early 2015. At the same time, acceptance tests and the assembly of components will continue. The first ultrapolished mirrors will arrive in mid-2015 and be tested at the PETRA III metrology laboratory.

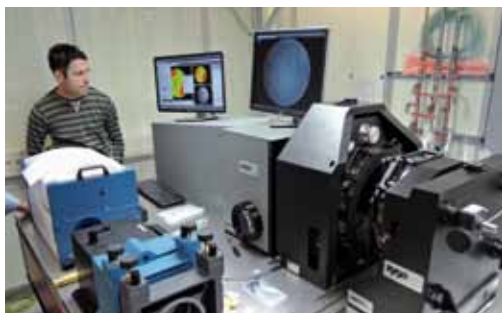

Figure 3 Setup of the Fizeau interferometer in the PETRA III laboratory at DESY

diameter in a single measurement with acquisition rates of up to 80 Hz. Longer mirrors can be measured either by stitching together several pictures at different mirror positions or by using the interferometer at a grazing beam angle. After the laboratory infrastructure is available on the main campus in Schenefeld, the metrology equipment will be moved there to minimize the transport of sensitive optics.

Outlook for 2015

Installation of the remaining X-ray beam transport components for the SASE1 and SASE3 instruments will start in early 2015. At the same

time, acceptance tests and the assembly of components will continue in the vacuum laboratory in the HERA South building. The first ultrapolished mirrors will arrive in mid-2015 and be tested at the PETRA III metrology laboratory. ■

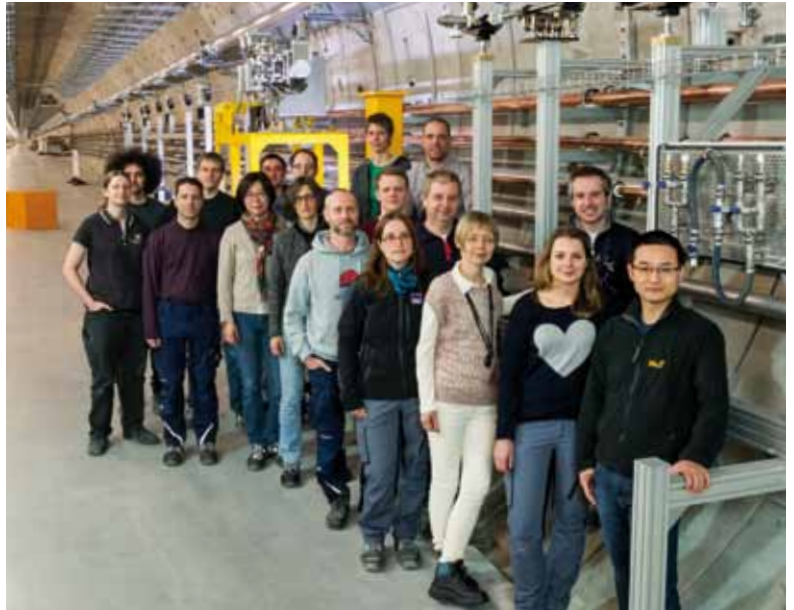

Group members

(left to right) Janni Eidam, Raúl Villanueva Guerrero, Maurizio Vannoni, Martin Dommach, Fan Yang, Daniele La Civita, Timo Korsch, Liubov Samoylova, Maik Neumann, Antje Trapp, Paul Frankenberger, Nicole Kohlstrunk, Alexander Bartmann, Harald Sinn (group leader), Natalia Gerasimova, Bianca Dickert, Massimiliano Di Felice, Xiaohao Dong, Shafagh Dastanjani Farahani (student, from June until November 2014, not shown), Idoia Freijo Martin (not shown), Oliver Henschel (intern, from April until July 2014, not shown), Jan von Appen (intern, from September until December 2014, not shown)

X-RAY PHOTON DIAGNOSTICS

The X-Ray Photon Diagnostics group is responsible for designing, constructing, and eventually operating the diagnostics devices that will measure and monitor the properties of the X-ray photon pulses generated by the European XFEL, such as pulse intensity, position, and spectral and temporal information. In 2014, the construction and assembly of final devices advanced: most notably, the first full X-ray gas monitor, the first photoelectron spectrometer, and many standard imagers were produced, and first support structures were installed in the tunnel.

Overall progress

The production of final diagnostics devices, which started in 2013, continued in 2014, extending to more types of devices. The commercial supplier JJ X-Ray from Kongens Lyngby, Denmark, delivered the imaging stations for beam alignment, and these 14 systems were approved after testing of their mechanical and vacuum properties. The first fully equipped X-ray gas monitor (XGM) was assembled on a girder and tested with synchrotron radiation. A first photoelectron spectrometer (PES, Figure 1) was assembled and shipped for experiments at the Linac Coherent Light Source (LCLS) in Menlo Park, California, in 2015.

The X-Ray Photon Diagnostics group was involved in relative arrival time measurements at the SPring-8 Angstrom Compact Free Electron Laser (SACLA) in Hyogo, Japan, and in the first online, non-destructive, and shot-resolved polarization monitoring at an X-ray free-electron laser (FEL) after similar experiments at a smaller extreme-ultraviolet FEL in 2013 [1].

The first fully equipped X-ray gas monitor was assembled on a girder and tested with synchrotron radiation. A first photoelectron spectrometer was assembled and shipped to California for experiments.

Gas-based intensity and position monitors

The XGMs are gas-based intensity and position monitors, contributed by Deutsches Elektronen-Synchrotron (DESY), Germany. In 2014, the dynodes of the two huge-aperture open multiplier (HAMP) chambers were improved and showed sufficient signal gain in experimental tests at Physikalisch-Technische Bundesanstalt (PTB) in Berlin, Germany. The first fully functional XGM device with four vacuum chambers on a common girder was assembled and calibrated. Five more devices are under construction for tunnel installation in 2015.

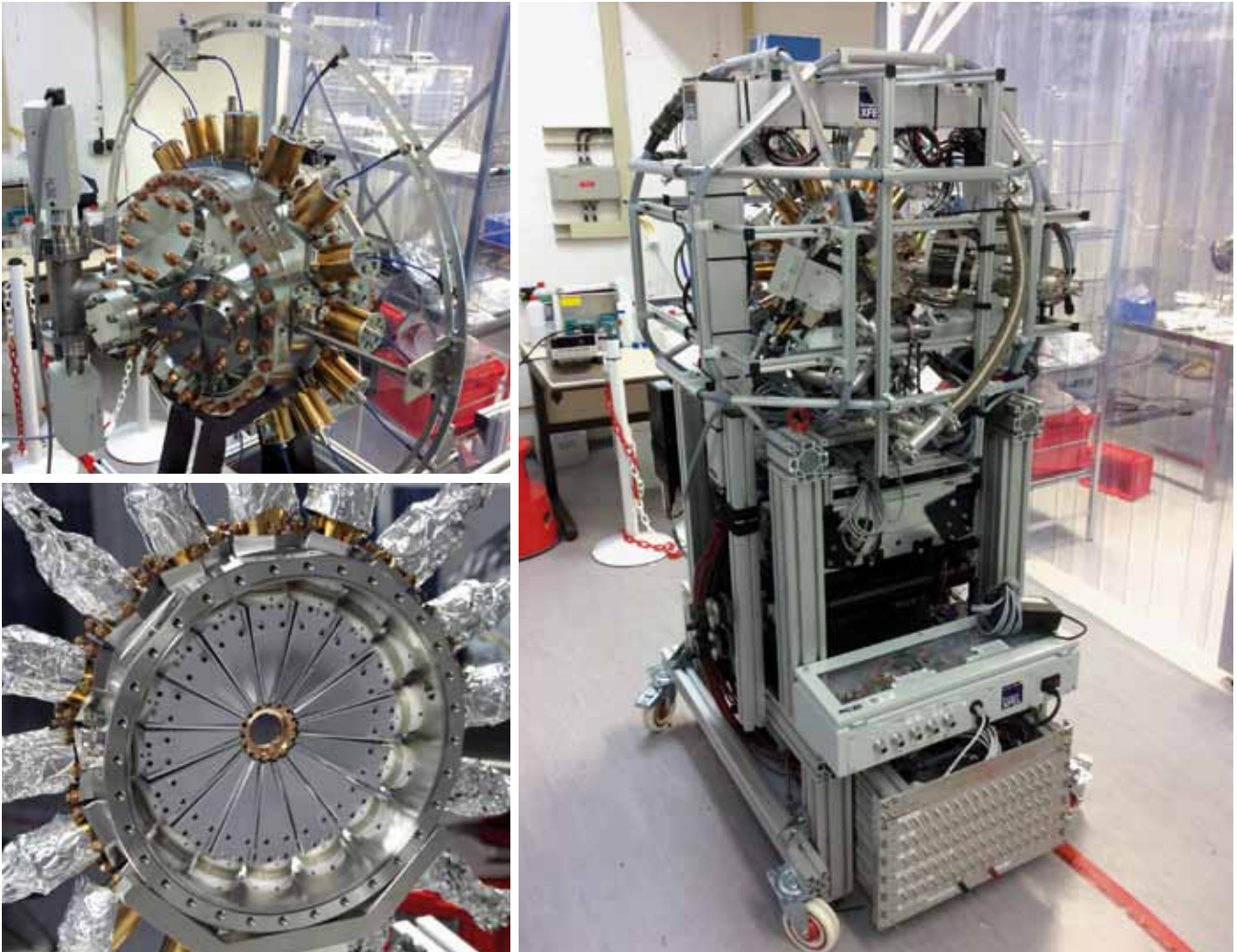

Figure 1 European XFEL photoelectron spectrometer, colloquially called the “cookie box” due to the resemblance of its central chamber to a box of Danish cookies

Online photoelectron spectrometer

In the fourth quarter of 2014, the X-Ray Photon Diagnostics group, together with the PETRA III (P04) group at DESY, supported the commissioning of the DELTA undulator, a novel device for variable-polarization control at LCLS, by providing genuine online polarization monitoring with a PES. The PES proved an invaluable diagnostics tool for this purpose. For these tests, a device from DESY was used. In the meantime, the group has achieved a major milestone by completing the construction of the first European XFEL PES (Figure 1), designed for later installation in the SASE3 tunnel. In 2015, the group will carry out polarization experiments at LCLS using the European XFEL PES, while demonstrating the performance of the device at an X-ray FEL.

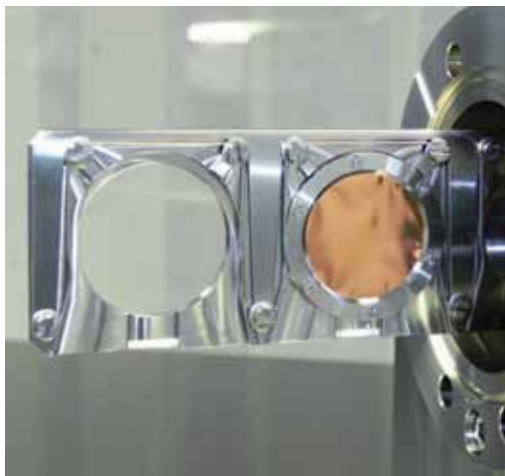

Figure 2 Mounted filter foils

A test stand for the associated differential-pumping system was defined for performance tests with a reduced number of pumps compared to the original design, which might lead to a more economical final installation.

Undulator commissioning spectrometer system

Assembly of the undulator commissioning spectrometer (*K* monochromator) for the SASE1 undulator beamline was completed. All changes required to turn the prototype into the full SASE1 version were implemented, and vacuum tests were successfully performed. A prototype control electronics crate was being tested at the end of 2014 and will be further optimized. Directly downstream of the *K* monochromator, a spontaneous-radiation (SR) imager serves as a detection system.

For energy calibration and diagnostics purposes, it will be necessary to insert filters and attenuators into the X-ray beam. This system will only be used with SR or FEL beams with low pulse energy together with the *K* monochromator and the SR imager. The design of the filter chamber was completed, all parts for tunnel installation were ordered, and the manipulator was equipped with foils (Figure 2).

Diagnostic imagers

A considerable part of all diagnostic imagers—14 devices out of 25 for the whole facility—were manufactured and delivered to European XFEL in 2014. This was achieved in collaboration with JJ X-Ray.

Figure 3 shows a pop-in monitor Type I mounted on its pillar for the site acceptance test (SAT). Pillars for all imagers were installed in XTD2, one of the tunnels of the SASE1 beamline and the first tunnel to be equipped (see Chapter 3, “Civil Construction”, Figure 2).

The focus in 2014 was on the mechanical design of the “2D-imager-FEL” and the “2D-imager-SR” as well as on the optical design of all imagers, including the pop-in monitors. Less effort is required for the transmissive imager, which is provided by DESY; modifications of its scintillator holder are being manufactured. The design and fabrication of the exit slit imager will start at the beginning of 2015.

All imagers will be ready in time for installation in XTD2. Provisions for the data acquisition (DAQ), control, and image processing have been started and will become more prominent in 2015. All functional tests of the imagers show the expected performance. For some critical components, especially the scintillators, tests with new materials are under preparation to mitigate risks.



Figure 3

Left Pop-in monitor Type I, fully mounted on adjustment plates and support pillar, at the HERA South lab during SAT.

Right Concrete platforms and pillars for 2D-imager-FEL and pop-in monitor Type II-45 in tunnel XTD2.

Temporal diagnostics

Promising diagnostic methods were proposed in 2013 for monitoring temporal beam properties, such as THz streaking to determine pulse length and spectral encoding to measure arrival time. In 2014, a THz generation prototype was built and tested. A requirements report for THz streaking in the Small Quantum Systems (SQS) instrument was prepared and is under review. Technical design requirements and a streaking chamber draft were discussed. Collaborations with LCLS, Paul Scherrer Institut (PSI) in Villigen, Switzerland, Center for Free-Electron Laser Science (CFEL) in Hamburg, Germany, and DESY are well established, and previous collaboration experiments were published [2]. Jia Liu, who specializes in this topic, participated in measurements based on THz streaking and spectral encoding at DESY's FLASH facility, LCLS, and SACLA. High-repetition-rate white-light generation based on gas phase and solid targets is ready to start in 2015 together with shot-to-shot high-repetition-rate detection using a Gotthard detector version for visible light.

All imagers will be ready in time for installation in XTD2. Provisions for the data acquisition control, and image processing have been started and will become more prominent in 2015.

More diagnostics

The Joint Institute for Nuclear Research (JINR) in Dubna, Russia, contributes the microchannel-plate-based detectors. JINR delivered the vacuum vessels and mechanics of the SASE2 and SASE3 devices, completed a detector modification, and finalized the SASE1 device assembly including delicate in-vacuum parts. This device also passed DAQ tests with ultraviolet light using the final DAQ hardware.

In parallel to device construction and installation, the group will continue to participate in experiments at existing X-ray FELs, with the aim of exploring and implementing novel diagnostics methods for European XFEL users.

The group's collaborators at Helmholtz-Zentrum Berlin (HZB) in Germany provided ray-tracing simulations of a hard X-ray high-resolution single-shot spectrometer (HX-HR-SSS). Transmissive gratings in these bent-crystal monitors allow for minimally invasive monitoring of each single-shot spectrum with high resolution while avoiding damage to the monitor itself. The arrival of the new staff scientist Naresh Kujala at European XFEL provided further impetus for this project. The technical specification for tendering and the design report were prepared and are currently under review.

Summary and outlook

In 2015, group staffing for the construction phase will be completed with the arrival of an electronics engineer in January. Installation of sensitive components in the tunnels will start with the vacuum systems of the SASE1 devices, with the SASE3 tunnel area following in mid-2015. As in previous years and in parallel to device construction and installation, the group will continue to participate in experiments at existing X-ray FEL facilities, with the aim of exploring and implementing novel diagnostics methods for the future European XFEL users. ■

References

- [1] **Control of the Polarization of a Vacuum-Ultraviolet, High-Gain, Free-Electron Laser**
 E. Allaria, B. Diviacco, C. Callegari, P. Finetti, B. Mahieu, J. Viefhaus, M. Zangrando, G. De Ninno, G. Lambert, E. Ferrari, J. Buck, M. Ilchen, B. Vodungbo, N. Mahne, C. Svetina, C. Spezzani, S. Di Mitri, G. Penco, M. Trovó, W.M. Fawley, P.R. Rebernik, D. Gauthier, C. Grazioli, M. Coreno, B. Ressel, A. Kivimäki, T. Mazza, L. Glaser, F. Scholz, J. Seltmann, P. Gessler, J. Grünert, A. De Fanis, M. Meyer, A. Knie, S.P. Moeller, L. Raimondi, F. Capotondi, E. Pedersoli, O. Plekan, M.B. Danailov, A. Demidovich, I. Nikolov, A. Abrami, J. Gautier, J. Lüning, P. Zeitoun, L. Giannessi
 Phys. Rev. X **4**, 041040 (2014)
 doi:10.1103/PhysRevX.4.041040
- [2] **Sub-femtosecond precision measurement of relative X-ray arrival time for free-electron lasers**
 N. Hartmann, W. Helml, A. Galler, M.R. Bionta, J. Grünert, S.L. Molodtsov, K.R. Ferguson, S. Schorb, M.L. Swiggers, S. Carron, C. Bostedt, J.-C. Castagna, J. Bozek, J.M. Glowia, D.J. Kane, A.R. Fry, W.E. White, C.P. Hauri, T. Feurer, R.N. Coffee
 Nature Photonics **8** (9), 706–709 (2014)
 doi:10.1038/nphoton.2014.164

**Group members**

(left to right) Florian Dietrich, Naresh Kujala (since November 2014), Jia Liu, Marc Planas, Bernard Baranašić (since January 2015), Wolfgang Freund, Jan Grünert (group leader), Jens Buck (not shown), Leif Glaser (since July 2014, not shown), and Andreas Koch (not shown)

06

SCIENTIFIC INSTRUMENTS AND EQUIPMENT

The scientific instrument groups spent 2014 putting the finishing touches on layout plans and began producing and procuring parts while collaborating with engineers, optical laser experts, and sample specialists to work out the final fine details.

Working at the optical laser laboratory





SCIENTIFIC INSTRUMENT FXE

The Femtosecond X-Ray Experiments (FXE) instrument will enable time-resolved pump–probe experiments on ultrafast time scales for a broad scientific community. While the first components have already been manufactured, the FXE group is furthering the design of the remaining components in research campaigns using laboratory laser sources, synchrotron sources combined with the FXE MHz laser system, and free-electron lasers (FELs).

Progress in 2014

Following the publication of its technical design report in 2012, the FXE group continued to work on the final instrument design (Figure 1) together with its in-kind contributing partner, Technical University of Denmark (DTU) in Lyngby and their subcontractor JJ X-Ray. This work included the fabrication of the first components for the FXE instrument—the high-power X-ray slits—and the von Hamos secondary spectrometer (Figure 2). The spectrometer was extensively tested during the factory acceptance test (FAT) in May and was subsequently delivered to European XFEL. Follow-up tests revealed an issue with the spring-loaded crystal mounts, which were successfully upgraded as a result.



Figure 1 Design of the FXE instrument



Figure 2 Von Hamos spectrometer during mounting of cylindrically bent X-ray crystals

Regular meetings with the contracting company and a DTU expert were beneficial to improving the design state of several components of the FXE instrument. Further components—part of a second Danish IKC—were designed in collaboration with other scientific instruments, which will receive nearly equivalent devices. Overall, many beamline components, including the solid attenuator and the compound refractive lens assemblies, are now being manufactured. Rollout of these key components thus started on time in 2014. The FXE project is well within schedule.

A new postdoc, Dmitry Khakhulin, joined the FXE group to work on transient wide-angle X-ray scattering (WAXS) studies of photoexcited solutes in liquid media. This is possible through a project within the Hamburg Centre for Ultrafast Imaging (CUI) in Germany.

Scientific experiments

In June 2014, the FXE group led a beamtime at the SPring-8 Angstrom Compact Free Electron Laser (SACLA) in Hyogo, Japan, to investigate the ultrafast generation of penta-coordinated $[\text{Fe}(\text{CN})_5]^{3-}$ following $(\text{CN})^-$ ligand photodetachment from aqueous $[\text{Fe}(\text{CN})_6]^{4-}$. $[\text{Fe}(\text{CN})_5]^{3-}$ was expected to promptly associate a solvent ligand to (re-)generate a six-fold coordinated complex. These experiments were prepared by time-resolved synchrotron radiation studies at the Advanced Photon Source (APS) of Argonne National Laboratory (ANL) in Argonne, Illinois. The surprising results, which are still being analysed, point to a long-lived penta-coordinated complex with a lifetime of around 5 ns, which has not been recognized by the scientific community so far.

The FXE group also participated in an experiment at the Linac Coherent Light Source (LCLS) at SLAC National Accelerator Laboratory in Menlo Park, California, on photoexcited $[\text{Fe}(\text{bpy})_3]^{2+}$ undergoing a low-spin to high-spin transition. The results were published in *Nature* [1].

Teaching and educational activities

As adjunct professor for physics at DTU, group leader Christian Bressler held a lecture in May 2014 promoting the new scientific opportunities at the European XFEL. Together with group member Andreas Galler, during the summer semester 2014, he also taught the course “Light–Matter Interactions: Atoms, Molecules, and (Non)linear Optics” at the University of Hamburg, Germany, which was selected by CUI as its main lecture. The course was a welcome occasion to describe the research opportunities soon available at the new world-class light source to Hamburg students and young scientists, with the hope of attracting them to future European XFEL–related science activities.

Outlook for 2015

In 2015, the FXE group will design the remaining instrument parts, start to manufacture them, and test them at leading synchrotron radiation facilities, possibly even at FELs, before their installation at the European XFEL. Many components will be stored on the contractor's premises so they can be delivered as soon as the experiment hall becomes accessible. At the same time, the FXE group will continue to teach courses at DTU and the University of Hamburg as well as carry out experimental campaigns at APS, SACLA, LCLS, and the PETRA III facility at Deutsches Elektronen-Synchrotron (DESY) in Hamburg, Germany. ■

References

- [1] Tracking excited-state charge and spin dynamics in iron coordination complexes**
W. Zhang, R. Alonso-Mori, U. Bergmann, C. Bressler, M. Chollet, A. Galler, W. Gawelda, R.G. Hadt, R.W. Hartsock, T. Kroll, K. S. Kjær, K. Kubiček, H.T. Lemke, H.W. Liang, D.A. Meyer, M.M. Nielsen, C. Purser, J.S. Robinson, E.I. Solomon, Z. Sun, D. Sokaras, T.B. van Driel, G. Vankó, T. Weng, D. Zhu, K.J. Gaffney
Nature **509**, 345–348 (2014)
doi:10.1038/nature13252
- [2] Solvation dynamics monitored by combined X-ray spectroscopies and scattering: photoinduced spin transition in aqueous $[\text{Fe}(\text{bpy})_3]^{2+}$**
C. Bressler, W. Gawelda, A. Galler, M.M. Nielsen, V. Sundström, G. Doumy, A.M. March, S.H. Southworth, L. Young, G. Vankó
Faraday Discuss. **171**, 169–178 (2014)
doi:10.1039/C4FD00097H

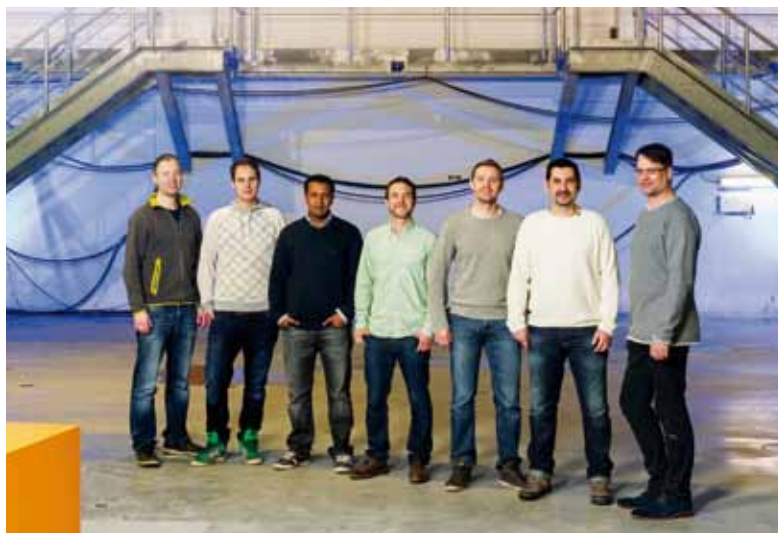

Group members

(left to right) Andreas Galler, Michael Diez (student, since January 2015), Tadesse Abebaw Assefa (student), Alexander Britz (student), Dmitry Khakhulin (postdoc, CUI, University of Hamburg), Wojciech Gawelda, Christian Bressler (group leader)

SCIENTIFIC INSTRUMENT HED

The High Energy Density Science (HED) instrument will be a unique platform for experiments combining hard X-ray free-electron laser (FEL) radiation and the capability to place matter under extreme conditions of pressure, temperature, or electric field using high-energy optical lasers or pulsed magnets. Scientific applications will include studies of the properties of matter within exoplanets, new extreme-pressure phases and solid-density plasmas, and structural phase transitions of complex solids in high magnetic fields. In 2014, the technical design report (TDR) for the HED instrument was published, and the enclosure to house the experiment setup was erected inside the experiment hall.

Progress in 2014

In 2014, the HED group focused on the completion of the instrument layout, implementing the requirements provided by its future user community, and on the initial construction work and first procurements for the HED instrument. The year started with an HED user workshop at the European XFEL Users' Meeting in January. At this meeting, which was attended by more than 60 people, the technical design of the HED instrument was presented and last input was collected. In March, the TDR for the HED instrument was reviewed by the HED advisory review team (ART), leading to the publication of the report in May [1] after a positive evaluation by the ART. First procurements of devices and further design definitions for complex components, such as the detectors and the large interaction chamber, followed. Another responsibility of the group was the construction of the HED experiment enclosure. To this end, the group first wrote the corresponding radiation safety document, which was discussed and approved by the regulating authorities. The construction of the enclosure was completed in August. In close collaboration with the Helmholtz International Beamline for Extreme Fields at the European XFEL (HIBEF) user consortium (UC) and other external partners, the group prepared the integration of external contributions into the HED instrumentation.

In 2014, the group focused on the completion of the instrument layout and on the initial construction work and first procurements.

Throughout the year, HED group members participated in several international conferences and workshops and presented the instrument and its science portfolio to the user community. Several papers on the HED instrument in general and on specific components were published (e.g. [2]).

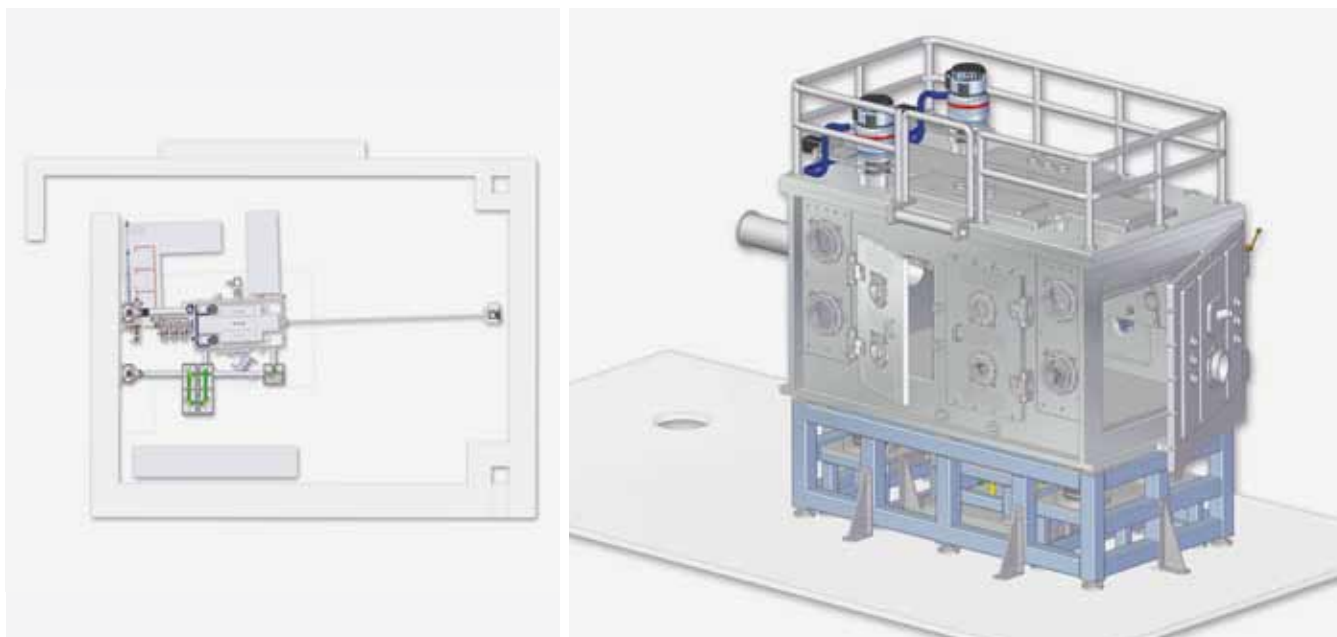

Figure 1 Current design of the HED experiment room and interaction chamber.
Left Layout of the HED experiment room (HED-EXP) without HIBEF installations.
Right Layout of the large interaction chamber.

In the experiment room, an ultrahigh-intensity laser will drive solid matter to very high excitation states, where electrons achieve relativistic energies.

Completing the instrument layout

Following a suggestion by the ART, the HED group later visited several high-power laser facilities to collect know-how and experience to be included in the design of the large interaction chamber, combining the various laser beams, the X-ray beam, and the sample positioning system. Figure 1 shows the present layout of the experiment room (HED-EXP) and of the large vacuum chamber. Another follow-up of the TDR effort was to decide what detectors should be employed at the HED instrument. This task required considerable effort and could not be completed by the end of 2014. A major problem is the user request for coverage of large solid angles, similar to what is available for X-ray diffraction experiments at synchrotron radiation sources. This request is in conflict with other requirements of the instrument design, such as avoiding windows in the X-ray beam and maintaining a high flexibility in the setup. The HED group has already started to select appropriate area detector solutions. This work will continue in 2015. In parallel, first parts of the X-ray beam delivery system (slits, attenuators, and several compound refractive beryllium lens changer units for the HED focusing system) were ordered as part of an in-kind contribution from Technical University of Denmark (DTU) in Lyngby.

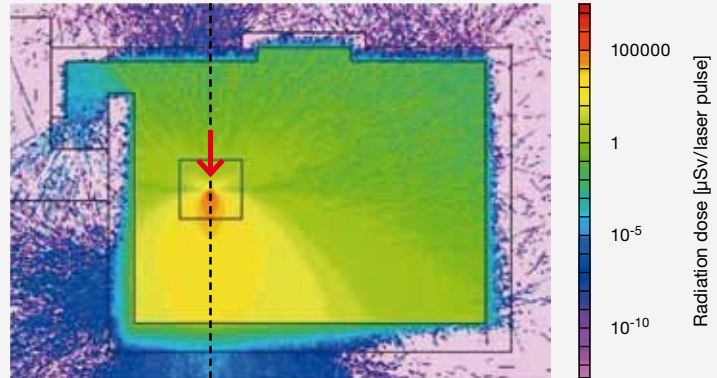

Figure 2 HED experiment enclosure.

Left Completed HED experiment enclosure.

Right Simulation results for radiation doses generated by the ultrahigh-intensity optical laser (UHI-OL). (Simulation courtesy of A. Ferrari, HZDR)

Construction and radiation safety assessment of HED-EXP

In HED-EXP, an ultrahigh-intensity laser will be used to drive solid matter to very high excitation states, where electrons achieve relativistic energies. These states of relativistic laser–matter interaction will then be studied using the high brightness and ultrashort X-ray FEL flashes of the European XFEL. As the electrons also emit secondary radiation, an analysis of the radiation doses is required. The need to contain this radiation inside the HED-EXP area sets the requirements for the radiation shielding that must be provided by the HED-EXP walls. Helmholtz-Zentrum Dresden-Rossendorf (HZDR) in Germany, which has several years of experience in this domain, performed Monte Carlo simulations for the conditions at the HED instrument, considering a 100 TW laser with a pulse energy on sample of 3 J operating at a repetition rate of 10 Hz. This study yielded results indicating that heavy concrete and wall thicknesses of 0.5–1.0 m would be the most efficient shielding. It further served to refine the layout and requirements of the HED experiment enclosure. Due to the large weight of the enclosure, it was necessary to construct it before applying the final coating of the experiment hall floor. Construction of the enclosure started in July and was completed in August (Figure 2).

Construction of the HED experiment enclosure started in July and was completed in August.

User consortia and other collaborations

Major emphasis in 2014 was placed on the interaction with the HIBEF UC and other possible partners. Significant contributions to the instrumentation and personnel at the HED instrument by these external partners appear likely. In the summer, HIBEF partners in the UK received funding to build a diode-pumped nanosecond 10 Hz and 100 J laser system to be installed at HED. This DIPOLE-100-X laser will enable dynamic-compression experiments reaching pressures of up to 1 TPa and sustain the high repetition rate and operational performance required for the European XFEL facility. The system will be installed in early 2017 at the HED instrument. The definition of the 100 TW ultrashort-pulse laser is still in progress, as are many other contributions proposed by the HIBEF UC. The current HED design allocates extra space and makes other provisions to accommodate additional instrumentation at a later date. The contribution of an X-ray beam split and delay unit—developed and built by the group of Helmut Zacharias at the University of Münster, Germany, with funds from the German Federal Ministry of Education and Research (BMBF)—is progressing well, with the mechanics currently being assembled and tested. The device was already integrated in the 3D model of the XTD6 tunnel of SASE2 (see Chapter 3, “Civil construction”, Figure 2). The HED group also started discussions with partners from China, who are interested in initially collaborating on the HED instrument (for example, by designing and building spectrometers) and eventually becoming full partners in the European XFEL project.

Research and collaborations

In 2014, HED group members participated in FEL experiments at the Matter in Extreme Conditions (MEC) instrument at the Linac Coherent Light Source (LCLS) in Menlo Park, California, and at the SPring-8 Angstrom Compact Free Electron Laser (SACLA) in Hyogo, Japan, as well as in dynamic-compression experiments at Laboratoire pour l'Utilisation des Lasers Intense (LULI) in Palaiseau, France. Each of these experiments were performed by large international collaborations, and the data analysis and publication of results are ongoing. The HED group acquired valuable expertise during these experimental campaigns, which it has directly applied to the HED instrument design.

Outlook for 2015

In 2015, the HED group will continue to acquire components and prepare for the installation of the instrument during the second half of 2016. Very important components that will require early and full attention will be the detectors to be employed at HED and the large interaction chamber. Another urgent issue is the completion of the

execution planning of the SASE2 hutches and infrastructure. This execution planning is vital to keeping the proposed schedule of starting the instrument installation in summer 2016. Finally, the expected awarding of funding for HIBEF will create a lot of activity toward the definition and integration of the instrumentation contributed through this UC. ■

References

[1] Technical Design Report: Scientific Instrument High Energy Density Physics (HED)

M. Nakatsutsumi, K. Appel, G. Priebe, I. Thorpe, A. Pelka, B. Muller, Th. Tschentscher
XFEL.EU TR-2014-001
doi:10.3204/XFEL.EU/TR-2014-001

[2] Studying planetary matter using intense x-ray pulses

K. Appel, M. Nakatsutsumi, A. Pelka, G. Priebe, I. Thorpe, Th. Tschentscher
Plasma Physics and Controlled Fusion **57** (1), 014003 (2015)
doi:10.1088/0741-3335/57/1/014003

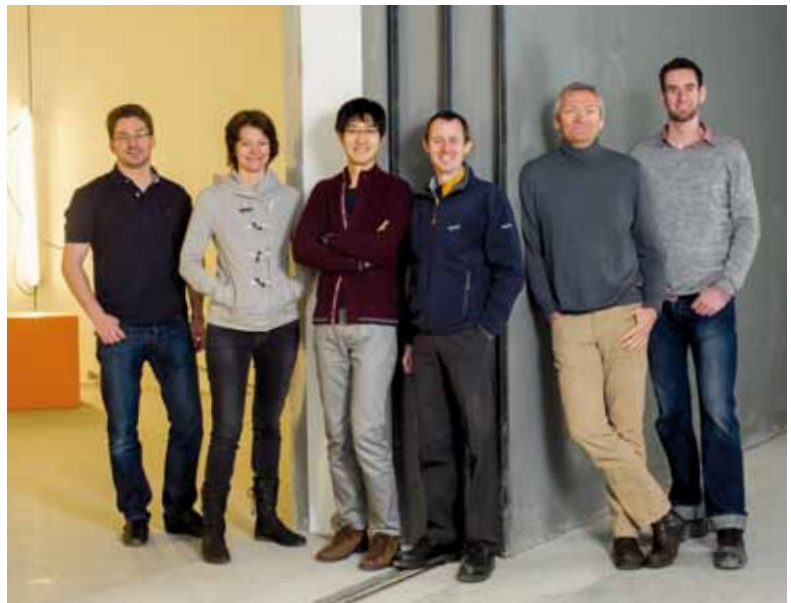

Group members

(left to right) Alexander Pelka (guest, from HIBEF), Karen Appel, Motoaki Nakatsutsumi, Ian Thorpe, Thomas Tschentscher (interim group leader), Andreas Schmidt (since January 2015, jointly with MID), and Gerd Priebe (from Optical Lasers group, not shown)

SCIENTIFIC INSTRUMENT MID

The aim of the Materials Imaging and Dynamics (MID) instrument is to enable studies of structure and dynamics in condensed matter by means of X-ray scattering and imaging experiments on the nanoscale. Further areas of application are materials science and nanomaterials. In 2014, the MID group went on designing various instrument components, experiment hutches, and infrastructure, and conducted related R&D with experiments at other light sources.

Progress in 2014

After approval of the technical design report (TDR) in 2013, the MID group continued the design work on various instrument components, experiment hutches, and infrastructure. The first call for tender for a part of the MID instrument was published in autumn 2014. It concerns a differential-pumping section that will allow window-free operation of the experiment station. An in-kind contribution agreement was concluded with Technical University of Denmark (DTU) in Lyngby concerning slits, attenuators, and X-ray lens manipulators to be produced for MID by DTU subcontractor JJ X-Ray. The layout of the hutches and instrument components in the experiment hall was almost finalized, as shown in Figure 1. The MID laboratory in the HERA South hall became fully operational in 2014 after installation of a laminar-flow tent, work benches, and optical tables. The laboratory serves as a test stand for the future optical laser systems at MID, but commissioning of mechanical parts and ultrahigh-vacuum components can also be done. First tests of Karabo—the European XFEL's control system, which is under development for instrument control and data acquisition—were also performed in the lab in 2014.

Together with the X-Ray Optics and Beam Transport group, the MID group specified a double mirror system to be installed in the experiment hutch.

Instrument design and construction

In 2014, the MID group continued to benefit from the collaboration with the Instrument Engineering group at European Synchrotron Radiation Facility (ESRF) in Grenoble, France, in designing instrument parts. The first tangible outcome was a complete 3D model of the differential-pumping section, which will be manufactured in 2015 by an external contractor. The next models to follow are the long detector arm and the experiment chamber. It is anticipated that the complete set of 3D models will be available by mid-2015, which will mark the successful completion of the engineering collaboration with ESRF.

Together with the X-Ray Optics and Beam Transport group, the MID group specified a double mirror system to be installed in the experiment hut. Two mirrors will be employed to send the beam either upward or downward to hit the sample. Downward deflection is required to direct the X-ray beam toward a liquid surface on which it will impinge at grazing incidence angles, for instance to study the structure and dynamics of surface layers. Deflection upward is required when the hard X-ray split and delay line (SDL) produces two beams that are vertically offset and the lower beam must be directed toward the interaction region so that both beams hit the sample with a controlled delay. The technical specification document for the double mirror will serve as the basis for the call for tender that will be launched in early 2015.

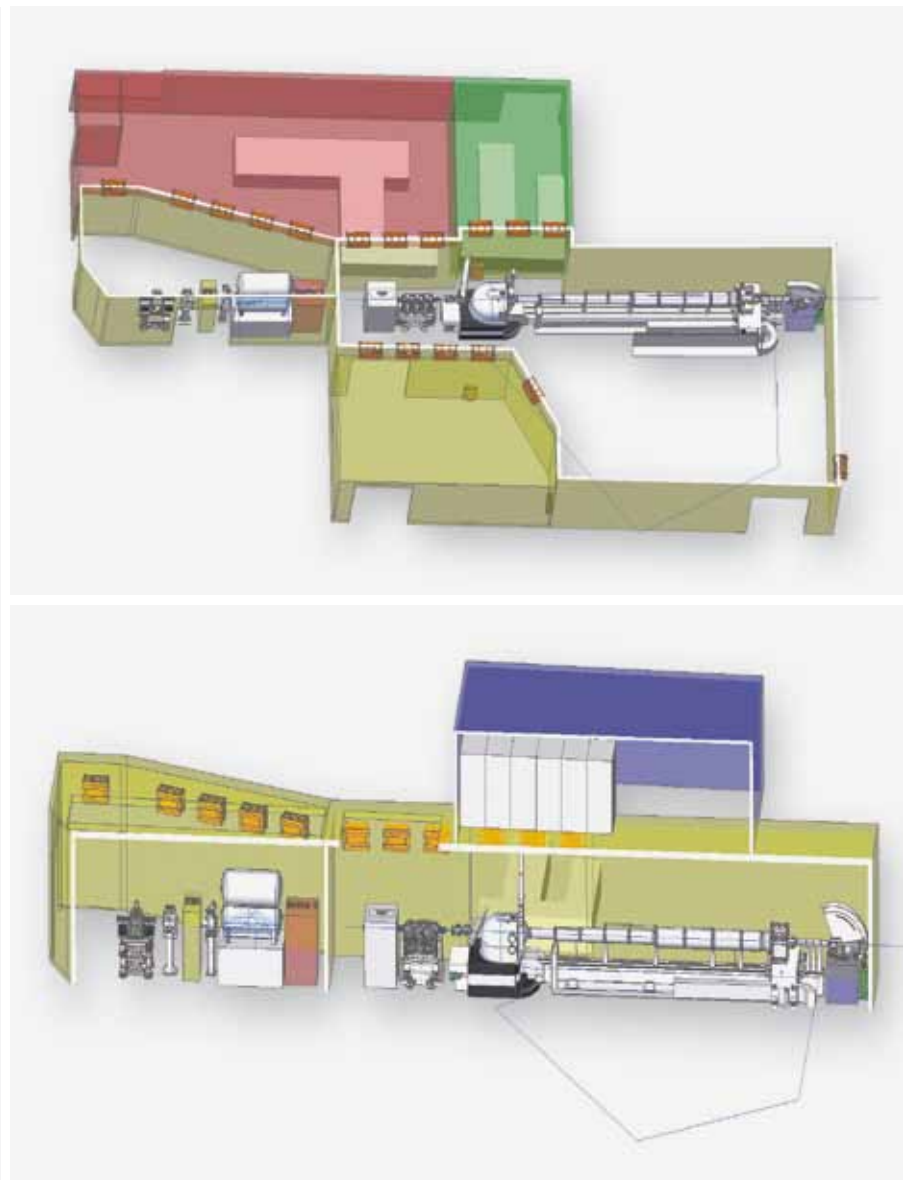

Figure 1 Top and side views of the MID hutches. The MID instrument with a large detector arm can be seen in the experiment hut. The optical laser hutches are sketched in green and red. The blue hutch on the roof of the experiment hut contains electronics racks.

In a contribution from Technische Universität Berlin (TU Berlin), Wei Lu started as a postdoc researcher in the MID group. His main task is the design of the SDL. The budget for the SDL, which includes the two-year postdoc position, is provided by a German Federal Ministry of Education and Research (BMBF) grant resulting from a collaboration between MID and Stefan Eisebitt's group at TU Berlin. In 2014, two prototype setups were designed to address fundamental questions relating to the mechanical precision of crystal motions inside the SDL and to assess important design aspects of a laser interferometer system that will be employed to track the position of the upper-branch crystals. The outcome of both prototype tests is crucial for determining whether the specifications for high stability and precise crystal motions can be met with the current mechanical design.

X-ray imaging and small-angle X-ray scattering experiments were used to study the structure of beryllium materials from which X-ray focusing lenses had been manufactured. The results are very promising for the future performance of the compound refractive lens system that was designed for the MID instrument.

Research and development

The MID group continued its research and development activities in 2014, for instance performing experimental work at ESRF. X-ray imaging and small-angle X-ray scattering experiments were used to study the structure of beryllium materials from which X-ray focusing lenses had been manufactured. The results, which are very promising for the future performance of the compound refractive lens system that was designed for the MID instrument, were communicated at the SPIE Optical Engineering + Applications conference in San Diego in August 2014 [1].

Furthermore, the MID group has been involved in test measurements of X-ray speckle visibility spectroscopy (XSVS) and X-ray photon correlation spectroscopy (XPCS) to track the dynamics of complex fluids. An experiment was conducted at ESRF to study the influence of ultraviolet light-mediated molecular reconfigurations on the dynamic properties of polymeric suspensions. XSVS is planned to be used together with split-pulse illumination at MID to measure ultrafast dynamics, but a series of test experiments are required before the technique, which is new in the X-ray domain, can be implemented. The study of dynamics by means of X-ray scattering continues in 2015, with planned beamtime as principal investigators at the Linac Coherent Light Source (LCLS) at SLAC National Accelerator Laboratory in Menlo Park, California, and at ESRF. Critical ordering and dynamics will be studied in a binary metallic copper-zinc (Cu-Zn) alloy also known as beta-brass, which is a textbook example of the Ising model. However, Cu-Zn crystals have only been rudimentarily investigated by means

of X-ray scattering because of technical difficulties. After thorough measurements of the static ordering by means of X-ray diffraction at the PETRA III synchrotron radiation facility at Deutsches Elektronen-Synchrotron (DESY), with results communicated at the 13th Surface X-ray and Neutron Scattering (SXNS) conference in Hamburg in July 2014, the MID group is now ready to investigate dynamics in the Cu–Zn system by means of XPCS at ESRF. Because coherent flux is limited at third-generation synchrotron sources, only slow dynamics very close to the critical point of Cu–Zn can be studied at ESRF. If the experiment is successful, the results will not only be of major interest in condensed-matter physics, but also point out an important technique to develop at MID in order to capitalize on the outstanding properties of the European XFEL.

At LCLS, the MID group will make a second attempt in 2015 to study atomic motion in an amorphous glassy system by recording high momentum transfer speckle patterns at 120 Hz repetition rate. A first try was made in 2013 but, due to various technical difficulties, the experiment was not performed under optimum conditions and hence the data quality was not good enough to draw any firm conclusions about the dynamics. Atomic dynamics in non-crystalline solids, such as glass formers, is notoriously difficult to study, and free-electron lasers could potentially provide a great leap forward if the experiments are performed in a controlled fashion, for instance through a better definition of the longitudinal coherence length using self-seeding.

In 2015, the design of most instrument parts will be finalized, several calls for tender for baseline instrumentation will be launched, and first components will be delivered. The final planning of the SASE2 infrastructure and MID hutches will be accomplished. A special granite floor will be laid early in the year.

Outlook for 2015

In 2015, the design of most instrument parts will be finalized, several calls for tender for baseline instrumentation will be launched, and first components will be delivered. The technical commissioning of all instrument components will initially take place in the MID laboratory in the HERA South hall. The final planning of the SASE2 infrastructure and MID hutches in the experiment hall in Schenefeld will be accomplished in 2015, and the first custom-made part of the MID instrument will become visible in the experiment hall in early 2015, when a special granite floor (~65 m²) will be laid. On this floor, an 8 m long arm carrying the Adaptive Gain Integrating Pixel Detector (AGIPD) will hover on air cushions, which will allow it to be moved inside the experiment hutch during instrument operation. The MID group will be involved in experiments at ESRF and LCLS, as outlined above,

to continue research programmes in condensed-matter physics and to explore novel opportunities provided by free-electron lasers. ■

References

[1] X-ray laminography and SAXS on beryllium grades and lenses and wavefront propagation through imperfect compound refractive lenses

T. Roth, L. Helfen, J. Hallmann, L. Samolyova, P. Kwasniewski, B. Lengeler, A. Madsen
Proceedings of SPIE **9207**, 920702 (2014)
doi:10.1117/12.2061127

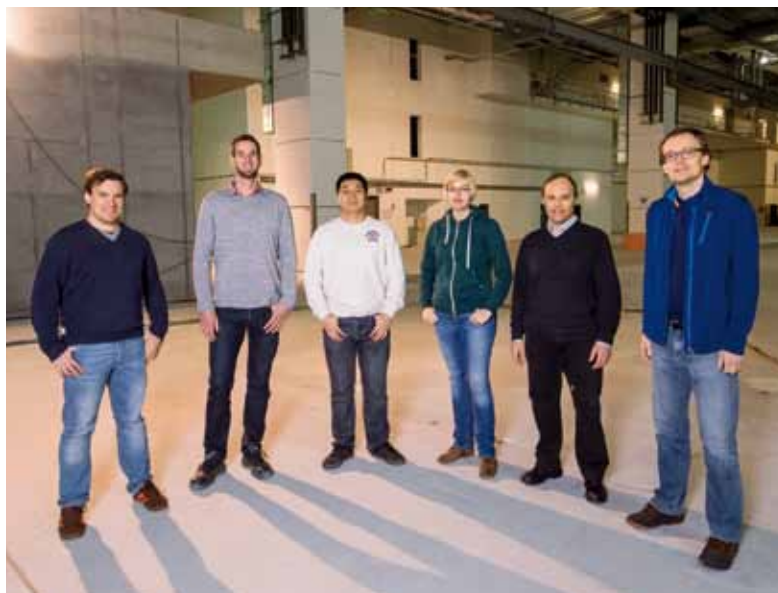

Group members

(left to right) Jörg Hallmann, Andreas Schmidt (since January 2014, jointly with HED), Wei Lu (postdoc, TU Berlin), Birthe Kist (student), Gabriele Ansaldo, Anders Madsen (group leader), Mario Reiser (intern, not shown), and Thomas Roth (not shown)

SCIENTIFIC INSTRUMENT SCS

The Spectroscopy and Coherent Scattering (SCS) group aims to deliver an instrument for small-angle scattering, resonant diffraction, and coherent diffraction imaging at soft X-ray energies for the European XFEL. Users will be able to explore the electronic, spin, and structural properties of solid-state samples in the smallest space–time dimensions with a versatile set of spectroscopic tools. In 2014, the SCS group developed the technical design report (TDR), proceeded with the final technical specifications and tendering of the first instrument components, and worked with the Heisenberg Resonant Inelastic X-ray Scattering (h-RIXS) user consortium on the integration of the RIXS instrumentation. In addition, the group carried out experiments to further advance the methodologies envisioned for the SCS instrument.

Technical design of the SCS instrument

In March 2014, the TDR for the SCS instrument was presented to the European XFEL Scientific Advisory Committee (SAC). The TDR comprises a detailed description of all SCS instrument components and the SCS infrastructure as well as an update of the X-ray and optical laser beam delivery systems and the ramifications of the SCS operations. The SCS group developed an SCS beamline computer code that allows start-to-end simulations of beam operations to be carried out for the diverse soft X-ray spectroscopic and scattering techniques. The X-ray beam transport was accordingly refined in the TDR. A beam offset compensation scheme will define an X-ray propagation path downstream from the Kirkpatrick–Baez (KB) focusing mirrors that is independent of the photon energy and the operation with monochromatic beam and will therefore make it significantly easier to change instrument setups and perform experiments.

Figure 1 Rendering of the instrumentation in the SCS experiment hutch. The figure shows the FFT experiment station right in front of the laser in-coupling, which is the last permanent SCS beamline component, and followed by the 6 m long detector girder that hosts the DSSC detector shown in the front. The high-resolution RIXS spectrometer is located on the left of the FFT experiment station on the high-planarity floor.

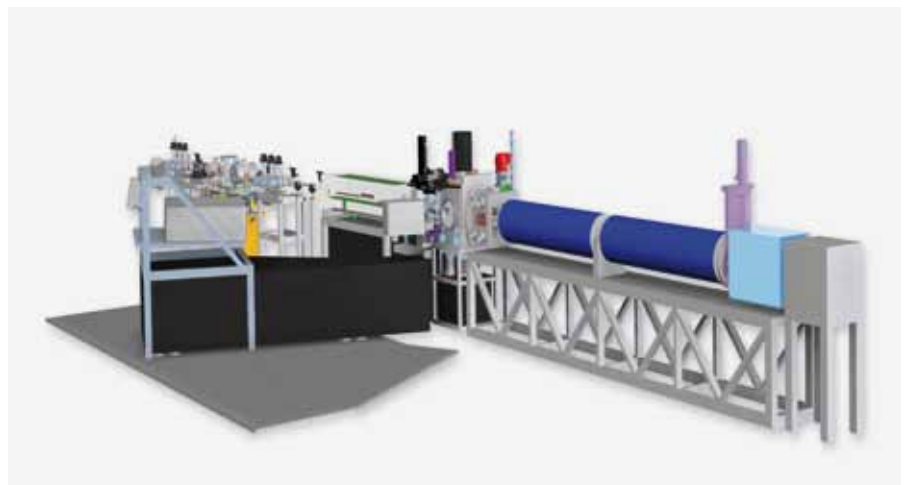

The SCS group proceeded with the final design and execution planning of the permanent beamline components and the forward-scattering fixed-target (FFT) experiment station and ordered the first device components to be constructed and tested at the beginning of 2015 in the SCS assembly lab in the HERA South building. An overview of the technical design of the SCS instrument in the experiment hutch is shown in Figure 1.

KB focusing optics with high-precision benders

The final technical design of the KB system consists of three mirrors. A pair of KB mirrors provides a micrometre-sized beam at nominal focus, and an additional vertically deflecting mirror preserves the outgoing beam horizontality. A sufficient beam quality at the sample position can be maintained for all photon energies (250 eV – 3 keV) if the error in the mirror shape is 150 nrad or below. For variable beam sizes up to millimetres, the KB system will require beyond-state-of-the-art bending mechanics for long mirror substrates (up to 700 mm) and small bending radii (down to 410 m) that can meet the maximum figure error of 150 nrad. The implementation of a cooling scheme and a rigid design of the mirror mounts and vessel is further required to minimize vibration of the X-ray optics. Based on the final KB technical specifications, the SCS group placed a public call for tender that was still in progress at the end of 2014.

The SCS instrument will use a large Depleted P-Channel Field Effect Transistor (DEPFET) Sensor with Signal Compression (DSSC) detector mounted on a 6 m long girder. In the final design phase of the FFT experiment station, the main focus was on the direct interface of the DSSC detector with the FFT chamber in a way that minimizes the sample–detector distance and allows for nearly wavelength-limited momentum transfer. Together with the Sample Environment group, the SCS group optimized and further specified the sample manipulation and experimental geometries in the FFT chamber.

h-RIXS user consortium and first integration steps

The h-RIXS user consortium proposed to build a high-resolution spectrometer that will facilitate RIXS experiments at the SCS instrument. The optical design of the spectrometer was finalized during several meetings held in Hamburg and Milano in 2014. A conceptual design report will be reviewed at the beginning of 2015. The high-resolution spectrometer can rotate around the sample position, covering a maximum outer radius of 5 m, with a high degree of positioning accuracy during experiments. A precise movement on the floor will be achieved thanks to a high-planarity floor (70 μm variation over 1 m^2) in the SCS experiment hutch (Figure 2) where the spectrometer can hover on stiff air pads 50 μm above the floor.



Figure 2 Inspection of the recess clearance for the SCS high-planarity floor after the casting of the main concrete floor in the experiment hall (XHEXP1)

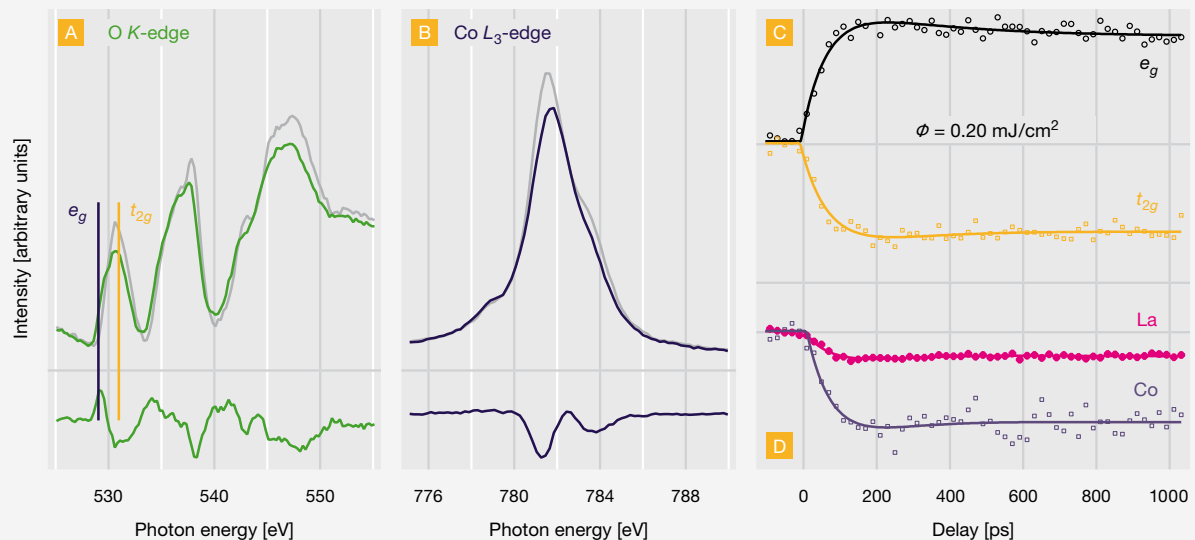

Figure 3 Optical pump–X-ray reflectivity probe obtained in LaCoO₃ at the BESSY synchrotron of HZB.

Pump–probe reflectivity results obtained at the BESSY synchrotron at HZB.

- (A)** Unpumped (grey) and pumped (green) reflectivity scans across the O *K*-edge and the difference between them (bottom). The vertical lines indicate the energy positions at which the empty O *2p* states hybridize with empty Co *3d t_{2g}* (orange line) and *e_g* (blue line) sublevels.
- (B)** Unpumped (grey) and pumped (purple) reflectivity scans across the Co *L₃*-edge and the difference between them (bottom).
- (C)** Delay scans at the two energy positions of the O edge indicated by the lines in Panel (A). Φ : laser fluence.
- (D)** Delay scans of the white lines of the Co *L₃*- and La *M₅*-edges.

All the measured delay scans show that, after excitation, the system is locked into a new state within a time given by the pulse duration (50 ps). Detailed analysis of the data, together with density functional theory plus dynamical mean-field theory (DFT+DMFT), shows that the laser excitation induces a transient metallic state with larger high-spin component and charge disproportionation [1].

Laser-induced spin transition in LaCoO₃

In 2014, group member Manuel Izquierdo and scientific director Serguei Molodtsov published results from an ongoing collaborative project with the Theory group (see Chapter 5, “Photon Beam Systems”) [1]. The project is funded by the German Federal Ministry of Education and Research (BMBF) within the framework of a German–Russian call for “Development and Use of Accelerator-based Photon Sources”. This project aims at the detailed understanding of the spin transition in LaCoO₃ (LCO) and its role in the semiconductor-to-metal transition and the high-temperature metallic phase.

The picosecond dynamics of the laser-induced spin crossover in LaCoO₃ single crystals were investigated at the FEMTOSPEX beamline at the BESSY synchrotron at Helmholtz-Zentrum Berlin (HZB), Germany. The experimental results, shown in Figure 3, indicate the formation of a transient metallic state with large high-spin content and charge disproportionation upon laser excitation [1].

Laser-induced ultrafast nucleation of ferromagnetic order

The group's main research activity in 2014 was a beamtime at the Linac Coherent Light Source (LCLS) at SLAC National Accelerator Laboratory in Menlo Park, California, with the objective to study the laser-driven antiferromagnetic (AFM) to ferromagnetic (FM) phase transition in FeRh using the time-, element-, and spatially resolving technique of resonant X-ray diffraction (TR-RXD). FeRh is a prototypical system for the solid-state first-order phase transition where the magnetization is the order parameter. Using TR-RXD, the SCS group was able to determine the FM nucleation domain growth process with nanometre spatial resolution and femtosecond time resolution from the point of view of the electronic system. After the data analysis is finished, the results should offer important insight into the channels involved in the ferromagnetic ordering.

Using TR-RXD, the SCS group was able to determine the FM nucleation domain growth process with nanometre spatial resolution and femtosecond time resolution from the point of view of the electronic system. After the data analysis is finished, the results should offer important insight into the channels involved in the ferromagnetic ordering.

In addition to its scientific merit, this experiment directly informs the design of the SCS instrument. One of the key objectives of the instrument is to push the TR-RXD technique to the smallest space–time dimensions, on the order of the X-ray wavelength, down to 1 nm length scales. Furthermore, to achieve the highest time resolution possible in the experiment, the group utilized X-ray pulse arrival diagnostics similar to those envisaged for the European XFEL, thereby gaining valuable insights into their practical implementation and their integration into the data analysis.

Outlook for 2015

In 2015, the SCS group will work on the assembly and tests of critical components of the SCS beamline. The experiment station and detector girder will reach the final design stage and their public tender will be initiated. The SCS group size will increase by hiring two new members for the final construction of the instrument. The group is looking forward to the completion of the SCS high-planarity floor before the SCS hutches are constructed in the second half of the year. ■

References**[1] Laser-induced charge-disproportionated metallic state in LaCoO_3**

M. Izquierdo, M. Karolak, C. Trabant, K. Holldack, A. Föhlisch, K. Kummer, D. Prabhakaran, A.T. Boothroyd, M. Spiwek, A. Belozarov, A. Poteryaev, A. Lichtenstein, S.L. Molodtsov
Phys. Rev. B **90**, 235128 (2014)
doi:10.1103/PhysRevB.90.235128

**Group members**

(left to right) Alexander Yaroslavtsev (guest), Manuel Izquierdo, Jan Torben Delitz, Robert Carley, and Andreas Scherz (group leader)

SCIENTIFIC INSTRUMENT SPB/SFX

The Single Particles, Clusters, and Biomolecules and Serial Femtosecond Crystallography (SPB/SFX) group is responsible for building a state-of-the-art scientific instrument for structural investigations of crystalline and non-crystalline matter—in particular for determining the structure of biological molecules. In 2014, the group incorporated key extensions to the instrument design, as proposed by the SFX user consortium (UC), to accommodate even more structural biology at the European XFEL.

Enhancing instrumentation for structural biology

In 2014, the group strengthened its relations with the SFX UC, which proposes to build a second interaction region for nanocrystallography and sample screening in the SPB/SFX hutch. In cooperation with the SFX UC, the group delivered the design report for additional SFX-related instrumentation and worked towards incorporating this new, additional instrumentation into the instrument design. Other major events in 2014 included the filling of several open positions, the ordering of key instrumentation, and further successful experiments that extend the boundaries of the structure determination methods to be used at SPB/SFX.

Increasing staff numbers

The SPB/SFX group, supported by additional hires made possible by the SFX UC, continued to grow in 2014. Patrik Vagovič joined the team in January, bringing expertise in X-ray optics. Tokushi Sato, an expert in time-resolved X-ray experiments, joined the team in March and quickly started to work on refining the design of the optical laser conditioning at SPB/SFX for time-resolved experiments. Both have been seconded to the SPB/SFX group from Center for Free-Electron Laser Science (CFEL) and Deutsches Elektronen-Synchrotron (DESY) in Hamburg as contributions to the SFX project.

Supporting the analysis efforts of the project, in June, Marc Messerschmidt joined the Control and Analysis Software (CAS) group, where he works closely with the SPB/SFX group. He is on secondment from the National Science Foundation BioXFEL Science and Technology Center in Buffalo, New York, and brings expertise in crystallography, data analysis, and X-ray free-electron laser (FEL) experiments.

Also new is Masoud Mehrjoo, a University of Hamburg Ph.D. student via the Center for Ultrafast Imaging (CUI). He will work on methods of X-ray FEL beam characterization that may be necessary, or at least important, for imaging non-crystalline particles with X-ray FELs.

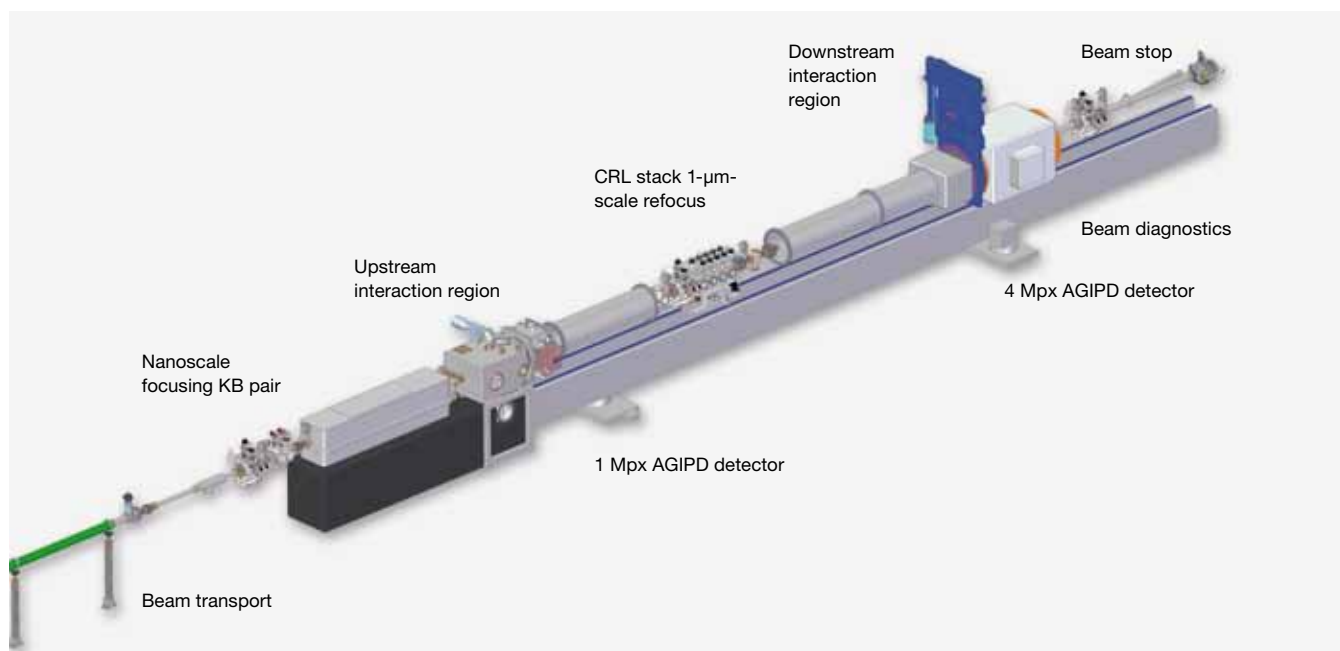

Figure 1 Overview of the key components of the SPB/SFX instrument in the experiment hutch (KB = Kirkpatrick–Baez)

In 2014, the SPB/SFX group made major progress incorporating the requirements of the SFX user consortium into the overall instrument design. In April, the group successfully presented the design overview of the apparatus contributed by the SFX user consortium for external review by the SFX technical board.

Richard Bean joined the SPB/SFX group in October to fill the responsibilities formerly addressed by Andrew Aquila, who took up a position at the Coherent X-Ray Imaging (CXI) instrument, the equivalent of the SPB/SFX instrument at the Linac Coherent Light Source (LCLS) at SLAC National Accelerator Laboratory in Menlo Park, California. Bean is an experimental physicist with significant hands-on experience at other FEL facilities, such as LCLS and the FLASH facility at DESY. He will be responsible for the SPB/SFX mirrors, among other key roles.

Integrating the SFX instrumentation into SPB/SFX

In 2014, the SPB/SFX group made major progress incorporating the requirements of the SFX UC into the overall instrument design. In April 2014, the group successfully presented the design overview of the apparatus contributed by the SFX UC (Figure 1) for external review by the SFX technical board, which is composed of local and international experts in structural biology and X-ray instrumentation.

The design report then served as a blueprint for the next steps of the instrument design in the remainder of 2014, including the design of the compound refractive lens (CRL) refocusing system, downstream instrument supports (collectively called the SPB/SFX “rail”), sample delivery systems, detector systems, optical laser systems, and sundry support systems. The requirements for the downstream 4 Mpx Adaptive Gain Integrating Pixel Detector (AGIPD) system were studied in detail and documented, based on today’s understanding of X-ray FEL crystallography. Subsequent work on detector integration is now possible.

On the optics side, the primary beam focusing system of the SPB/SFX instrument was successfully tendered. The refocusing lens system of the SFX apparatus was designed and studied for a variety of use cases, including accounting for the experimental realities of an X-ray FEL beam, such as polychromaticity, modes of operation, and more.

Exploring the limits of single-particle imaging

The SPB/SFX group continued to explore the experimental and ideal limits of single-particle imaging both through a series of experiments and through modelling. Measurements were performed on well-controlled, nanofabricated model single particles at the Advanced Photon Source (APS) of Argonne National Laboratory (ANL) in Argonne, Illinois, and the European Synchrotron Radiation Facility (ESRF) in Grenoble, France. Analysis of these data is ongoing.

On the modelling and simulation front, the group’s Hamburg-centred collaboration working on source-to-experiment modelling (simS2E) [1] of single-particle X-ray FEL experiments has further progressed to a well-defined workflow, which allows the physics of such an experiment to be modelled from the undulator source through the X-ray optics all the way to analysis, without neglecting physics such as the radiation damage that occurs to the sample when an X-ray FEL pulse interacts with a single biomolecule. This workflow can then be used for systematic studies of the limits of single-particle imaging.

A number of publications were produced in 2014, with more in progress for 2015 as the SPB/SFX group continues to analyse data and perform experiments designed to elucidate the limits and possibilities of the future SPB/SFX instrument. Group member Klaus Giewekemeyer and others have shown the importance of high dynamic range detectors to coherent imaging experiments (Figure 2) [2] by exploiting the very high dynamic range mixed-mode pixel array detector (MM-PAD) for high-resolution measurements. The team continues to probe the practical limits of X-ray coherent diffractive imaging through experimental and theoretical work.

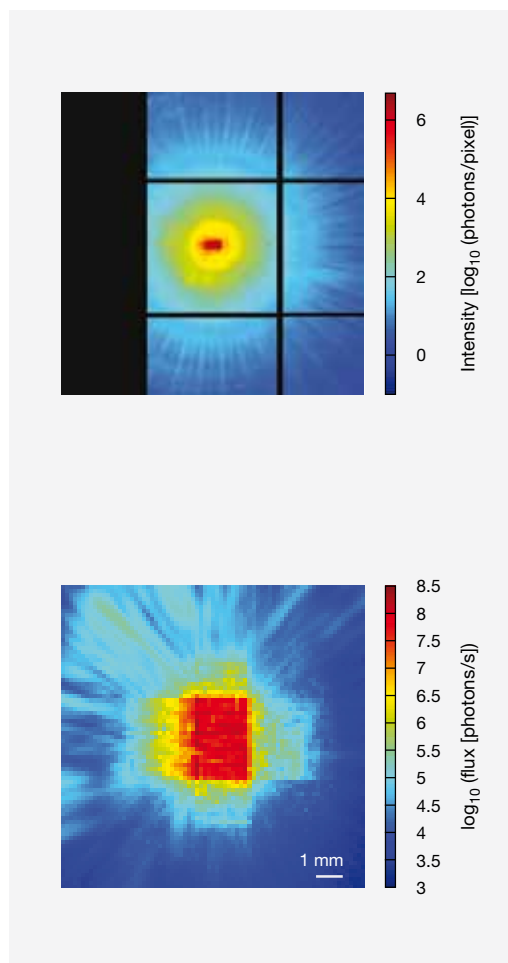

Figure 2 Diffraction data collected with the MM-PAD as described in [2].

Top Mean far-field measurement of diffraction data with sample. Note the large dynamic range exhibited by the MM-PAD.

Bottom Central region of a KB far field measured without sample and without any attenuators for an illumination time of 0.1 s. The maximum flux per pixel is 2.0×10^8 photons/s. The extremely large dynamic range of the detector is even more evident in this sample- and attenuator-free frame.

Outlook for 2015

With the beginning of user operation quickly approaching, the ordering and tendering for most of the key SPB/SFX instrument components will occur in 2015, as the SPB/SFX group prepares for installation and commissioning. In 2015, the technical design of the focusing mirrors of the SPB/SFX instruments will be finalized, and manufacturing will commence.

On the research front, the group will continue to explore the limits of X-ray FEL imaging, both experimentally with measurements at X-ray FELs and synchrotrons and theoretically with highly systematic simulation studies using the group's simS2E source-to-experiment modelling workflow. The group will also further its activities in exploring real-time, shot-to-shot beam (wavefront) characterization methods with FEL and synchrotron measurements and carry out systematic studies of competing techniques. ■

References

[1] Source-to-experiment XFEL simulation (simS2E)

C.H. Yoon, Z. Jurek, L. Samoylova, A. Buzmakov, M.V. Yurkov, E.A. Schneidmiller, B. Ziaja, R. Santra, T. Tschentscher, N.D. Loh, A.P. Mancuso
www.xfel.eu/sims2e

[2] High-dynamic-range coherent diffractive imaging: ptychography using the mixed-mode pixel array detector

K. Giewekemeyer, H.T. Philipp, R.N. Wilke, A. Aquila, M. Osterhoff, M.W. Tate, K.S. Shanks, A.V. Zozulya, T. Salditt, S.M. Gruner, A.P. Mancuso
J. Synchrotron Rad. **21**,1–8 (2014)
 doi:10.1107/S1600577514013411

Group members

(left to right) Klaus Giewekemeyer, Stephan Stern (supported by SFX project, DESY), Patrick Vagovič (supported by SFX project, DESY), Tokushi Sato (supported by SFX project, DESY), Steffen Raabe (supported by SFX project, DESY), Nadja Reimers (jointly with Central Instruments Engineering), Richard Bean (since October 2014), Adrian P. Mancuso (group leader), Gannon Borchers, Marc Messerschmidt (from CAS group), Chunhong Yoon (jointly with CFEL, DESY), Andrew Aquila (until October 2014, not shown), and Masoud Mehrjoo (student, CUI, University of Hamburg, not shown)



SCIENTIFIC INSTRUMENT SQS

In 2014, the Small Quantum Systems (SQS) instrument group worked out the details of the layout of the experiment area and the required infrastructure of the SQS instrument. The group also optimized and finalized the design of various components of the experiment chambers for the study of atomic-like quantum systems (AQS) and nano-size quantum systems (NQS). The research activities of the SQS group—mainly related to investigations of non-linear processes in prototype atomic samples and to applications of two-colour experiments for studying atomic and molecular photoionization dynamics—are based on experiments performed at other free-electron laser (FEL) sources.

Construction of the SQS instrument

A large fraction of the work undertaken by the SQS group in 2014 was related to completing the layout of the entire experiment area assigned to the SQS instrument, including the SQS experiment and laser rooms as well as the rooms dedicated to experiment control and to the accommodation of the electronic racks. The specific requirements for temperature stability, air conditioning, and media supply were analysed, and scenarios for integrating the corresponding equipment into the layout of the rooms were elaborated.

Special attention was given to optimizing the performance of the following components:

■ KB focusing optics

The focusing optics for the SQS instrument consist of a pair of extremely long (about 80 cm), bendable high-quality mirrors mounted in a Kirkpatrick–Baez (KB) configuration. Simulations of the optical beam transport were performed in order to define (i) the optimal incidence angle (9 mrad), assuring high transmission over the full range of available photon energies in the extreme ultraviolet (XUV), 270–3000 eV; (ii) the range of bending radii for both mirrors (vertical 600–1100 m, horizontal 400–850 m), assuring the variation of the focus size and enabling the focus to be moved to one of the two interaction areas; (iii) the required surface quality of the mirrors (better than 100 nrad) in order to achieve tight focusing (about 1 μm) in the first interaction area.

■ Differential-pumping unit

This specially designed section connects the vacuum vessel for the KB focusing optics and the first experiment chamber. It enables the maintenance of the extremely low pressure (better than 10^{-11} mbar) required, in particular, for coincidence measurements on single molecules, as foreseen with the chamber containing the SQS reaction microscope (REMI). Integrating the in-coupling system for the optical



Figure 1 Sketch of the AQS experiment chamber showing the first interaction area, which is surrounded by one VMI and five HReTOF spectrometers

laser and a beam position monitor in this short section (90 cm) is the main challenge for the design.

■ VMI spectrometer

For measurements of the angular distribution of electrons created during a photoionization process as well as of ions produced upon photoinduced fragmentation of a molecule, a velocity map imaging (VMI) spectrometer was designed. To enable high spectral resolution ($E/\Delta E = 10^2$ for kinetic energies up to 500 eV) while maintaining high angular resolution, a new layout based on a segmented parabolic repeller was elaborated. In particular, the small dimension of this new device facilitates the integration of the VMI spectrometer into the AQS chamber in combination with a set of high-resolution electron time-of-flight (HReTOF) spectrometers (Figure 1).

■ HReTOF spectrometer

The specific arrangement and geometrical shape of the HReTOF spectrometers ($E/\Delta E = 10^4$) will be used for performing coincidence experiments between electrons of different kinetic energies and/or electrons emitted under different angles. In addition, the combination with the VMI spectrometer will enable coincidences between electrons and ions to be measured. Two of the HReTOF spectrometers are mounted in the plane perpendicular to the beam propagation axis. They provide information about the importance of so-called non-dipole effects in non-linear processes, which will be studied at the SQS instrument.

Experiments at FERMI

The research activities of the SQS group were related principally to experiments performed at the Free Electron Laser for Multidisciplinary

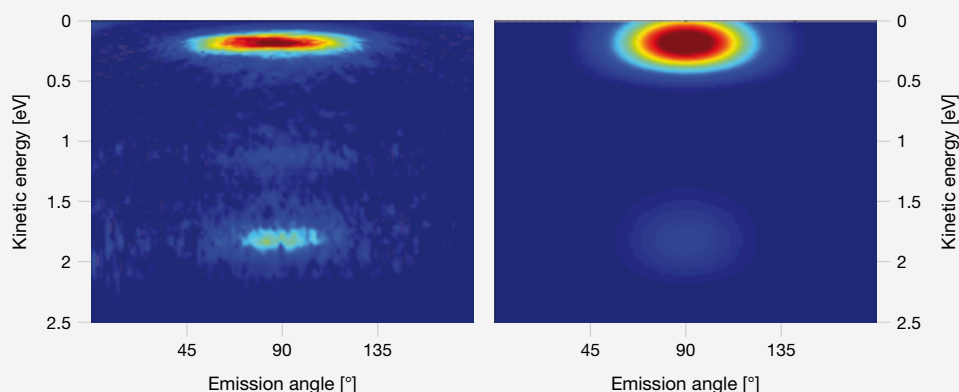

Figure 2 Experimental (left) and theoretical (right) angular distribution patterns of electron lines produced by the overlap of the XUV and NIR laser pulses, which are both left-handed circularly polarized. The two distinct features observed at 0.3 eV and 1.8 eV kinetic energy exhibit very different angular distributions when changing the relative orientation of the circularly polarized photon pulses.

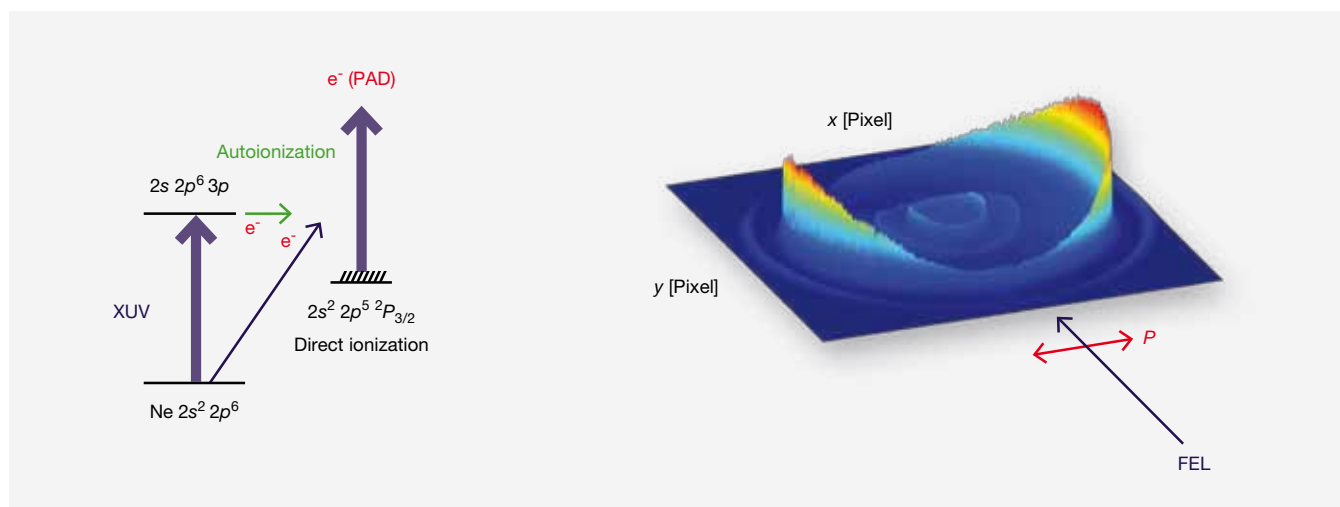

Figure 3 Influence of the resonant 2s–3p excitation in atomic neon on the angular distribution in the second ionization step.

Left Excitation scheme for the sequential ionization of atomic neon via the 2s–3p autoionizing resonance in the neutral atom.

PAD = photon angular distribution.

Right Raw 2D image of the VMI spectrometer showing the projected electron distribution upon photoionization of atomic neon in the region of the Ne 2s–3p resonance with linearly polarized FEL photons at $h\nu = 45.5$ eV. The outer circle represents the ionization in the 2p shell of the neutral neon atom, the two inner circles the ionization in the 2p shell of the Ne ion towards the $\text{Ne}^{2+} 2p^4 \ ^1D$ and $\ ^3P$ final state, respectively. The red arrow (P) indicates the direction of the electric field vector of the linearly polarized FEL radiation.

Investigations (FERMI) at Elettra Sincrotrone Trieste in Italy. The performance of this seeded FEL is ideally suited for studies of dichroic phenomena in two-colour photoionization [1] as well as for investigations of non-linear resonant excitations [2].

In one of the experimental campaigns at FERMI, the high intensity and high temporal stability of the seeded FEL was used in the two-colour ionization of atoms employing circularly polarized extreme-ultraviolet (XUV) and near-infrared (NIR) radiation. By measuring the angular distribution of photoelectrons in the low kinetic energy region using a VMI spectrometer, it was possible to identify (using the kinetic energy) and to characterize (using the electron angular distribution) a resonant excitation in the atomic ion produced in the sequence of multiple ionization by the XUV pulses (Figure 2). Multiphoton ionization of this intermediate resonance by the NIR pulses gives rise to strong circular dichroism in the angular distribution, in good agreement with the accompanying theoretical analysis. The present study of atomic helium is ideal for this comparison, since the He^+ ion with only one remaining electron can be treated perfectly by theory.

A second campaign took advantage of the high intensity and the wavelength tunability of FERMI to study the influence of resonances on the sequential ionization process. Using the VMI spectrometer for the electron analysis, the role of the resonant 2s–3p excitation in atomic neon was investigated, in particular the influence of this resonance in the neutral atom on the angular distribution in the

second ionization step, that is, the ionization of Ne^+ ions (Figure 3). The strong competition between direct and resonant ionization, which gives rise to a strongly asymmetric Fano profile for the $2s\text{--}3p$ resonance, causes variations in the alignment of the ionic ground state ($\text{Ne}^+ 2s^2 2p^5$), which can be monitored through the sequential ionization induced by the same XUV pulse. This experiment on atomic Ne is an example of a new type of measurements possible with intense FEL pulses. In the photoionization process, it enables the probing of not only the outgoing electron through electron spectroscopy in the linear regime, but also of the remaining photoion through electron spectroscopy in the non-linear regime, in this case the sequential ionization.

Perspectives for 2015

In 2015, the SQS group will define the final layout of the vacuum and alignment structure for the AQS and NQS chambers as well as the layout of the experiment-related beam diagnostics. In addition, prototypes of the HReTOF and VMI spectrometers will be produced and tested with respect to their performance and to their integration into the European XFEL control system, Karabo. The research activities at other FEL sources, such as FLASH at Deutsches Elektronen-Synchrotron (DESY) in Hamburg, Germany, FERMI, and Linac Coherent Light Source (LCLS) at SLAC National Acceleratory Laboratory in Menlo Park, California, will continue, focusing on the study of the angular distributions in the non-linear regime and on non-dipole effects in one- and two-photon ionization processes. ■

References

[1] Determining the polarization state of an extreme ultraviolet free-electron laser beam using atomic circular dichroism

T. Mazza, M. Ilchen, A.J. Rafipoor, C. Callegari, P. Finetti, O. Plekan, K.C. Prince, R. Richter, M. Danailov, A. Demidovich, G. De Ninno, C. Grazioli, R. Ivanov, N. Mahne, L. Raimondi, C. Svetina, L. Avaldi, P. Bolognesi, M. Coreno, P. O’Keeffe, M. Di Fraia, M. Devetta, Y. Ovcharenko, Th. Möller, V. Lyamayev, F. Stienkemeier, S. Düsterer, K. Ueda, J.T. Costello, A.K. Kazansky, N.M. Kabachnik, M. Meyer
Nature Communications **5**, 4648 (2014)
doi:10.1038/ncomms4648

[2] High Resolution Multiphoton Spectroscopy by a Tunable Free-Electron-Laser Light

M. Zitnik, A. Mihelic, K. Bucar, M. Kavcic, J.-E. Rubensson, M. Svanquist, J. Söderström, R. Feifel, C. Sathe, Y. Ovcharenko, V. Lyamayev, T. Mazza, M. Meyer, M. Simon, L. Journal, J. Lüning, O. Plekan, M. Coreno, M. Devetta, M. Di Fraia, P. Finetti, R. Richter, C. Grazioli, K.C. Prince, C. Callegari
Phys. Rev. Lett. **113**, 193201 (2014)
doi:10.1103/PhysRevLett.113.193201

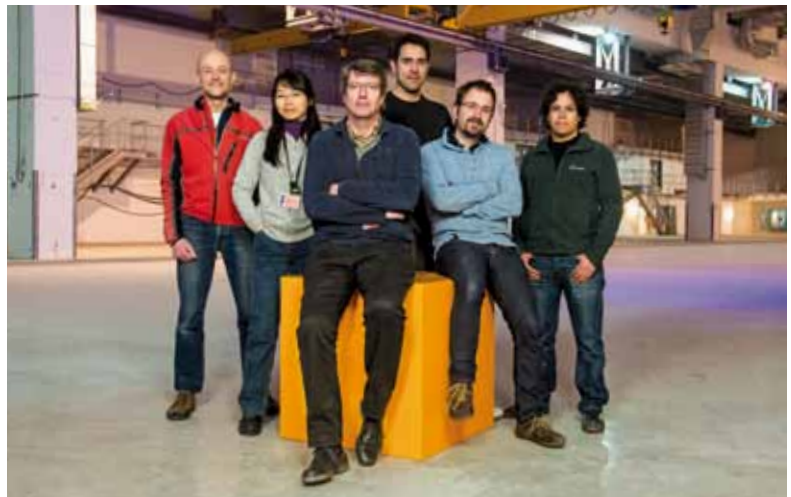

Group members

(left to right) Alberto De Fanis, Haiou Zhang, Michael Meyer (group leader), Amir Jones Rafipoor (student), Tommaso Mazza, Alexander Achner (since February 2015), Sadegh Bakhtiarzadeh (student, not shown), Markus Ilchen (postdoc at LCLS, not shown), and Nikolay Kabachnik (guest, not shown)

OPTICAL LASERS

The Optical Lasers group will provide laser equipment for pump–probe and other experiments at the European XFEL. This equipment is being developed in house and in close collaboration with industrial partners. In 2014, the group made major progress in the control integration of the pump–probe laser and the characterization of the high-power burst mode amplifier prototypes, which will allow the final engineering of the production systems.

Optical lasers at European XFEL

In addition to continuing experimental R&D and engineering work on the pump–probe laser, the Optical Lasers group intensified its cooperation with all the scientific instrument groups to develop schemes for laser beam delivery to the experiments. Procurement for the pump–probe laser production systems was started, as was the planning of the laser installations. Together with the High Energy Density Science (HED) instrument group, the Optical Lasers group continued to plan the integration of a 100 TW laser and a 100 J laser.

The joint European XFEL and Deutsches Elektronen-Synchrotron (DESY) Laser Advisory Committee (LAC) convened in September 2014, explicitly endorsing the efforts and progress of the Optical Lasers group.

Pump–probe laser development and implementation

At the heart of the European XFEL pump–probe laser is a non-collinear optical parametric amplifier (NOPA) that enables the generation of the very short pulses required for many experiments. To match the emission pattern of the X-ray source, the laser needs to be capable of burst operation with an intra-burst pulse rate of up to 4.5 MHz. Lasers satisfying these requirements are not commercially available, which is why the Optical Lasers group started to develop a prototype system in 2011. In 2013, through a number of proof-of-principle experiments, the group succeeded in demonstrating all the optical goals set for the pump–probe laser development, with the exception of the ultimate pulse energy [1,2]. During the year, the group also upgraded the NOPA pump power from 400 W to 5 kW. Even further scaling towards a pump power of 20 kW is planned. This upgrade requires additional investigations performed in collaboration with an industrial partner. With the installation and characterization of these high-power booster prototypes, the NOPA pulse energies can now be scaled up by one order of magnitude, reaching the requested millijoule level at 15 fs pulse width. Production engineering of the NOPA pump amplifiers has started.

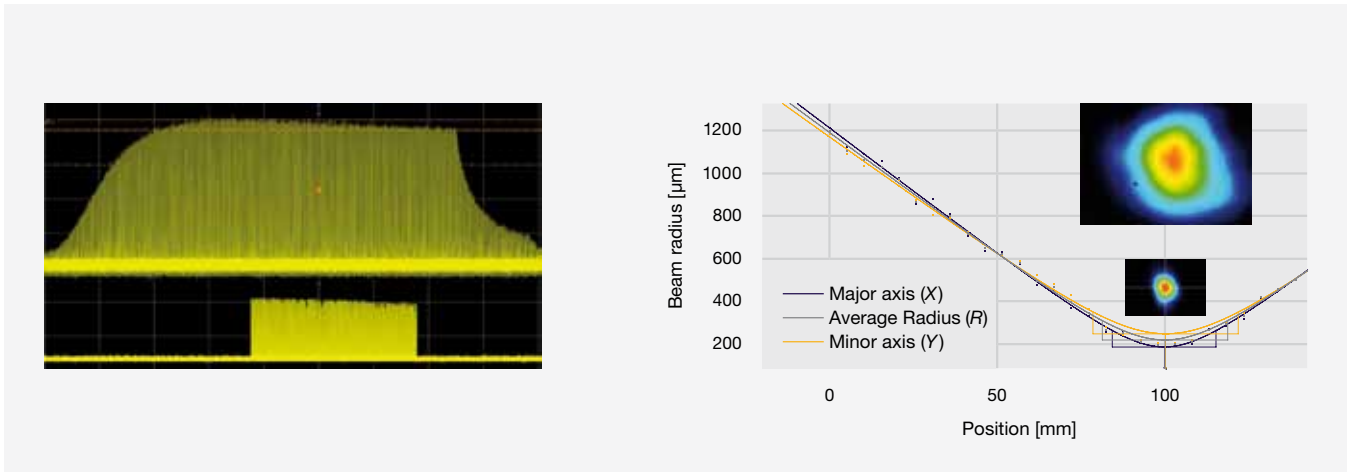

Figure 1 NOPA pump amplifier characteristics.

Left Burst after amplification and after picking the pulses to match the European XFEL–specific 600 μs burst length.

Right Caustic measurement showing the beam radius around the focus of nearly diffraction-limited 1030 nm beam. Near-field (top) and far-field (bottom) beam profiles.

The pump–probe laser system requires monitoring and control integration into the in-house control system Karabo, with which most of the required control and monitoring hardware was installed, integrated, and tested.



Figure 2 Control cabinet of the pump–probe laser

The left side of Figure 1 shows the burst of the 5 kW NOPA pump amplifier beam as recorded after amplification and after selecting (“picking”) the pulses to match the European XFEL–specific burst length of 600 μs . The right side of Figure 1 displays the caustic—the measured evolution of the beam radius along the propagation direction—together with beam shapes in the far and near field after circularization and filtering. All depicted measurements were done at an intra-burst repetition rate of 1 MHz. The close-to-diffraction-limited beam quality assures optimal conditions for the amplification of ultrashort pulses in the NOPA, equal to those already demonstrated under 400 W pumping conditions [1,2].

The pump–probe laser system requires monitoring and control integration of all its subsystems into the European XFEL control system Karabo. This control system is being developed by the Control and Analysis Software group, with which the Optical Lasers group established a close and intensive collaboration in 2014. Most of the control and monitoring hardware required for the pump–probe laser, including the laser timing system, was installed, integrated, and tested with Karabo. Further tests and debugging with subsequent releases of the control software are needed to ensure robust performance during user operation. Figure 2 shows the control cabinet of the European XFEL pump–probe laser prototype installation.

For the operation phase, one pump–probe laser will be installed at each of the three experiment areas (SASE1, SASE2, and SASE3). To facilitate a smooth installation process, which will begin in April 2016 with SASE1, the Optical Lasers group invested considerable effort in the following areas in 2014:

- Detailed computer-aided design (CAD) integration of the complete pump–probe laser system for SASE1 was advanced, with expected completion in 2015.
- Procurement of all long lead–time subsystems was started.
- Infrastructure and implementation planning for the SASE1 laser room was finalized.

In close collaboration with the HED group, provisions were made for a 100 TW laser and a 100 J–class nanosecond laser.



Figure 3 Group members working in the European XFEL laser lab

Further activities

In parallel to working on pump–probe laser development, the Optical Lasers group continued to plan the laser integration at the HED instrument at SASE2. In close collaboration with the HED group, provisions were made for a 100 TW laser and a 100 J–class nanosecond laser (DiPOLE 100-X), both of which are contributions proposed by the Helmholtz International Beamline for Extreme Fields at the European XFEL (HIBEF) user consortium. Progress was made with the laser room and beam delivery layout. In particular, the DiPOLE 100-X laser project was started along with detailed discussions on the facility integration of this laser, which is being built at the Central Laser Facility of Rutherford Appleton Laboratory in Didcot, UK, for the HIBEF user consortium.

Outlook for 2015

Major tasks for the Optical Lasers group in 2015 include:

- Finalization of all proof-of-principle experiments, including the high-power and high-energy multistage NOPA, required for the pump–probe laser R&D
- Ongoing testing and detailing of the Karabo integration of the pump–probe laser
- Ongoing CAD integration of the pump–probe laser production systems
- Ongoing planning of the 100 TW and 100 J laser integration in cooperation with the HED instrument group and the HIBEF user consortium
- Ongoing procurement of all components and subsystems for three pump–probe laser production systems to be installed in the experiment hall ■

References**[1] Burst-mode Femtosecond Non-collinear Parametric Amplifier with Arbitrary Pulse Selection**

M. Pergament, M. Kellert, K. Kruse, J. Wang, G. Palmer, L. Wissmann, U. Wegner, M.J. Lederer

CLEO: 2014 Science and Innovations (CLEO_SI), 8–13 June 2014, San Jose California, USA, STh4E.4, OSA Technical Digest

ISBN: 978-1-55752-999-2

doi:10.1364/CLEO_SI.2014.STh4E.4

[2] High power burst-mode optical parametric amplifier with arbitrary pulse selection

M. Pergament, M. Kellert, K. Kruse, J. Wang, G. Palmer, L. Wissmann, U. Wegner, M.J. Lederer

Optics Express **22** (18), 22202–22210 (2014)

doi:10.1364/OE.22.022202

**Group members**

(left to right) Guido Palmer, Laurens Wißmann, Martin Kellert, Moritz Emons, Max Lederer (group leader), Kai Kruse, Gerd Priebe, Jinxiong Wang, Ulrike Wegner, and Mikhail Pergament

SAMPLE ENVIRONMENT

The Sample Environment group develops state-of-the-art sample environment systems for the scientific instruments, and plans and prepares the user laboratories at the European XFEL headquarters. Together with internal and external partners, the group operates a test facility for liquid jets and builds test experiments for a fast sample changer and compact pulsed magnets.

Preparing contributions to the scientific instruments

In 2014, the Sample Environment group reached the full personnel strength for the construction phase of the European XFEL. The four areas of competence—biology, gases and liquids, solid targets, and magnetic fields—were established, and deliveries for the first instruments were defined.

The planning of the user laboratories was finalized. Plans for integrated user support in the laboratories managed by European XFEL and for the add-ons contributed by user consortia were developed in coordination with the instrument groups, the Safety and Radiation Protection group, and the User Office.

The group is developing a fast sample scanner for high repetition rate measurements of solids, surfaces, and targets that can be mounted on holders. The goal is to move a sample by about a millimetre within a tenth of a second and position it with micrometre accuracy. The design of a prototype for the SCS instrument is nearly finished.

Fast sample scanner and magnets

The Sample Environment group is developing a fast sample scanner for high repetition rate measurements of solids, surfaces, and targets that can be mounted on holders. The goal is to move a sample by about a millimetre within a tenth of a second and position it with micrometre accuracy. The design of a prototype for the Spectroscopy and Coherent Scattering (SCS) instrument is nearly finished, and the device will be ready for production at the beginning of 2015. As a soft X-ray instrument for surface science, SCS has the highest demands on vacuum compatibility of all the European XFEL instruments, which is the reason the Sample Environment group chose it for designing the prototype. Versions for other instruments are planned.

The Sample Environment group also restarted a project to provide magnetic fields for the scientific instruments. In January and February 2014, Oleksiy Drachenko was a scientist in the group and developed



Figure 1 Cross-section of compact coils for millisecond-long magnetic pulses developed by Peter van der Linden at ESRF. The Sample Environment group will test similar electromagnets to destruction to prove their suitability for the scientific instruments.

a concept for pulsed compact magnets with field strengths up to 30 T. The time structure of the magnetic pulses will fit the bunch train length of the European XFEL. In May 2014, James Moore took over the magnet project and started collaborations with leading high magnetic field laboratories in Europe. The Sample Environment group developed a concept to provide compact magnets for the soft X-ray SCS and the hard X-ray Materials Imaging and Dynamics (MID) and High Energy Density Science (HED) instruments. First test coils were wound at the European Synchrotron Radiation Facility (ESRF) in Grenoble, France (Figure 1). The terms of collaboration with the Helmholtz International Beamline for Extreme Fields at the European XFEL (HIBEF) user consortium, which will deliver strong pulsed magnets for the HED instrument, were agreed on.

Biological targets for FELs

Preparation of biological targets for the European XFEL is one of the areas of competence of the Sample Environment group. Through March 2014, Charlotte Uetrecht was planning the biological laboratories in coordination with the Integrated Biology Infrastructure Life-Science Facility at the European XFEL (XBI) user consortium. With the help of a grant from the PIER Ideenfond, a competitive funding scheme in the frame of collaboration between the University of Hamburg and large research infrastructures in the Hamburg area, the group purchased a mass spectrometer to develop mass spectrometry as a sample preparation method for X-ray FELs. In April 2014, Uetrecht started a junior group at Heinrich Pette Institute (HPI) at the University of Hamburg, but she continues the mass spectrometry project as a guest scientist in the Sample Environment group.

In 2014, the Sample Environment group reached the full personnel strength for the construction phase of the European XFEL. The four areas of competence—biology, gases and liquids, solid targets, and magnetic fields—were established, and deliveries for the first instruments were defined.

In September 2014, Kristina Lorenzen started as a biologist in the Sample Environment group. Drawing on her expertise, the group drafted a scheme for integrating biology laboratories in the general user support of European XFEL. Lorenzen also prepared the purchase of a high-performance liquid chromatography (HPLC)–based system for the delivery of biological samples in liquids.

In collaboration with the groups of Ronnie Hoekstra at the University of Groningen, the Netherlands, and Tobias Lau at Helmholtz-Zentrum Berlin für Materialien und Energie (HZB), Germany, Sadia Bari

Figure 2 Photodissociation of the protein melittin illuminated by left- and right-handed circularly polarized X-rays from BESSY II. The figure shows the ion yield for two different fractions of the molecule (Group 2 and Group 5). The ion yield of Group 5 is stronger for left-handed helicity of the X-ray beam. This dichroism can give valuable additional information about the dissociation process. Further evaluation of the data is ongoing.

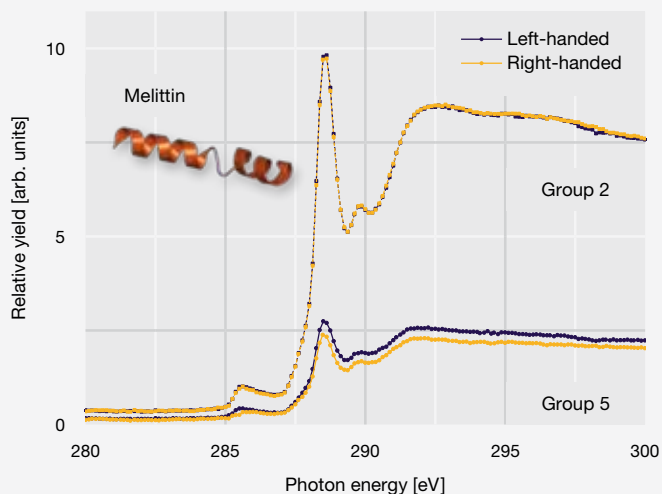

investigated photodissociation of the protein melittin, an ingredient of bee venom, at the BESSY II synchrotron radiation source at HZB (Figure 2). The protein was introduced into the beamline by means of an electrospray source. This method is a candidate for an effective sample delivery scheme for studying charged proteins at the European XFEL.

Outlook for 2015

In 2015, the Sample Environment group will focus on building and testing prototypes of the sample delivery systems for the scientific instruments. In the fields of biology and liquid-sample systems, the focus will be on a sample preparation and delivery system for the Single Particles, Clusters, and Biomolecules and Serial Femtosecond Crystallography (SPB/SFX) instrument. In the field of fixed targets, the design of the fast sample scanner prototype for the SCS instrument will be finalized, and production of the prototype will be started. An adaption of the ultrahigh-vacuum setup for SCS to the hard X-ray instruments with lower vacuum demands will follow.

The Sample Environment group is also responsible for helping users prepare their samples in the European XFEL user laboratories. In 2015, the group will work out plans to integrate this support in the general user support strategy. To this end, interaction with in-house groups as well as with the user consortia XBI, SFX, and HIBEF will be intensified. The Sample Environment group will coordinate the sample delivery-related parts of these user consortia. ■



Group members

(left to right) Sadia Bari, Carsten Deiter, Charlotte Uetrecht (guest), Joachim Schulz (group leader), Kristina Lorenzen, Matthäus Kitel, Elisa Delmas, James Moore, Oleksiy Drachenko (until February 2014, not shown), and Jesse Spencer (guest student, not shown)

CENTRAL INSTRUMENTS ENGINEERING

The Central Instruments Engineering (CIE) team supports the six scientific instruments of the European XFEL by coordinating and facilitating engineering projects common to two or more of the instruments and by performing specific tasks. In particular, the team aims to standardize common engineering processes.

Main activities

In 2014, the CIE team defined specifications and developed design concepts for critical devices, such as beam stops, alignment laser systems, and soft X-ray slits. The vacuum interface between the photon distribution tunnels and the experiment hall was precisely modelled, and vacuum carts essential for beamline commissioning were selected in preparation for ordering in 2015.

The design of the SASE1 hutches and infrastructure was completed, in cooperation with WTM Engineers in Hamburg, Germany, and DERU Planungsgesellschaft für Energie-, Reinraum- und Umwelttechnik mbH in Dresden, Germany, and under the coordination of the Photon Systems Project Office (PSPO). This provided the foundation for the corresponding calls for tender.

The CIE team coordinated the Danish in-kind contribution DK02, “Components for the Scientific Instruments FXE, SPB, MID, and HED”, by Technical University of Denmark (DTU) in Lyngby, which was ready for prototype manufacture. The team also supported the electrical implementation of another Danish in-kind contribution, DK01, “FXE Instrumentation”, also by DTU.

The CIE team standardized a method for documenting instrument vacuum systems, media distribution systems, electrical connections, and cabling.

A suite of versatile finite element analysis (FEA) models developed by the CIE team has significantly increased the understanding of the heat loads foreseen on components illuminated by the European XFEL beam. This has led to clear definitions of safe operating conditions at the beam stops and other components.

The ePlan software, which is essential for electrical planning, was successfully rolled out across the company and integrated into forthcoming electrical projects. In late 2014, several European XFEL work packages began to use ePlan in order to facilitate the design, documentation, and procurement of components. ePlan will become the basis for the generation of all control firmware, reducing the design and production time while, at the same time, unifying European XFEL

processes and incorporating European Union standards for naming conventions throughout the company.

In addition, the CIE team improved the information exchange between the instrument engineers and developed a forum for knowledge exchange.

Outlook for 2015

In 2015, the CIE team will continue to work closely with the instruments groups, developing detailed design concepts for devices, hutches, instrument vacuum systems, and media distribution systems. The team will develop the infrastructure and processes necessary to test and commission a variety of prototypes expected for delivery this year. Using ePlan, cable production and procurement tasks will be further optimized. In addition, the CIE team will support the procurement and manufacturing of further components and provide engineering expertise for specific tasks. ■

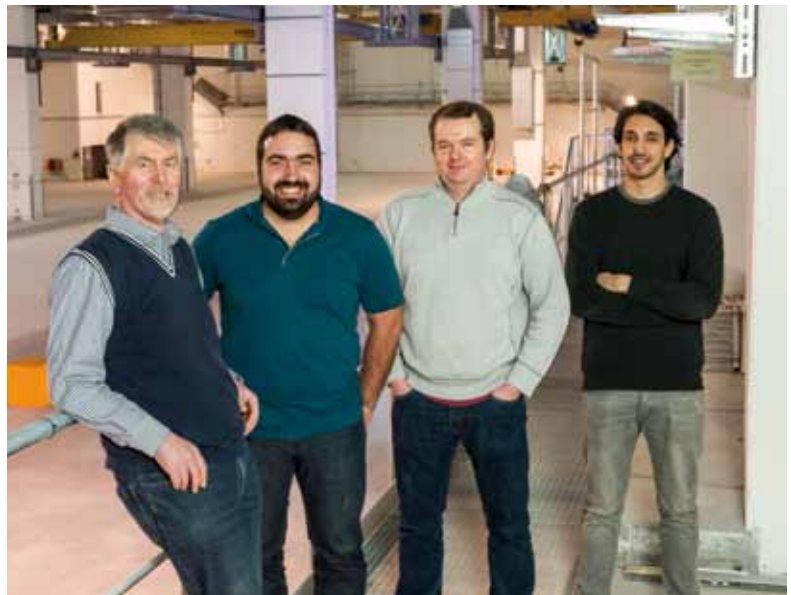

Group members

(left to right) Wolfgang Tscheu (team leader), Antonios Lalechos, Lewis Batchelor, Osama Salem, Christian Dauer (intern until September 2014, not shown), Viktor Lyamayev (not shown), and Nadja Reimers (not shown)

07

DETECTORS AND DATA ACQUISITION

The first detector setup was successfully tested in 2014. Following a restructuring, three groups in charge of data acquisition and control systems focused on managing the incoming deluge of information and setting up high-precision controls.

Assembling the Large Pixel Detector in the cleanroom





DETECTOR DEVELOPMENT

In collaboration with national and international partners, the Detector Development group at European XFEL develops high-speed large- and small-area X-ray detectors required by photon experiments for imaging, monitoring, veto, and spectroscopic applications. In preparation for the operation phase, the group expanded to almost full size.

Changing group structure

In 2014, the group grew significantly to nearly its planned size. Philipp Lang took over coordination, commissioning, and testing activities of the Large Pixel Detector (LPD) project. Two additional detector scientists—Astrid Münnich and Friederike Januschek—will strengthen the capabilities of the group in terms of detector-related user support during the operation phase of the facility. Alexander Kaukher is working closely with the scientific groups on the implementation and development of veto detectors and concepts. Master student Tonn Rüter supports the detector performance simulation and software development activities of the group. Filip Kasnar and Melanie Eich successfully finished their master and bachelor studies, respectively, on performance characterization and calibration of charge-coupled device (CCD) detectors.

Working closely with the LPD collaboration, group members successfully demonstrated the single photon detection sensitivity of an LPD prototype system at the Diamond Light Source in Oxfordshire, UK.

In the context of the restructuring of the former DAQ and Control Systems group, Patrick Geßler left the Detector Development group to become the group leader of the new Advanced Electronics (AE) group. Three other former members of the Detector Development group—Frank Babies, Balakumaar Baskaran, and Kai-Erik Ballak—also joined the AE group.

Ultrafast 2D imaging detectors

In 2014, the group successfully commenced operation of the first detector calibration and test environment, and Hamburg authorities granted European XFEL a license to operate X-ray calibration sources in the detector laboratory in the HERA South building. These were major steps towards the extensive calibration and commissioning activities the group will perform in the run-up to the final implementation of the detectors at the scientific experiments in 2017.

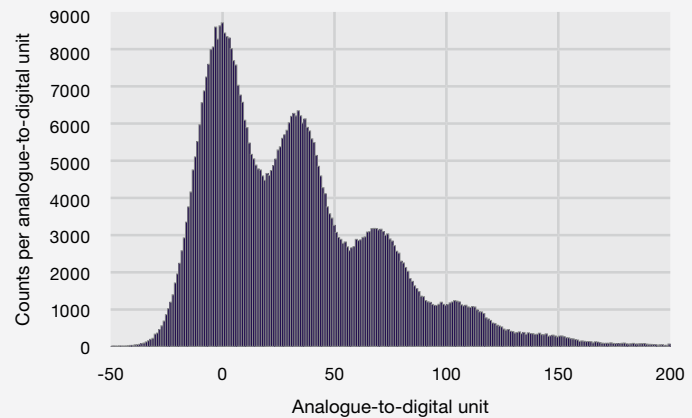
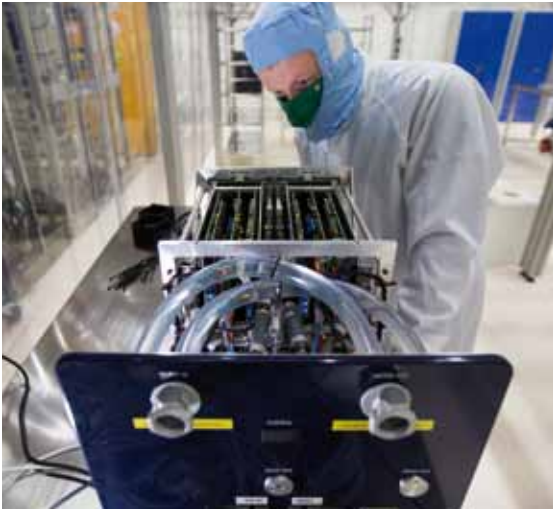

Figure 1 Ultrafast 2D imaging detectors.

Left Scientist working on the LPD prototype detector in the X-ray free-electron laser detector laboratory in the HERA South building.

Right Spectrum of events measured with an LPD prototype detector at Diamond Light Source in the UK. From left to right, the clearly separated peaks of events with zero (noise), one, two, three, and four photons are shown. The energy of one photon was 18 keV.

Working closely with the LPD collaboration, Detector Development group members successfully demonstrated the single-photon detection sensitivity of an LPD prototype detector system at the Diamond Light Source in Oxfordshire, UK (Figure 1, right). This demonstration was an important milestone, enabling the LPD collaboration to start integrating the 1 Mpx LPD system for the Femtosecond X-Ray Experiments (FXE) instrument.

After the Depleted P-Channel Field Effect Transistor (DEPFET) Sensor with Signal Compression (DSSC) collaboration was severely affected by restructuring measures during 2013, European XFEL extended the contract with the DSSC collaboration in 2014. Detector Development group members joined the DSSC collaboration and became strongly involved in the integration and commissioning process of the 1 Mpx DSSC camera. The group started to build up a laboratory environment in preparation for its new tasks.

In 2014, the Adaptive Gain Integrating Pixel Detector (AGIPD) collaboration made a big step forward, demonstrating the functionality and performance of the application-specific integrated circuit (ASIC) for the 1 Mpx detector that it received in 2013. Further in-depth performance tests of prototype detector modules successfully demonstrated that the detector can record images at a sampling rate of 4.5 MHz and beyond. The Detector Development group is looking forward to receiving the first small AGIPD prototype in 2015.

To be able to satisfy the scientific demand for strip detectors supporting the 4.5 MHz pulse repetition rate of the European XFEL,

the Detector Development group started to collaborate with Paul Scherrer Institut (PSI) in Villigen, Switzerland. The primary objective of this cooperation is to upgrade the Gotthard strip detector technology in order to comply with the requirements of the European XFEL. As a first step, scientists from PSI have improved the ASIC for the Gotthard detector, adding functionality and improving the readout speed.

Throughout 2014, the Detector Development group intensively tested prototype cameras, based on different CCD technologies, mainly suited for low-speed applications (10 Hz up to several kHz). A prototype FastCCD detector built at Lawrence Berkeley National Laboratory (LBNL) in Berkeley, California, successfully passed its performance tests, and a pnCCD detector, which was built by members of the Detector Development group in cooperation with scientists from PNSensor GmbH in Munich, Germany, detected first X-ray photons.

A pulsed X-ray tube providing X-ray flashes at a frequency of 4.5 MHz will allow the group to calibrate photon and electron detectors at low intensities at the high repetition rate of the European XFEL. After installing this X-ray source, the group will carry out in-depth in-house performance tests of prototype detectors.

Outlook for 2015

The Detector Development group will continue to put into operation and commission the detector calibration infrastructure in the detector laboratory in the HERA South building. A pulsed X-ray tube providing X-ray flashes at a frequency of 4.5 MHz will allow the group to calibrate photon and electron detectors at low intensities at the high repetition rate of the European XFEL. After installing this X-ray source, the group will carry out in-depth in-house performance tests of prototype detectors, among them a small DSSC demonstrator detector system.

Due to progress achieved in the field of multichannel plate (MCP) detectors in 2014, the Detector Development group expects delivery of a high spatial resolution MCP prototype detector in the first half of 2015. The detector built by Surface Concept GmbH in Mainz, Germany, will provide a sampling rate of 4.5 MHz. Meanwhile, PSI will receive and test the performance of the first prototype ASIC chips in 2015.

The group will continue to develop and improve user-friendly detector control and data-processing software and develop calibration and detector operation concepts for the European XFEL. ■

References

[1] Detectors and Calibration Concept for the European XFEL

M. Kuster, D. Boukhelef, M. Donato, J.S. Dambietz, S. Hauf, L. Maia, N. Raab, J. Szuba, M. Turcato, K. Wrona, C. Youngman
Synchrotron Radiation News **27** (4), 35–38 (2014)
doi:10.1080/08940886.2014.930809

Group members

(left to right) Markus Kuster (group leader), Marko Ekmedzic, Monica Turcato, Friederike Januschek, Tonn Rüter (student), Astrid Münnich, Thomas Dietze (since March 2015), Jolanta Sztuk-Dambietz, Philipp Lang, Natascha Raab, Mattia Donato, Alexander Kaukher, Sneha Nidhi, Kai-Erik Ballak (until October 2014, not shown), Balakumaar Baskaran (until October 2014, not shown), Frank Babies (until October 2014, not shown), Melanie Eich (student, until September 2014, not shown), Patrick Geßler (until October 2014, not shown), Steffen Hauf (not shown), Filip Kasnar (student, until May 2014, not shown), Stephan Schlee (student, DSSC project, not shown), Rüdiger Schmitt (not shown), and Georg Weidenspointner (DSSC project, not shown)



ADVANCED ELECTRONICS

The Advanced Electronics (AE) group is responsible for control and fast readout electronics required for automation, data acquisition, and pre-processing at photon beamlines and experiments at the European XFEL. In 2014, the group evaluated the major capabilities and performance of the developed electronics in various instrument and experiment setups at other facilities.

Group background and mandate

In October 2014, the former DAQ and Control Systems group was reorganized into three new groups: AE, IT and Data Management (ITDM), and Control and Analysis Software (CAS).

A key task of the AE group is to identify or develop modular electronic solutions that fulfil the demanding requirements of the European XFEL facility for complex control, monitoring, and real-time data acquisition. In this context, the firmware for controlling equipment and processing acquired signals has to be developed.

Successful operation of automation and control installations

Pumps, valves, sensors, motors for positioning, encoders, and shutters are only some examples of equipment that have to be monitored and controlled by programmable logic controllers (PLC) along the beamlines and at the experiments. In 2014, the group made significant progress developing the framework used to prepare firmware projects for customized combinations of equipment and control requirements.



Figure 1 The von Hamos spectrometer of the Femtosecond X-Ray Experiments (FXE) group is a fully motorized device that is controlled and monitored by the PLC system using a firmware developed in house.

In preparation for beamline and experiment installations, various groups require test setups. Since 2013, AE group members have been significantly involved in the design, manufacturing, installation, and support of control systems. Thirty such systems are now operational.

Real-time processing on fast readout electronics

Various detector devices will be used at the European XFEL. These detectors have to capture properties of individual X-ray pulses at a repetition rate of 4.5 MHz. For this purpose, hundreds of signals have to be digitized and pre-processed before the acquired data are transmitted to software processing, visualization, and storage. In almost all cases, field programmable gate arrays (FPGAs) are included in the electronics and require substantial firmware programming efforts.

In 2014, the group further developed the high-level Simulink-based framework for processing algorithms used in the prototype instruments of various groups at European XFEL. Furthermore, a first implementation of the real-time veto system was finalized and tested successfully.

Outlook for 2015

In 2015, the major activity of the AE group will be the preparation, installation, commissioning, and support of the control and acquisition electronics in the beamline tunnels, experiments, and temporary locations. The development of the frameworks will be finalized, and specialized algorithms for pre-processing will be integrated and commissioned. ■

Group members

(left to right) Bruno Fernandes, Jörn Reifschläger, Nicola Coppola, Jan Tolkiehn, Kai-Erik Ballak, Patrick Geßler (group leader), Frank Babies, Hamed Sotoudi Namin, Balakumaar Baskaran, Anto Jesudoss (student, not shown), Thorsten Keil (intern, not shown), and Auguste Youdjeu (student, not shown)



CONTROL AND ANALYSIS SOFTWARE

The Control and Analysis Software (CAS) group provides software development, support, maintenance, and expertise in the areas of beamline control and data analysis. A central task of the group is the development and maintenance of the Karabo software framework, which enables both beamline control and data analysis.

Forming a new group

In October 2014, the former DAQ and Control Systems group was reorganized into three new groups: Advanced Electronics (AE), IT and Data Management (ITDM), and CAS.

The CAS group provides software and related services for instrument and test stand (laboratory setup) control and for interactive and workflow-based data analysis. The group also coordinates former DAQ and Control Systems projects for other groups, such as ITDM, AE, and Central Instrument Engineering (CIE).

Karabo software framework

The Karabo software framework is the backbone of all software activities related to data acquisition (DAQ) and control systems. During 2014, the CAS group released two new versions of the Karabo framework (1.1 and 1.2). The group is now working on the next release planned for early 2015. Every new release reflects substantial feature and performance improvements, most visibly in the graphical user interface (GUI). At this point, users can compose expert panels in the same intuitive way one composes slides for a presentation, by simply dragging and dropping items onto the panel. The new release will even enable users to graphically compose data streaming pipelines by dragging compute nodes and connecting them with a mouse click.

Control systems

Several new in-house control system setups—comprising equipment such as turbomolecular pumps, scroll pumps, motors, valves, gauges, cameras, and so on—were installed. One important achievement was the implementation and demonstration of motion control for the Adaptive Gain Integrating Pixel Detector (AGIPD), which exceeded the specified requirements in repositioning accuracy (Figure 1). Another highlight was the relatively large installation for the Optical Lasers group, which was continuously improved and at this point implements nearly all features needed for the operation phase.



Figure 1 Test frame for the AGIPD 1 Mpx 2D detector. The four movable quadrants are visible as metallic placeholders in the centre right of the picture.

An important achievement was the implementation and demonstration of motion control for the AGIPD, which exceeded the specified requirements in repositioning accuracy. Another highlight was the installation for the Optical Lasers group, a system which at this point implements nearly all features needed for the operation phase.

Much effort went into supporting new equipment and writing software for generic use. Examples include a camera driver, using the Generic Interface for Cameras (GenICam) protocol, and a driver able to control any hardware based on Standard Commands for Programmable Instruments (SCPI).

Data analysis

In 2014, the CAS group implemented a data-processing pipeline for the Serial Femtosecond Crystallography (SFX) experiment. In collaboration with the group, Chunhong Yoon from the Single Particles, Clusters, and Biomolecules and Serial Femtosecond Crystallography (SPB/SFX) instrument group managed to divide the computationally demanding algorithms of CrystFEL into Karabo computing modules and execute them on more than 80 cores in parallel, showing an almost linear speed-up. He tested the pipeline on simulated and real data from the Linac Coherent Light Source (LCLS) in Menlo Park, California, and was able to prove the general functionality and conceptually correct design of Karabo's data streaming system.

DAQ and control project coordination

After the reorganization of the former DAQ and Control Systems group, the CAS group started to compile an overview of all upcoming and already running DAQ and control system projects. In close collaboration with ITDM, AE, and CIE, the CAS group began to prepare a new DAQ & Control site in the European XFEL document management system, Alfresco, in order to centralize all information and instructions about workflows, responsibilities, and timelines for equipping all instruments, tunnels, and laboratories.

Outlook for 2015

The most important goal of the CAS group for 2015 is to establish a streamlined workflow to handle the large amount of upcoming DAQ and control system installations. This workflow relies on continued close collaboration with the AE, CIE, and ITDM groups, both on a technical and a human level. Another challenge for the coming year is to finalize the Karabo system while simultaneously deploying, supporting, and maintaining it. ■

Group members

(left to right) Kerstin Weger, Martin Teichmann, Andreas Beckmann, Burkhard Heisen (group leader), Andrea Parenti, Gabriele Giambartolomei, Alessandro Silenzi, Sergey Esenov, and Marc Messerschmidt (guest)



IT AND DATA MANAGEMENT

The IT and Data Management (ITDM) group was established in October 2014 by combining the IT group and the Data Management team of the former DAQ and Control Systems group. The new ITDM group is responsible for providing and maintaining IT infrastructure, a wide range of IT and data management services, and IT user support.

ITDM accomplishments

In 2014, members of the ITDM group routinely delivered IT services to European XFEL staff members. The group completed the design of the IT infrastructure required for experiments at the European XFEL instruments and the network design for the SASE1 instruments. A data recording system for large pixel detectors was deployed for use with detector test installations. Developments of web applications and data management services progressed significantly.

IT support

In 2014, the ITDM group delivered and supported IT services ranging from the preparation of single user workplaces to support for dedicated engineering and scientific tools as well as commonly used services, such as the European XFEL document management system, Alfresco. The ITDM group also provided and supported computer systems for other groups, enabling them to build their test installations and to progress in their own development programmes. The procedures and workflows for setting up and supporting test installations were further optimized.

IT infrastructure

Significant progress was made in the design of the network and computer room infrastructure required for data acquisition and online data processing. In particular, the design and the detailed implementation plan for the SASE1 area—including photon beam system tunnels, dedicated computer rooms, control rooms, experiment hutches, and backbone connections to the computer centre—were completed. This infrastructure plan included details about the power distribution system, cooling infrastructure, server cabinets, network switches, patch panels, cable types, and cable routing. The first calls for tender were sent out, and purchases were initiated.



Figure 1 Servers for recording data from the $\frac{1}{4}$ Mpx detector installed in the HERA South laboratory

Data recording and management system

In 2014, the data recording prototype system developed in previous years was deployed, tested, and used with real detectors for the first time. After subsequent optimization, the ITDM group was able to achieve the required data recording throughput rate up to the disk storage layer. The system was tested with a $\frac{1}{4}$ Mpx detector prototype capable of producing data at up to 2.5 GB/s (Figure 1). The successful implementation of the entire system for the prototype detector also proved the network design principle, which is now foreseen for the final system.

The ITDM group also worked on other components required for fast data analysis and long-term data storage. The first prototype for an online computing cluster was implemented in the data centre of Deutsches Elektronen-Synchrotron (DESY) and connected to its data repository.

Development projects

In 2014, the first version of the software for handling detector calibration data was released. A repository of calibration data files and applications for catalogue management were deployed and are now being tested by detector experts. In parallel, the ITDM group has designed, purchased, and deployed a high-availability cluster for web applications and underlying databases.

Outlook for 2015

In the coming year, developments and tests of data management solutions will continue. The full data acquisition chain—including run management, interactions with the metadata catalogue, and the raw data repository—will be deployed and validated. Implementation of the full SASE1 computer infrastructure and network will follow. Detailed planning for the remaining SASE2 and SASE3 areas still needs to be completed. Large-scale procurement of data acquisition and data management servers that follow the proven network design will start towards the end of the year. ■

Group members

(left to right) Kimon Filippakopoulos (since January 2015), Krzysztof Wrona (group leader), Manfred Knaack, Jorge Elizondo, Janusz Szuba, Dawid Ziółkowski, Bartosz Poljancewicz, Mauricio Manetti, Christopher Youngman, Luís Maia, Djelloul Boukhelef (not shown), and Mayank Kumar (not shown)

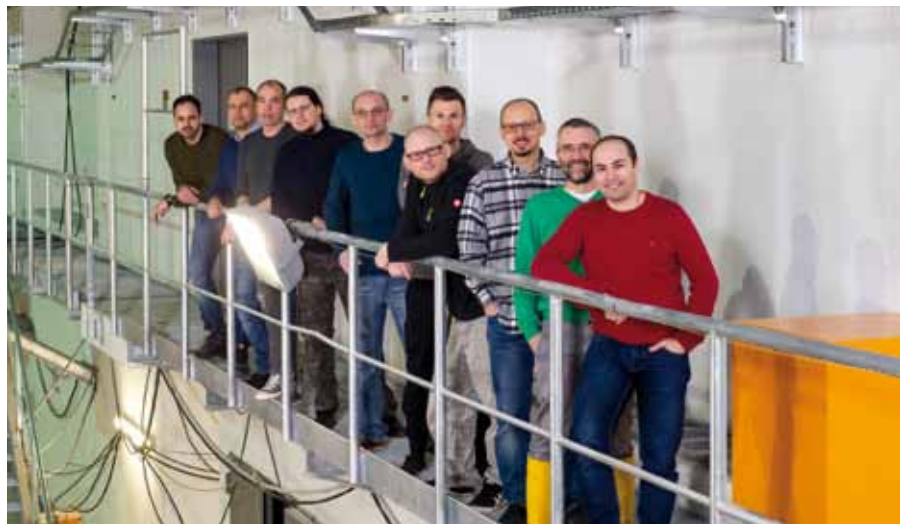

08

SERVICES

Administrative and other employees support the facility, recruit staff, communicate with the public, coordinate installations, plan technical infrastructure, conduct internal audits, ensure safety, and plan for welcoming future users.

Administrative employees at European XFEL





ADMINISTRATIVE SERVICES

The European XFEL administration fulfils an enabling role. The members of the administration provide the necessary resources for the construction of the European XFEL facility and are beginning to prepare for the start of operation. They recruit highly qualified staff from all over the world and purchase needed goods and services, from office supplies to highly sophisticated, state-of-the-art scientific equipment. They manage the company's finances, draft and implement the annual budget, run efficient cost controlling, and make sure that the company complies with all legal obligations.

Composition

Currently, the administration is composed of five groups: Finance and Controlling, Human Resources (see "Human Resources"), Legal, Procurement, and the User Office (see "User Office"). Furthermore, the knowledge management officer and the librarian are part of the administration. Altogether, the administration comprises slightly more than 20 staff members—around 10% of the total European XFEL staff.

Finance and Controlling

The financial resources of the company are managed by the Finance group. The activities include not only all financial transactions, such as the payment of invoices or salaries, but also liquidity management, based on the requirements of the project and the scheduled cash contributions by the different contracting parties funding the project. Liquid funds not immediately needed to pay invoices are invested as time deposits. The Finance group is also in charge of bookkeeping and accounting in accordance with the applicable German accounting standards. The members of the Finance group deliver the annual financial statement of European XFEL and make sure that the company correctly fulfils all tax obligations. As in previous years, external auditors issued an unconditional certification for the annual financial statement 2013.

Cost controlling of a complex project like the European XFEL with a budget of around 1.15 billion euro (in 2005 value) is a big challenge. It is a joint effort involving all groups within the company and coordinated by the Controlling group. Working at the frontier of technology means that a high level of uncertainty has to be met through high-level flexibility in project controlling. The high number of international partners, many of which contribute a large fraction of their share to the project in kind, further increases complexity. The Controlling group issues regular cost reports and forecasts that help the management board as well as all group leaders, who are responsible for their group's budget, to proactively manage the project, anticipating probable developments and risks.

Legal

The Legal group supports not only the other administrative groups but also the scientific work packages, giving legal advice on a wide range of subjects. In addition to drafting contracts with external partners, the Legal group is involved in activities such as administrative preparations for the transition to the operation phase, agreements with the user consortia, and the accession of new shareholders, for example of the two French shareholders Commissariat à l'Énergie Atomique et aux Énergies Alternatives (CEA) and Centre National de la Recherche Scientifique (CNRS) in early 2014.

Members of the Legal group serve as secretary and vice-secretary of the European XFEL Council. Their task is to support the council chair in all council matters. They stay in close contact with the international shareholders of European XFEL.

Procurement

The Procurement group ensures a legally proper and sound procurement process in accordance with German law and aims to achieve cost reductions through intensive negotiations, well-executed public tenders, and comparison of prices on quotations handed in with purchase requests.

For the Procurement group, 2014 was another challenging year. A total of 35 public tenders (8 national and 27 European Union-wide procedures) were processed; 29 were successfully awarded, leaving 6 public calls for tender that were placed before the year ended and that are expected to be awarded in January 2015. The most challenging projects in 2014 were the tenders for the second suppliers of the radio frequency power couplers for the accelerator and for the Kirkpatrick-Baez mirror system for the Small Quantum Systems (SQS) instrument.

In 2014, a total of 35 public tenders were processed; 29 were successfully awarded, leaving 6 public calls for tender that are expected to be awarded in January 2015. The most challenging projects in 2014 were the tenders for the second suppliers of the radio frequency power couplers for the accelerator and for the Kirkpatrick-Baez mirror system for the SQS instrument.

As part of procurement for civil construction, supported by seconded staff from Deutsches Elektronen-Synchrotron (DESY), 61 requests were processed. For above-ground construction on the Schenefeld campus, orders were placed for the shell construction, windows, sun protectors, and façade of the headquarters building (XHQ) as well as for infrastructure such as ground works on the campus and the roads to Osdorfer Born. For below-ground construction, orders were placed for the planning and construction of the experiment hutches and for the high-precision air conditioning system in the undulator tunnel. Many other orders were placed to support the progress of the construction work while keeping the schedule on time.

Public calls for tender covering big single purchases are only one part of the activities of the Procurement group. In total, the group processed 2424 purchase requests in 2014, an increase of 24% compared to 2013. The value of the goods and services purchased amounted to 12.6 million euro, excluding civil construction.

In 2014, the Procurement group worked intensively on the introduction and acceptance of a comprehensive new e-procurement system. This system, which went live in April, was implemented to make the complete process of purchasing—from the moment the demand is known by entering a purchase request in the system in the form of a shopping cart, through the complete approval process, all the way to placing the final order—faster, more efficient, and more effective. Since April, 1784 orders were successfully executed. The transition from a paper-based system to a fully electronic system went smoothly and without any major complications.

Knowledge management

In the second quarter of 2014, a knowledge management officer (KMO) was hired. The mission of knowledge management is to establish transparent internal policies, procedures, and processes that help preserve the collective knowledge and memory of the company. By providing an information infrastructure of well-organized and indexed data and documents, knowledge management enables individual staff members and groups to easily share their knowledge with the rest of the company.

To achieve this mission, the KMO assists work packages in meeting their documentation and knowledge exchange needs, provides the necessary guidance and framework for this exchange, coordinates the publication database for scientific and technical publications, and oversees the development of the intranet and the storage and retrieval of internal documents.

In 2014, the KMO coordinated a general strategy for documentation consolidation at European XFEL, developed additions to several existing policies, initiated and coordinated a working group for assessing and developing asset management, initiated and coordinated the establishment of an editorial board, and coordinated enhancements to the publication database to serve the documentation needs of European XFEL.

Library

Library services for European XFEL staff and guests are performed in close collaboration with the DESY Library. In the new headquarters building, a library service area is planned. The first steps to establish a small Library group were taken in 2014 with the appointment of a librarian.

The European XFEL Library is an active member of the Librarian group of EIROforum, a collaboration between eight European intergovernmental research organizations, and of which European XFEL is a member. The group met in September and prepared recommendations for the November EIROforum Directors General Assembly.

Preparing for user operation

With the start of user operation of the European XFEL facility approaching, the administrative preparations for the transition from construction to operation phase are in full swing. Given that European XFEL will become the responsible operator of the facility, administrative procedures have to be carried out that involve public authorities and considerable lead time. Internal preparations for the operation phase, such as developing staffing plans and a preliminary budget, are in progress. Setting up the User Office and designing the related workflows and infrastructure are integral parts of this activity. ■

INTERNAL AUDIT

In 2014, the internal auditor conducted audits of administrative tasks and procedures and other relevant topics at European XFEL. Additionally, the internal auditor developed a company anti-corruption policy, which has been implemented. He acts as the contact person for all questions related to the policy.

The internal auditor verifies that employees comply with corporate rules and regulations as well as laws and decrees; that the company is making appropriate and economical use of funds; and that assets are properly safeguarded. The internal auditor thus has two core tasks. The first is to focus on the legality, propriety, and regularity of the implementation of the budget and determine whether the financial management of the company is sound and effective. The second core task is to examine the processes of the company and to advise the management board on how to best optimize processes for efficiency, practicality, and suitability. ■

HUMAN RESOURCES

During 2014, staff buildup continued as scheduled, with a pace of growth that was slightly lower than during the peak years 2012 and 2013. The HR group helped recruit key people, including staff for newly formed groups.

Continuing to grow

As in previous years, 2014 was characterized by a steady increase of our workforce. The number of employees, students, and guest scientists grew from 202 to 233 (+15%). Forty-three signed contracts resulted in a net growth of 30 people as compared to the previous year. During 2014, the HR group processed 1128 applications.

Recruitment activities proved to be efficient and all job openings could be filled. Although the company hired a number of female scientists, the gender ratio among the scientists and engineers could still be further improved. The share of staff members from countries other than Germany remained at the same level as 2013.

In 2014, key positions were filled in the In-Kind Contributions, Knowledge Management, Library, Technical Services, Theory, and User Office groups. In addition, the DAQ and Control Systems group was reorganized into Advanced Electronics, Control and Analysis Software, and IT and Data Management.

EURAXESS

EURAXESS – Researchers in Motion is a pan-European initiative of the European Commission. It provides access to a range of information and support services to researchers wishing to pursue their careers in Europe.

The EURAXESS Rights programme aims at high common standards for employment and working conditions as well as fair and transparent recruitment processes for researchers throughout Europe. Enhancing the attractiveness of European research careers is one of its main objectives. European XFEL shares the goals of EURAXESS and, in December 2014, endorsed the European Charter and Code for Researchers. With this step, the company will help to make “research an attractive career, which is a vital feature of [the European Union’s] strategy to stimulate economic and employment growth”, as stated on the EURAXESS homepage. Adhering to the Charter and Code will support European XFEL’s efforts to maintain and enhance high-quality research and provide a fair and attractive research environment.

Integration of employees from other countries

A research project called “Evaluation of the effectiveness of existing internal and municipal integration measures for international employees at the European XFEL GmbH” was performed by a team of students from the University of Hamburg from May through October 2014. The results of the project, which included a survey and a set of interviews,

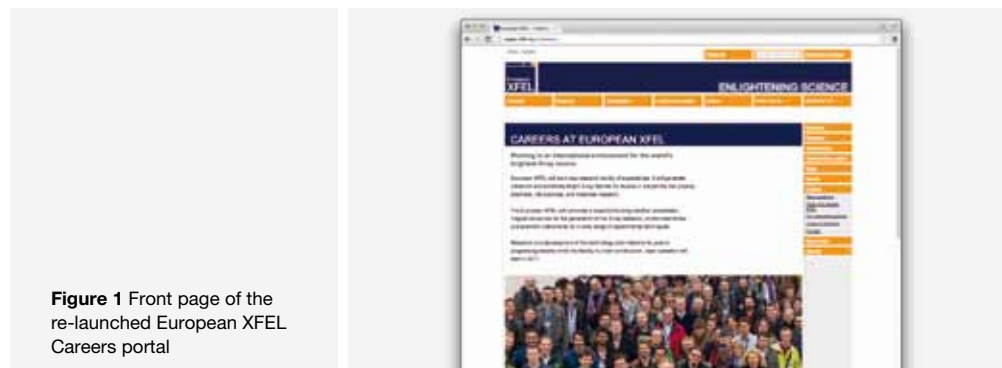

Figure 1 Front page of the re-launched European XFEL Careers portal

attest to the highly developed integration activities and welcoming culture at European XFEL. Several suggestions from the respondents will be implemented to improve the HR group's processes and tools.

The popular in-house German language classes for employees and their families continued in 2014. Employees also made active use of new in-house technical English courses.

Re-launch of the Careers portal

The re-launch of the Careers portal on the European XFEL website (Figure 1) was a major project completed in close collaboration with the Press and Public Relations (PR) group.

Besides the presentation of open positions at European XFEL, which are directly linked to the online job application tool, the Careers portal offers comprehensive information about the scientific network, salary and benefits, and company culture at European XFEL as well as tangible help in getting a work permit and moving to Hamburg.

Works Council

According to the provisions of the German Works Constitution Act (*Betriebsverfassungsgesetz*), a new Works Council was elected. It now consists of nine members to reflect the increase in the number of employees. The share of staff members from countries other than Germany on the new Works Council is 44% (which is close to the share of non-German employees at European XFEL), and the share of women is 33% (which exceeds the share of women at European XFEL).

In March, negotiation of the Works Agreement "Working time" was completed successfully. The agreement is based on trust-based working time and provides high flexibility and efficiency for company and employees alike.

In December, the revision of the Works Agreement "Objectives, feedback, and incentive pay process" was finalized. While the basic process has remained unchanged since its introduction in 2010, a few adjustments were made to improve the quality of the talks and agreements between supervisors and employees. ■

PRESS AND PUBLIC RELATIONS

The Press and Public Relations (PR) group serves as an interface between the public and European XFEL. The group ensures that comprehensive and understandable information about the objectives and the progress of the European XFEL is communicated to the media, the public, and other stakeholders in science, politics, and administration. The aim is to inform the public and the scientific community about the research opportunities at the new facility and ensure its long-term acceptance locally, nationally, and internationally. The PR group also gives advice to European XFEL staff on how to interact with the media and the public.

Objectives

The PR group works to promote European XFEL among the public and in the scientific community as follows:

- Sustaining and improving regional, national, and international press and other media coverage of the European XFEL project
- Maintaining and further improving communication through the European XFEL website (www.xfel.eu), social media, flyers, brochures, posters, and the *European XFEL Annual Report*
- Communicating information about the project to the general public, specific target groups, and different stakeholder groups (such as future users) through news articles, exhibitions, presentations, and special events
- Fostering neighbourhood relations
- Providing visitor services at the construction sites



Figure 1 The group manages media contacts with print, web, radio, television, and documentary journalists.

In addition, the PR group organizes events, represents European XFEL at selected external events, manages corporate identity, and develops communication concepts.

Accomplishments

In 2014, the PR group implemented the following communication measures, among others:

- Published news releases, press releases, and newsletters
- Organized more than 122 guided tours for 1359 visitors of the European XFEL construction sites, including representatives from the diplomatic corps of different countries, scientists, journalists, politicians, students, and other stakeholders
- Produced and published the *European XFEL Annual Report 2013*
- Supplied editorial and layout support for the new brochure *The European X-Ray Free-Electron Laser Facility and the Challenges of our Time*. In 2014, English and Polish PDF versions were distributed.
- Prepared 60 PowerPoint presentation slides on European XFEL that employees can use in their talks
- Together with the HR group, established a Careers portal on the company's website
- Contributed to the EIROforum journal for teachers, *Science in School*
- Supported scientific events, such as the 2014 European XFEL Users' Meeting, with news and photo coverage, posters, and merchandising items
- Participated in a working group—which included European XFEL Administrative Director Claudia Burger, representatives of the cities of Schenefeld and Hamburg, the district of Pinneberg, and the project company Projektgesellschaft Norderelbe—to conduct a feasibility study for a visitor or science centre at the European XFEL Schenefeld site
- Produced new merchandising items, such as writing pads and Thermos flasks with the European XFEL design
- Worked on illustrations for the future European XFEL buildings and developed a proposal for a visitor info point at the DESY Bahrenfeld site



Figure 2 The group invited neighbours living near the Osdorfer Born construction site to special tours of the shaft building and tunnel.

- Together with the PR group of Deutsches Elektronen-Synchrotron (DESY), prepared a talk on Science with XFELs at the EuroScience Open Forum (ESOF) in Copenhagen in June
- Developed and implemented a new interior design concept for the areas that are regularly frequented by visitors in the current European XFEL office building
- Offered two media training modules for the company's staff

Neighbourhood work

Throughout civil construction of the European XFEL (since 2009), the PR group is placing major emphasis on communication with local residents, as the facility is located in a predominantly residential area.

Local residents can contact the PR group's neighbourhood office at any time. Likewise, the office makes a concerted effort to reach out to all residents living near the three sites of the European XFEL and along the tunnel route. The office informs these long-term neighbours about upcoming construction work through flyers and brochures, as well as through email and postings on the European XFEL website, phone calls, and even personal visits.

In May, the office participated in the information event "The Osdorfer Feldmark—A Green Oasis in the Big City" (*"Die Osdorfer Feldmark – Grüne Oase in der Großstadt"*) with a poster exhibition presenting the compensation measures being implemented by European XFEL in the Osdorfer and Schenefelder Feldmark, a protected landscape with meadows and hedges between Hamburg and Schenefeld.

In November, the office invited the neighbours living close to the Osdorfer Born construction site to a shaft building and tunnel visit with a presentation about the progress and next steps for the facility (Figure 2). Forty people attended the tour.

The PR group regularly takes part in the weekly civil construction group meeting to inform neighbours and the public about the state of the construction project and the extent and duration of any inconveniences. In addition, the group keeps a continuously updated construction calendar on the European XFEL homepage. ■

USER OFFICE

The User Office is in charge of coordinating user services and related administrative procedures for the operation phase of the facility. The users are scientists from different research institutions invited to conduct experiments on an instrument—they are allocated “beamtime”, generally after evaluation of their projects by a committee of experts. The main responsibility of the User Office is to coordinate all logistical and practical details of user visits, so users can concentrate on science. The User Office will ensure smooth communication with users every step of the way, from planning, setting up, and conducting experiments to publishing their results. Furthermore, the User Office will support the management board in all phases of beamtime allocation.

Establishing the User Office

The head of the User Office, Silvia Bertini, was appointed in spring 2014. As a first step, Bertini gathered specific lessons learned and best practices from user offices at other large-scale research facilities. At this stage, special priority was given to planning user support services in coordination with other work packages and groups at European XFEL, including an online user portal. User portals are computing tools that combine one or more databases with specialized functionalities. A well-functioning, easy-to-access user portal is crucial for a facility of this type because it enables the standardization of administrative procedures and information processing for a large number of users, thereby increasing the overall efficiency of the system.

The User Office gratefully acknowledges the decisive support received from colleagues at other local and European facilities, in particular Deutsches Elektronen-Synchrotron (DESY) in Hamburg (especially Daniela Unger, Ulrike Lindemann, and Jan-Peter Kurz); Paul Scherrer Institut (PSI) in Villigen, Switzerland (Stefan Janssen, Markus Knecht, and colleagues); European Synchrotron Radiation Facility (ESRF) in Grenoble, France (particularly Joanne McCarthy and the ESRF User Office as well as the Travel Office team); European Molecular Biology Laboratory (EMBL) in Hamburg (Sarah Marshall, Marco Camerlenghi, Thomas Schneider, and colleagues); Helmholtz-Zentrum Berlin (HZB) in Germany (Thomas Gutberlet, Astrid Brandt, Florian Staier, and Antje Vollmer); and Karlsruhe Institute of Technology (KIT), Germany (Michael Hagelstein, Thomas Schaller, and their team).

Outlook for 2015

In 2015, the User Office will continue to develop administrative procedures, user services, and related tools in close cooperation with other work packages and groups at European XFEL. Also additional User Office staff will be recruited. ■

PHOTON SYSTEMS PROJECT OFFICE

The Photon Systems Project Office (PSPO) group ensures the computer-aided design (CAD) integration of the components of the European XFEL facility and coordinates the installation of beamline components in the photon tunnels as well as the installation of the scientific instruments and infrastructure in the experiment hall (XHEXP1). It also coordinates the company-wide risk management system.

Joint TC team and PSPO group

A joint Technical Coordination (TC) team at European XFEL and Deutsches Elektronen-Synchrotron (DESY), which recruits its members from the PSPO group at European XFEL and from DESY, acts as the prime systems integrator for the construction of the European XFEL facility. In the TC team, the PSPO group focuses on the photon beamline installations in the tunnels and the scientific instruments in XHEXP1. In addition to its role within TC, the PSPO group performs risk management for the European XFEL.

Planning and installation activities in the photon tunnels

In 2014, infrastructure installations were completed in the northern part of the photon beam distribution tunnels (XTD2, XTD4, XTD9, and XTD10; see Chapter 3, “Civil construction”, Figure 2). This infrastructure is not yet operational as it depends on other installations on the Schenefeld campus that are not yet complete. In particular, these are the auxiliary service buildings XHVAC and XHPSC, where air conditioning units, power supplies, and pumps are located. The civil construction of the latter two buildings finished in 2014, but the technical infrastructure inside will only be complete in 2015. Hence, temporary measures are required to provide clean and dry conditions in the tunnels for subsequent machine installation activities. For the moment, provisional air conditioning has been provided in XTD2. This allowed the start of photon beamline installations, including the electronics for the undulators and some of the sensitive components of the photon beam transport system. The next step is the vacuum chamber for the electron beamline and eventually the complete undulator system for SASE1. As the installation progresses to XTD4, XTD9, and XTD10, similar provisional measures will be required in order not to delay machine installation activities. All these installations are expected to be completed in 2015.

Planning of instruments and infrastructure in XHEXP1

Planning of the instrument hutches and their infrastructure in XHEXP1 continued at a high rate in 2014. The result of these efforts was the construction of the first instrument hutch, the radiation protection enclosure for the High Energy Density Science (HED) instrument in the southwest corner of the hall. Further activities were the launch of the call for tender for the SASE1 instrument hutches and the installation of the final high-quality floor in the entire hall. For each of these steps, specific challenges had to be mastered.



Figure 1 View of XTD2 with support structures for the undulators

The walls of the HED enclosure are made from heavy concrete with a density of more than 3.7 g/cm^3 . Special measures needed to be taken to avoid separation of the heavy-concrete aggregates in order to ensure adequate homogeneity of the completed walls.

The first public call for tender for the SASE1 hutches resulted in no economically viable offer and had to be issued a second time, which reduced the remaining time buffer for the final installation of the instruments in these hutches.

The last civil construction activity in 2014 in XHEXP1 was the installation of the high-quality screed with very small height tolerances and special grounding and electromagnetic shielding characteristics. The next activity will be the construction of the SASE1 hutches followed by their infrastructure in 2015.

CAD integration

One of the tasks of the PSPO group is CAD integration, which helps assure the compatibility of all interfaces and forms the basis for identifying spatial conflicts of components within the facility. CAD integration relies on all contributing partners in the project providing workable computer models of their respective components. Due to the size and complexity of the facility, strict standards for these models have to be defined and followed if the resulting integrated models are to remain manageable. The new guidelines that the PSPO group developed in 2013 for the integration models used during the engineering design phase in the photon tunnels and in the experiment hall proved practicable and successful. The complete CAD model of XHEXP1 set up previously is continuously being updated and forms the basis for all planning and installations. Significant progress was also made in implementing the PSPO guidelines for the detailed planning of the photon tunnel installations.



Figure 2 View of XHEXP1 with the final high-precision floor and the HED radiation protection enclosure

Instrument installation planning

Instrument installation planning presents special challenges. First, the scientific instruments at the European XFEL are complex and tightly integrated. Second, European XFEL has few technical resources of its own and relies on contractors for almost all hands-on installations, such as vacuum, electronics, and cabling. Finally, the instrument groups themselves require support in vacuum and electronics installations. In 2014, the PSPO group continued to provide strong support to the instrument groups. As a basis for consistent installation planning and scheduling, the PSPO group developed a standardized product breakdown structure and a template time schedule, both of which are being maintained by the PSPO group together with the instrument groups. From these two inputs, one consistent installation time schedule for all six instruments and the lasers will be drawn up. This schedule will include proper accounting for all required resources.

Risk management

In 2013, the European XFEL Management Board introduced a risk management system to identify and monitor risks that might threaten the company's existence and the timely and economical completion of the European XFEL project. To implement this system, the management board set up a risk committee and appointed a risk coordinator.

In 2014, at the request of the risk committee, the PSPO group identified and tracked about 150 risks, of which 70 are still pending; the rest have been closed. From these data, two risk reports were prepared and submitted to the European XFEL Management Board, Administrative and Finance Committee (AFC), and Council. In addition, the risk management system underwent an internal audit and was found to be comprehensive and appropriate. All of the suggestions made by the auditor for revision and improvement were subsequently implemented.

Outlook for 2015

The coming year will bring a flurry of installation activities in the photon tunnels and in XHEXP1. The SASE1 beamline in the tunnels should be completed, and work on SASE3 will start. In XHEXP1, construction of hutches and their infrastructure will take place for SASE1 and SASE3. The rapid succession of complex interdependent activities, in particular for the installation of the scientific instruments, requires setting up one comprehensive installation schedule that will be carefully monitored as work progresses, so any deviations and problems can be caught early and remedial measures can be taken. ■

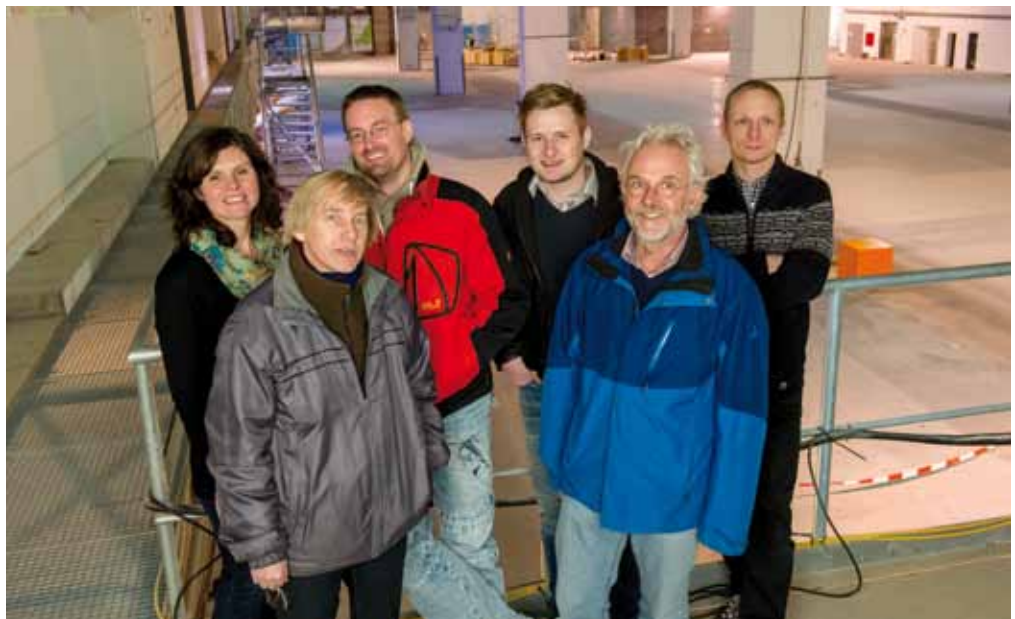

Group members
(left to right) Uschi Conta, Sabine Cunis, Gerd Wellenreuther, Niko Saaristo, Tobias Haas (group leader), and Konrad Piórecki

TECHNICAL SERVICES

The Technical Services (TS) group is responsible for the entire infrastructure supporting the scientific equipment of the European XFEL facility, as well as for all tunnels on all sites, all buildings on the Osdorfer Born and Schenefeld sites, and their respective infrastructure and services. This responsibility covers planning and construction as well as the maintenance and operation of machines and buildings.

TS group structure

The TS group consists of a hall engineer, an electrical engineer, a master technician, a mechanic, and an assistant as well as a facility management team made up of a team leader, a technical clerk, one technician, and two building services engineers. In October 2014, Lorenz Kersting joined European XFEL as the new leader of the TS group. Also coming on board were Tobias Bartsch and Michael Malso.

In 2014, two additional machines for the precision mechanical workshop were purchased.

Planning district heating for XHQ, XHEXP1, SASE1, SASE2, and SASE3

Besides their day-to-day business in the current facilities at Albert-Einstein-Ring 17 and 19, HERA South, and various buildings used by European XFEL on the Deutsches Elektronen-Synchrotron (DESY) campus, the TS facility management (FM) team focused on planning the technical infrastructure for the headquarters building (XHQ), the underground experiment hall (XHEXP1), the hard X-ray undulators (SASE1 and SASE2), and the soft X-ray undulator (SASE3).

The piping—including the installation of the distributor and pumps as well as the complete power supply and control systems—is ready for operation. District heating is now able to meet the heating requirements of the first access hall and shaft.

In addition, the planning of the company-owned district heating network for Osdorfer Born and Schenefeld was finished. This network will be located in a separate building, XHD. The local utility provider, Vattenfall, supplied and installed the heating system, which is now ready for operation. After completion of the overall construction work, Vattenfall will provide about 6 MW of heating power in total for all mentioned European XFEL properties.

The piping on the secondary side—including the installation of the distributor and pumps as well as the complete power supply and control systems of XHD—are ready for operation. The piping installation effected by DESY from XHD to the first access hall (XHE1) was finished in November 2014. With the new piping, district heating is now able to meet the heating requirements of XHE1 and Shaft 1 (XS1).

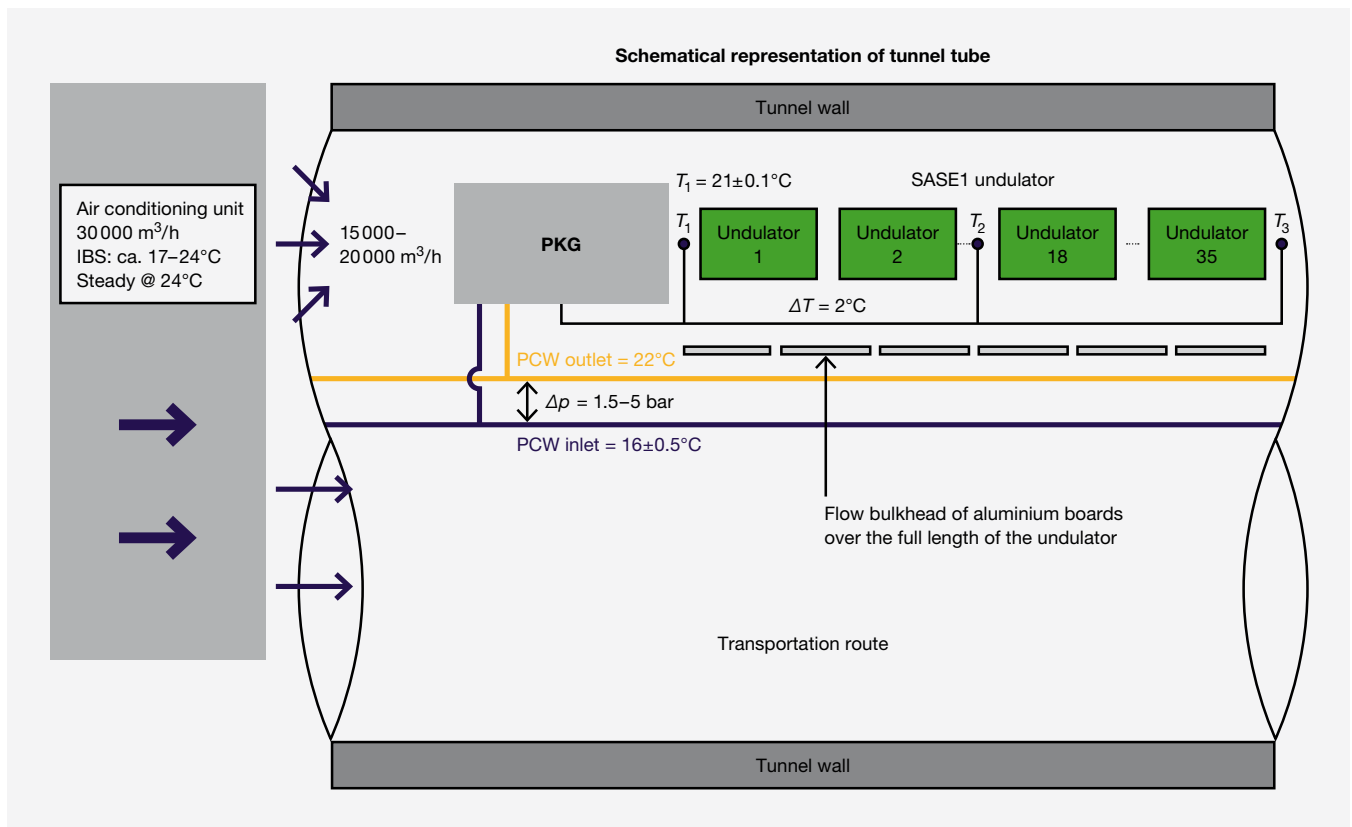

Figure 1 PKG scheme for SASE1 (PCW = process cooling water)

The piping from Osdorfer Born to Schenefeld is being laid by DESY and is estimated to be finished in March 2015. For the winter of 2014–2015, the FM team has provided temporary heating containers for buildings in Schenefeld.

Detailed engineering for XHQ

The detailed engineering for XHQ, which is nearing completion, follows these criteria:

■ Laboratory (ground floor)

- 600 m² for the Integrated Biology Infrastructure Life-Science Facility at the European XFEL (XBI) user consortium (biology/chemistry) S2 laboratory
- 1800 m² including laser laboratories, cleanroom ISO 6, IT rooms, workshops, precision measuring rooms, X-ray laboratories, and a scanning electron microscope (SEM)
- 814 m² for technical plant rooms for process measuring and control systems, precision air conditioning, chiller units, and fire alarm and detection systems

■ Offices (first and second floors)

- Offices for 167 scientific staff, 78 non-scientific staff, and 30 users
- Meeting rooms for 200 people
- Printer rooms, temporary workspaces, and so on

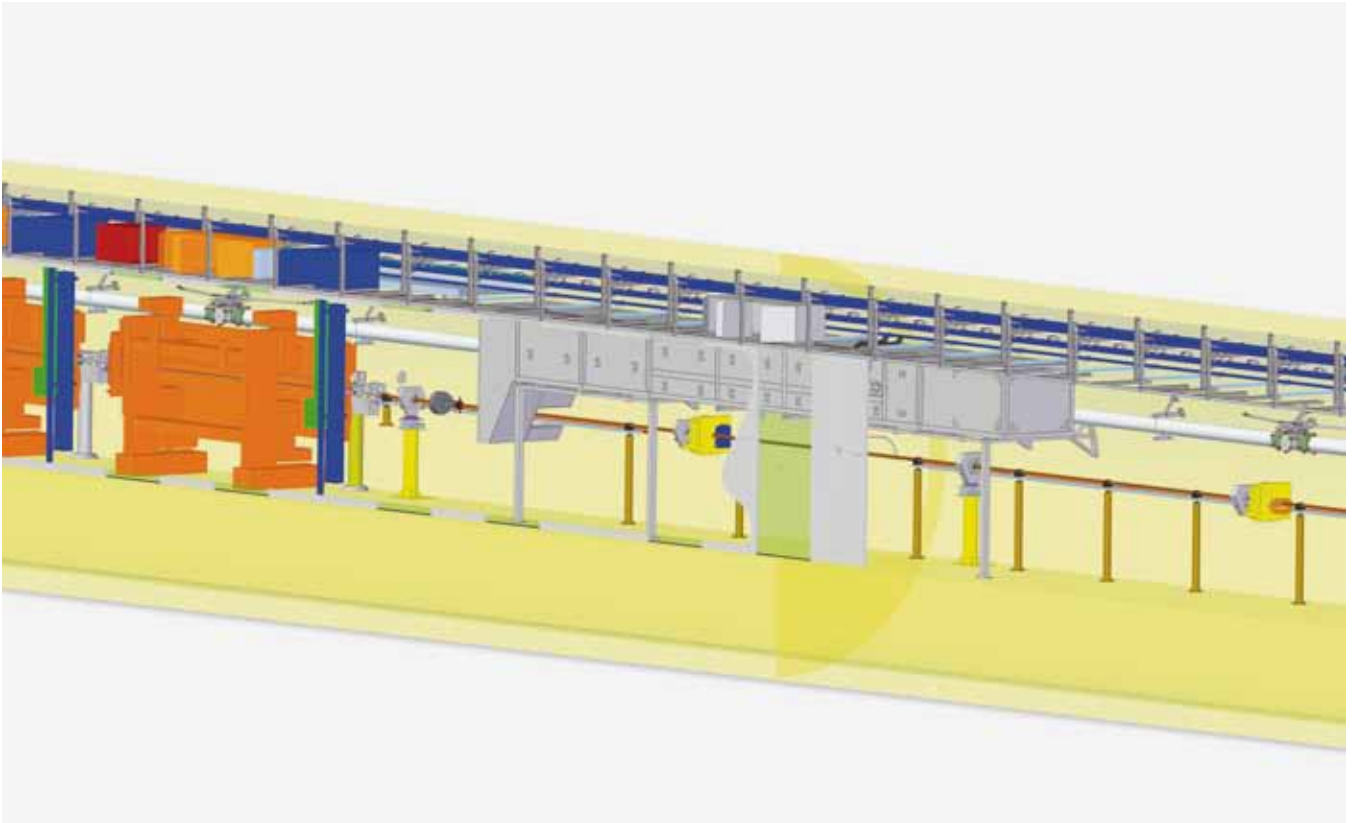

Figure 2 Isometric view of the PKG of Undulator Tunnel 2 (XTD2) for SASE1 between Room 6 and 7

The TS group planned and designed the precision climate control of the undulator tunnels. In SASE1, the rail system for the flow bulkhead of the precision air conditioning was mounted to its full length.

By the end of 2014, the following specifications for tenders were checked and awarded to external companies:

- Ventilation systems
- Heat supply
- Media supply
- Power supply
- Waste water

Tunnel climate control for SASE1, SASE2, and SASE3

Another main task for the TS group was the planning and design of the precision climate control (PKG) of the undulator tunnels. To keep the quality of the X-ray beam at a high level, a constant environmental temperature of $21 \pm 0.1^\circ\text{C}$ needs to be maintained at the outlet of the PKG unit, as shown in Figure 1. In SASE1, the rail system for the flow bulkhead of the

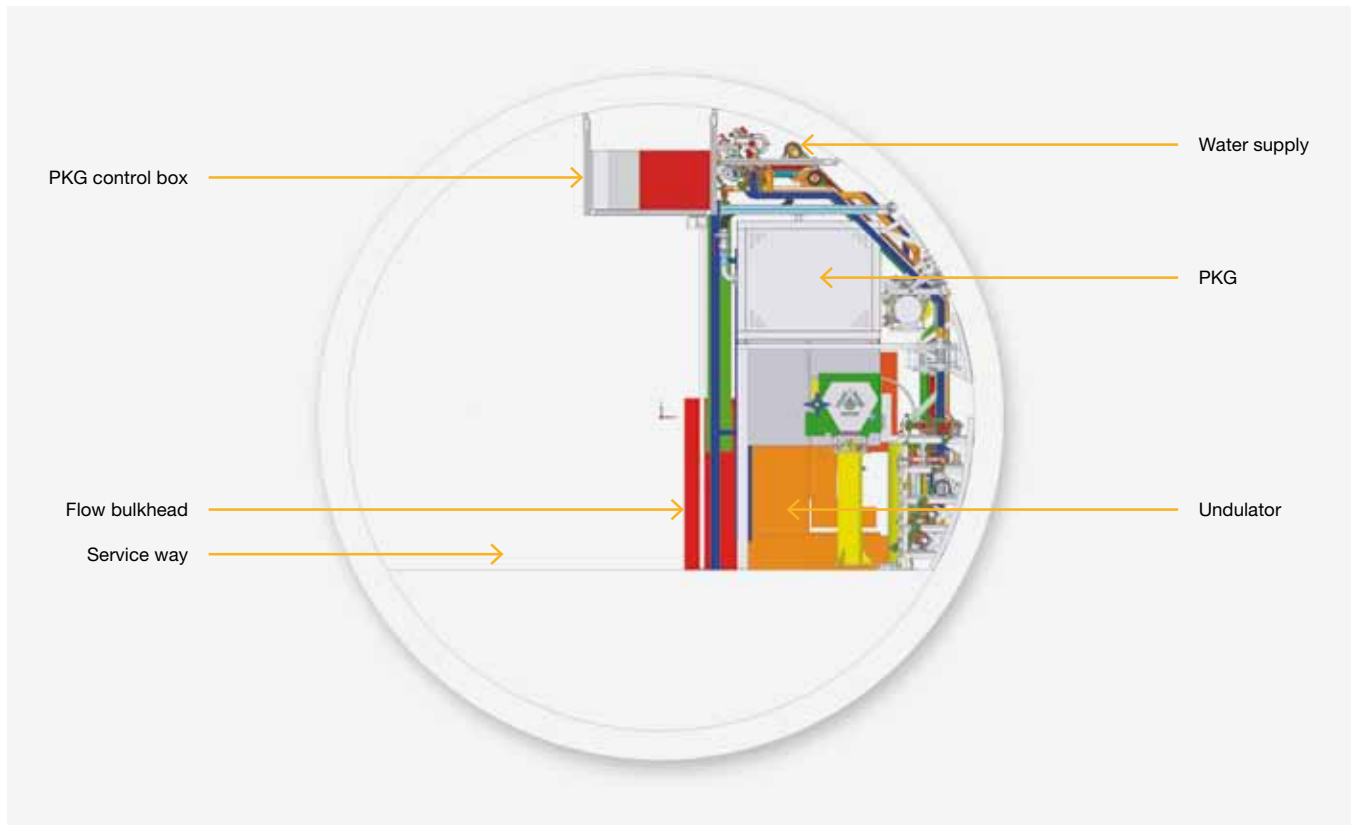

Figure 3 Section view of the 3D installation model for XTD2

precision air conditioning was mounted to its full length of 238 m. Sealing of the tunnel walls was completed as well.

Flow bulkhead of aluminium boards over the full length of the undulator

During the commissioning phase, the tunnel intake air will be roughly preheated by an electrical damper register to an adjusted set point. A reference value input serves as a controlled variable after the first air mixer. Fine adjusting will be performed by an additional heater. The reference value is measured by a temperature sensor directly at the PKG outlet as well as at the first undulator. The differences between these two values and the comparison to the nominal figures are the input for the thyristor controller of the heating system. If the temperature difference of the undulator section exceeds 2 K, the software will regulate the frequency converter of the ventilator to increase the volume flow rate of the PKG.

Outlook for 2015

At the beginning of 2015, the resumption of the deferred planning of the gate building (XHGATE) and the central workshop and stores building (XHWS) will be the major task for

the TS group. The legal procedure for financing and constructing public-sector infrastructures (*Zuwendungsverfahren Bau*) has to be initiated for XHGATE. Furthermore, the TS group will support the planning of all hutches for the SASE1, SASE2, and SASE3 instruments as well as the tender procedures for and implementation of the technical infrastructure for these instruments. In January 2015, the milling and lathe machine will temporarily be fitted on the DESY campus to support the instrument installation with the manufacturing of special prototype equipment.

Also in January 2015, the tender for the custom-made precision air conditioning devices will be awarded, including the air regulation for SASE1, SASE2, and SASE3. Moreover, the tender for the flow bulkheads of all three SASE sections will take place. The installation of the rail system for the flow bulkheads for SASE3 will begin after completion of the floor in February 2015. The same installation for SASE2 is planned for September.

Together with the Safety and Radiation Protection group, the TS group will realize the final access concepts and set up the technical emergency and security team in Schenefeld and Osdorfer Born. The contracts for the fire alarm and detection systems as well as the laboratory walls, ceilings, and floors will be awarded to external companies in January 2015. The calls for tender for laboratory equipment and furniture for the XBI user consortium laboratory will be sent out in January.

The TS group will also evaluate an adequate computer-aided facility management (CAFM) software to support the operation and maintenance of the facility in the near future. An electrical engineer will join the TS group in January 2015. Another five vacancies will have to be filled to complete the group as planned for the operation phase in 2017. ■



Group members

(left to right) Uschi Conta, Jan Oliver Kirsch, Yana Ogradowski, Torsten Schön (since January 2015), Tobias Bartsch, Marco Schrage, Carola Schulz (FM team leader), Michael Malso, Lorenz Kersting (group leader), Hrvoje Kristic, and Süleyman Arslan

SAFETY AND RADIATION PROTECTION

The Safety and Radiation Protection (SRP) group coordinates a complex network of safety engineers and representatives—as well as specialists for laser protection, hazardous materials, radiation protection, and biological safety—from individual groups throughout the company. The group reports directly to the managing directors. In the management board, the administrative director, Claudia Burger, is responsible for occupational safety and radiation protection matters at the company.

SRP group

To fulfil legal requirements, each work area has safety representatives, assigned by the managing directors, from the corresponding groups. For the two laser laboratories currently used at Deutsches Elektronen-Synchrotron (DESY), there are three laser protection officers who are members of the respective research groups working there. Safety representatives and laser protection officers work closely with the SRP group.

In 2014, three more radiation protection officers were trained and certified to support the new X-ray setup in the HERA South lab for the Detector Development group and the radiation protection work for the experiment hall (XHEXP1) in Schenefeld.

The occupational safety specialists of the SRP group provide ongoing safety support. With the start of the installation phase, especially in the underground tunnels and buildings, support activities, such as the training of additional first aiders, increased considerably during the year.

In August 2014, Michael Prollius joined the group as occupational safety specialist and radiation protection officer. His main focus is risk assessments of the current and future work areas of our employees and guests. He is responsible for granting permissions to operate cranes, forklifts, and other lifting equipment, and advises employees and external staff on personal protective equipment and hazardous substances.

Occupational safety

The SRP group offers laser and radiation protection training, and organizes first aid, fire extinguishing, and crane operation training. General safety training for new staff and guests is conducted at the beginning of each month. All training is conducted in English and German. The group also continues to prepare solutions for web-based training during the operation phase.

Together with the safety representatives, the SRP group monitors work areas to ensure safety. In 2014, more European XFEL work areas were established, from locations on the DESY campus to the underground photon tunnels between Osdorfer Born and Schenefeld. Guidance is given to group leaders responsible for work safety risk assessments of their work areas. The occupational safety specialists of the SRP group provide ongoing safety support. With the start of the installation phase, especially in the underground tunnels and buildings, support activities, such as the training of additional first aiders, increased considerably during the year.

The SRP group is also involved in the planning and coordination of the construction and installation work for the facilities on the future Schenefeld campus, particularly for the new headquarters (XHQ), XHEXP1, and the entrance building (XHGATE).

The SRP group and the laser safety officers are working closely with groups from DESY on the planning and design of the laser interlock systems to be used in XHEXP1 and the laser labs of XHQ. In addition, the SRP group and the laser safety officers are currently developing laser safety guidelines and a laser safety training programme to be implemented upon the opening of the Schenefeld campus.

Medical Service is run by the DESY company doctor, Katharina Bünz. Together with the SRP group, Medical Service ensures that the layout of work areas complies with legal requirements. A health and safety questionnaire about possible work area hazards is completed by employees. This information helps Medical Service to provide appropriate medical consultations and examinations.

The safety organization for the installation phase required a close collaboration with the DESY safety group, which is responsible for work safety at the construction site. As European XFEL employees are now planning and coordinating the experiment hutches and installing beamline components, the collaboration between both groups has been intensified to ensure that all work areas are optimally safe.

To prepare for the start of operations, regular meetings and inspection tours take place with the local fire brigades. In 2014, it was agreed that the emergency control centre located in XHGATE will be staffed by DESY Technical Emergency Service, which will also guard the facility after the company offices move to the Schenefeld campus in 2016.

The SRP and Technical Services (TS) groups have developed an access control concept—including security, safety, and emergency training—to provide employees and guests with safe access to secure sites, buildings, laboratories, and experiment stations. According to this concept, safety training requirements will be based on the outcome of work safety risk assessments of each activity or working area. Eventually, an online safety training tool will connect to the access control system as well as other databases (for example, user portal, personnel database, radiation protection database). This access control will ensure that employees and guests are adequately trained in safety and emergency procedures before they start working. The SRP and TS groups are working with the IT and Data Management group and the User Office on this complex issue.

Radiation protection

The SRP group is also responsible for the handling of radioactive sources and the operation of X-ray equipment for detector development and calibration. The first in-house X-ray setup has been approved and will now be used to test detector prototypes for the experiments. Two additional X-ray setups are being built in close cooperation with the SRP group. The radiation protection officers were involved in the planning of a personnel safety system for the experiment stations in XHEXP1. This system will be developed and implemented by the DESY Personnel Safety Systems group. The shielding and chicane design of the experiment hutches was finalized in summer 2014. This was done in close collaboration with the DESY radiation protection officers, who are responsible for the European XFEL accelerator.

Outlook for 2015

In 2015, the SRP group will finalize the safety organization concept for the operation phase of the European XFEL facility in collaboration with the Legal group, and work out the radiation protection organization concept for the commissioning and operation phase together with DESY. Internal roles and those of our partners will be clarified, and responsibilities and services will be further defined. Together with the TS group and the Central Instruments Engineering (CIE) group, the SRP group will closely examine electrical safety and machine safety.

The group plans to enhance its expertise in areas that will become more critical closer to operation, including hazardous materials handling and laser safety. The group will also recruit a laser safety expert for the operation phase.

Risk assessments of work areas and installation tasks in XHEXP1 and in the photon tunnels will continue, along with regular monitoring of those sites. In 2015, the SRP group will further intensify efforts to help group leaders assess and mitigate safety risks in their work areas.

In collaboration with the TS group and the IT and Data Management group, the SRP group will continue to implement the access management system. To support this system, an online tool for safety training is planned for the end of 2015.

The SRP group will continue to help the User Office prepare the safety aspects of the procedure that users will have to follow to submit their proposals for experiments at the European XFEL facility.

Occupational Safety Team

Safety specialists:

- Sigrid Kozielski (biological safety officer)
- Michael Prollius

Laser safety officers:

- Andreas Galler (Scientific Instrument FXE)
- Martin Kellert (Optical Lasers)
- Kai Kruse (Optical Lasers)

Radiation Protection Team

Radiation protection commissioners:

- Sigrid Kozielski
- Thomas Tschentscher

Radiation protection officers:

- Eric Boyd
- Sigrid Kozielski
- Frédéric Le Pimpec
- Michael Prollius
- Joachim Schulz ■



Group members

(left to right) Sigrid Kozielski (group leader), Michael Prollius, Sabrina Scherz, and Eric Boyd

09

SCIENTIFIC RECORD

Researchers from around the world continued to show their interest in and anticipation for the facility. Several meetings attracted hundreds of scientists. The number of publications associated with the facility also continued to increase.

Poster session at the 2014 Users' Meeting





EUROPEAN XFEL USERS' MEETING

29–31 January 2014

Deutsches Elektronen-Synchrotron (DESY), Hamburg, Germany

The joint European XFEL and DESY Photon Science Users' Meeting is an annual opportunity to strengthen the interaction between European XFEL and the scientific user community. At the eighth meeting, the number of participants broke the record from the previous year yet again: over 600 people attended the first day's sessions, which were specifically organized for European XFEL. The programme included talks, several workshops, a satellite meeting for the High Energy Density Science (HED) instrument, and a poster session with more than 300 posters. Participants discussed details of the European XFEL project, future experiments, user consortia, and recent updates within the field of photon science. More than 30 students from around the world attended on travel grants disbursed by European XFEL.

The Users' Meeting focused on the following topics:

- Progress and current status of the European XFEL
- Instrument design developments and advances
- Selected science applications
- Current developments and recent results in the field of X-ray free-electron laser facilities
- Job opportunities at European XFEL



Figure 1 Participants of the 2014 European XFEL Users' Meeting

HARD X-RAY FEL COLLABORATION MEETING

19–21 May 2014

Hosted by European XFEL on the DESY Campus

The Hard X-Ray FEL Collaboration Meeting is an annual platform for exchange and interaction between the hard X-ray free-electron laser (FEL) facilities that are currently operating or under construction around the world. The sixth meeting, attended by approximately 90 participants, was between five such facilities: the Linac Coherent Light Source (LCLS) at SLAC National Accelerator Laboratory in Menlo Park, California; the SPring-8 Angstrom Compact Free Electron Laser (SACLA) at RIKEN in Hyogo, Japan; the Pohang Accelerator Laboratory XFEL (PAL-XFEL) in Pohang, South Korea; the European XFEL in Hamburg, Germany; and SwissFEL at Paul Scherrer Institut (PSI) in Villigen, Switzerland. Attendees discussed construction and upgrade progress, recent results, and future plans as more hard X-ray FEL instruments come online over the next several years. In addition to the plenary talks, there were breakout sessions for accelerator and X-ray systems. The next meeting will be in October 2015 at PSI.

SECOND RACIRI SUMMER SCHOOL ON ADVANCED MATERIALS DESIGN AT X-RAY AND NEUTRON SOURCES

24–31 August 2014

Stockholm Area, Sweden

Jointly organized by leading research organizations from Russia, Sweden, and Germany, the second RACIRI Summer School featured lectures from representatives from operating and upcoming X-ray and neutron sources in each of these countries, as well as scientists from other universities and laboratories around the world. The summer school originated from a cooperation between the Röntgen-Ångström-Cluster (RAC), a partnership between Germany and Sweden, and the Ioffe-Röntgen-Institute (IRI), a partnership between Germany and Russia. The second iteration of the summer school had a special focus on imaging techniques at X-ray and neutron facilities, in particular new advances in structural biology and molecular and single particle imaging, and featured talks by speakers from Uppsala University in Sweden, European XFEL and Center for Free-Electron Laser Science (CFEL) in Germany, and National Research Centre “Kurchatov Institute” in Russia, among others.

WORKSHOPS

8–9 April 2014

3rd Collaboration Meeting of the European XFEL

Organized by European XFEL and Deutsches Elektronen-Synchrotron (DESY) on the DESY campus, Hamburg, Germany

This meeting gathered the international collaboration that is constructing the European XFEL. The meeting covered the accelerator construction and its related infrastructure, the photon beamlines, and the instruments.

21–23 May 2014

Workshop on Advanced X-Ray FEL Development

Organized by European XFEL and DESY on the DESY campus, Hamburg, Germany

The workshop focused on the experimental requirements for X-ray FEL pulses and challenges from the user community, the present status of self-seeding methods, the generation of multicolour spectra, alternative techniques for controlling the longitudinal phase space of FEL radiation, tapering techniques and limitations on energy exchange between electron and X-ray pulses, progress and perspective on the design of compact FELs based on laser or plasma accelerators, and diagnostics and manipulation of the longitudinal phase space of the electron beam. ■

SEMINARS

24 February 2014

Development of Split-Delay Optical System at SACLA

Taito Osaka, Department of Precision Science and Technology, Graduate School of Engineering, Osaka University, Japan

24 February 2014

Fabrication and characterization of platinum/carbon multilayers

Kim Jangwoo, Department of Precision Science and Technology, Graduate School of Engineering, Osaka University, Japan

3 March 2014

Application of Single Crystal Diamonds for X-Ray Optics

S. Terentiev, Technological Institute for Superhard and Novel Carbon Materials (FSBI TISNCM), Troitsk, Moscow, Russia

6 June 2014

Radiation damage in serial femtosecond macromolecular crystallography at the X-ray laser

Karol Nass, Max Planck Institute (MPI) for Medical Research, Heidelberg, Germany

3 July 2014

Using LCLS-based hard X-ray scattering and THz excitation to study switching dynamics of phase-change memory materials

Peter Zalden, SLAC National Accelerator Laboratory, Menlo Park, California

31 July 2014

Light sources in China

Hesheng Chen, Institute of High Energy Physics (IHEP), Beijing, China

25 August 2014

LCLS approach to the planning of instrumentation projects

Paul Montanez, Linac Coherent Light Source (LCLS), SLAC National Accelerator Laboratory, Menlo Park, California

13 October 2014

OMNY: an instrument for tomographic X-ray nano imaging

Mirko Holler, Swiss Light Source (SLS), Paul Scherrer Institut (PSI), Villigen, Switzerland

29 October 2014

Stimulated X-ray Raman scattering with free-electron laser sources

Nina Rohringer, Center for Free-Electron Laser Science (CFEL), Deutsches Elektronen-Synchrotron (DESY), Hamburg, Germany ■

PUBLICATIONS

JOURNALS

A 31T Split-Pair Pulsed Magnet for Single Crystal X-Ray Diffraction at low Temperature

F. Duc, X. Fabrèges, T. Roth, C. Detlefs, P. Frings, M. Nardone, J. Billette, M. Lesourd, L. Zhang, A. Zitouni, P. Delescluse, J. Béard, J.P. Nicolin, G.L.J.A. Rikken
 Rev. Sci. Instrum. **85** (2014) 5, 053905
 doi:10.1063/1.4878915

Absolute flatness measurement using oblique incidence setup and an iterative algorithm period. A demonstration on synthetic data

M. Vannoni
 Optics Express **22** (2014) 3, 3538
 doi:10.1364/OE.22.003538

Absolute Pulse Energy Measurements of Soft X-Rays at the Linac Coherent Light Source

K. Tiedtke, A.A. Sorokin, U. Jastrow, P. Juranić, S. Kreis, N. Gerken, M. Richter, U. Arp, Y. Feng, D. Nordlund, R. Soufli, M. Fernández-Perea, L. Juha, P. Heimann, B. Nagler, H.J. Lee, S. Mack, M. Cammarata, O. Krupin, M. Messerschmidt, M. Holmes, M. Rowen, W. Schlotter, S. Moeller, J.J. Turner
 Optics Express **22** (2014) 18, 21214
 doi:10.1364/OE.22.021214

Aging behavior of the localization length in a colloidal glass

R. Angelini, A. Madsen, A. Fluerasu, G. Ruocco, B. Ruzicka
 Colloids and Surfaces A: Physicochemical and Engineering Aspects **460** (2014), 118–122
 doi:10.1016/j.colsurfa.2014.03.087

Angle-resolved study of resonant Auger decay and fluorescence emission processes after core excitations of the terminal and central nitrogen atoms in N₂O

A. Knie, M. Ilchen, P. Schmidt, P. Reiß, C. Ozga, B. Kambs, A. Hans, N. Möglich, S.A. Galitskiy, L. Glaser, P. Walter, J. Viehhaus, A. Ehresmann, P.V. Demekhin
 Phys. Rev. A **90** (2014), 013416
 doi:10.1103/PhysRevA.90.013416

Anomalous Dynamics at the Hard-Sphere Glass Transition

P. Kwaśniewski, A. Fluerasu, A. Madsen
 Soft Matter **10** (2014) 43, 8698–8704
 doi:10.1039/C4SM01671H

Control of the Polarization of a Vacuum-Ultraviolet, High-Gain, Free-Electron Laser

E. Allaria, B. Diviacco, C. Callegari, P. Finetti, B. Mahieu, J. Viefhaus, M. Zangrando, G. De Ninno, G. Lambert, E. Ferrari, J. Buck, M. Ilchen, B. Vodungbo, N. Mahne, C. Svetina, C. Spezzani, S. Di Mitri, G. Penco, M. Trovó, W.M. Fawley, P.R. Rebernik, D. Gauthier, C. Grazioli, M. Coreno, B. Ressel, A. Kivimäki, T. Mazza, L. Glaser, F. Scholz, J. Seltmann, P. Gessler, J. Gruenert, A. De Fanis, M. Meyer, A. Knie, S.P. Moeller, L. Raimondi, F. Capotondi, E. Pedersoli, O. Plekan, M.B. Danailov, A. Demidovich, I. Nikolov, A. Abrami, J. Gautier, J. Lüning, P. Zeitoun, L. Giannessi
 Phys. Rev. X **4** (2014), 041040
 doi:10.1103/PhysRevX.4.041040

Detectors and Calibration Concept for the European XFEL

M. Kuster, D. Boukhelef, M. Donato, J.-S. Dambietz, S. Hauf, L. Maia, N. Raab, J. Szuba, M. Turcato, K. Wrona, C. Youngman
 Synchrotron Radiation News **27** (2014) 4, 35–38
 doi:10.1080/08940886.2014.930809

Development of experimental techniques for the characterization of ultrashort photon pulses of extreme ultraviolet free-electron lasers

S. Düsterer, M. Rehders, A. Al-Shemmary, C. Behrens, G. Brenner, O. Brovko, M. Dell'Angela, M. Drescher, B. Faatz, J. Feldhaus, U. Frühling, N. Gerasimova, N. Gerken, C. Gerth, T. Golz, A. Grebentsov, E. Hass, K. Honkavaara, V. Kocharian, M. Kurka, Th. Limberg, R. Mitzner, R. Moshhammer, E. Plönjes, M. Richter, J. Rönsch-Schulenburg, A. Rudenko, H. Schlarb, B. Schmidt, A. Senfleben, E.A. Schneidmiller, B. Siemer, F. Sorgenfrei, A.A. Sorokin, N. Stojanovic, K. Tiedtke, R. Treusch, M. Vogt, M. Wieland, W. Wurth, S. Wesch, M. Yan, M.V. Yurkov, H. Zacharias, S. Schreiber
 Phys. Rev. ST Accel. Beams **17** (2014), 120702
 doi:10.1103/PhysRevSTAB.17.120702

Diffusion effects in undulator radiation

I. Agapov, G.A. Geloni
 Phys. Rev. ST Accel. Beams **17** (2014), 110704
 doi:10.1103/PhysRevSTAB.17.110704

Double Hexagonal Close-Packed Structure Revealed in a Single Colloidal Crystal Grain by Bragg Rod Analysis

J.-M. Meijer, A. Shabalin, R. Dronyak, O.M. Yefanov, A. Singer, R.P. Kurta, U. Lorenz, O. Gorobstov, D. Dzhigaev, J. Gulden, D.V. Byelov, A.V. Zozulya, M. Sprung, I.A. Vartanyants, A.V. Petukhov
 J. Appl. Cryst. **47** (2014) 4, 1199–1204
 doi:10.1107/S1600576714010346

Elemental anomalies in the hippocampal formation after repetitive electrical stimulation: an X-ray fluorescence microscopy study

J. Chwiej, H. Gabrys, K. Janeczko, J. Kutorasinska, K. Gzielo-Jurek, K. Matusiak, K. Appel, Z. Setkowicz
 JBIC Journal of Biological Inorganic Chemistry **19** (2014) 7, 1209–1220
 doi:10.1007/s00775-014-1177-7

Equilibration dynamics and conductivity of warm dense hydrogen

U. Zastra, P. Sperling, A. Becker, T. Bornath, R. Bredow, T. Döppner, S. Dziarzhytski, T. Fennel, L.B. Fletcher, E. Förster, C. Fortmann, S.H. Glenzer, S. Göde, G. Gregori, M. Harmand, V. Hilbert, B. Holst, T. Laarmann, H.J. Lee, T. Ma, J.P. Mithen, R. Mitzner, C.D. Murphy, M. Nakatsutsumi, P. Neumayer, A. Przystawik, S. Roling, M. Schulz, B. Siemer, S. Skruszewicz, J. Tiggesbäumker, S. Toleikis, T. Tschentscher, T. White, M. Wöstmann, H. Zacharias, R. Redmer

Phys. Rev. E **90** (2014), 013104

doi:10.1103/PhysRevE.90.013104

Evidence for a glassy state in strongly driven carbon

C.R.D. Brown, D.O. Gericke, M. Cammarata, B.I. Cho, T. Döppner, K. Engelhorn, E. Förster, C. Fortmann, D. Fritz, E. Galtier, S.H. Glenzer, M. Harmand, P. Heimann, N.L. Kugland, D.Q. Lamb, H.J. Lee, R.W. Lee, H. Lemke, M. Makita, A. Moinard, C.D. Murphy, B. Nagler, P. Neumayer, K.-U. Plagemann, R. Redmer, D. Riley, F.B. Rosmej, P. Sperling, S. Toleikis, S.M. Vinko, J. Vorberger, S. White, T.G. White, K. Wünsch, U. Zastra, D. Zhu, T. Tschentscher, G. Gregori

Scientific Reports **4** (2014), 5214

doi:10.1038/srep05214

First RACIRI Summer School on Advanced Materials Design at X-ray and Neutron Sources

F. Lehner, S. Molodtsov

Synchrotron Radiation News **27** (2014) 2, 44–45

doi:10.1080/08940886.2014.889553

High-dynamic-range coherent diffractive imaging: ptychography using the mixed-mode pixel array detector

K. Giewekemeyer, H.T. Philipp, R.N. Wilke, A. Aquila, M. Osterhoff, M.W. Tate, K.S. Shanks, A.V. Zozulya, T. Salditt, S.M. Gruner, A.P. Mancuso

J. Synchrotron Rad. **21** (2014) 5, 1167–1174

doi:10.1107/S1600577514013411

High power burst-mode optical parametric amplifier with arbitrary pulse selection

M. Pergament, M. Kellert, K. Kruse, J. Wang, G. Palmer, L. Wissmann, U. Wegner, M.J. Lederer

Optics Express **22** (2014) 18, 22202–22210

doi:10.1364/OE.22.022202

High-precision x-ray FEL pulse arrival time measurements at SACLA by a THz streak camera with Xe clusters

P.N. Juranić, A. Stepanov, R. Ischebeck, V. Schlott, C. Pradervand, L. Patthey, M. Radović, I. Gorgisyan, L. Rivkin, C.P. Hauri, B. Monoszlai, R. Ivanov, P. Peier, J. Liu, T. Togashi, S. Owada, K. Ogawa, T. Katayama, M. Yabashi, R. Abela

Optics Express **22** (2014) 24, 30004

doi:10.1364/OE.22.030004

Hydration shell effects in the relaxation dynamics of photoexcited Fe-II complexes in water

P. Nalbach, A.J.A. Achner, M. Frey, M. Grosser, C. Bressler, M. Thorwart
J. Chem. Phys. **141** (2014) 4, 044304
doi:10.1063/1.4890528

Imaging Molecular Structure through Femtosecond Photoelectron Diffraction on Aligned and Oriented Gas-Phase Molecules

R. Boll, A. Rouzée, M. Adolph, D. Anielski, A. Aquila, S. Bari, C. Bomme, Ch. Bostedt, J.D. Bozek, H.N. Chapman, L. Christensen, R. Coffee, N. Coppola, S. De, P. Decleva, S.W. Epp, B. Erk, F. Filsinger, L. Foucar, T. Gorkhover, L. Gumprecht, A. Hömke, L. Holmegaard, P. Johnsson, J.S. Kienitz, Th. Kierspel, F. Krasniqi, K.-U. Kühnel, J. Maurer, M. Messerschmidt, R. Moshhammer, N.L.M. Müller, B. Rudek, E. Savelyev, I. Schlichting, C. Schmidt, F. Scholz, S. Schorb, J. Schulz, J. Seltmann, M. Stener, S. Stern, S. Techert, J. Thøgersen, S. Trippel, J. Viefhaus, M. Vrakking, H. Stapelfeldt, J. Küpper, J. Ullrich, A. Rudenko, D. Rolles
Faraday Discuss. **171** (2014), 57–80
doi:10.1039/C4FD00037D

Interference effects in super-radiant THz sources

V. Asgekar, G. Geloni, V. Kocharyan, N. Stojanovic, P. Michel, M. Gensch
Infrared Physics & Technology **64** (2014), 26–32
doi:10.1016/j.infrared.2014.01.009

Laser-induced charge-disproportionated metallic state in LaCoO₃

M. Izquierdo, M. Karolak, C. Trabant, K. Holldack, A. Föhlisch, K. Kummer, D. Prabhakaran, A.T. Boothroyd, M. Spiwek, A. Belozerov, A. Poteryaev, A. Lichtenstein, S.L. Molodtsov
Phys. Rev. B **90** (2014) 23, 235128
doi:10.1103/PhysRevB.90.235128

Measuring the temporal structure of few-femtosecond free-electron laser X-ray pulses directly in the time domain

W. Helml, A.R. Maier, W. Schweinberger, I. Grguraš, P. Radcliffe, G. Doumy, C. Roedig, J. Gagnon, M. Messerschmidt, S. Schorb, C. Bostedt, F. Grüner, L.F. DiMauro, D. Cubaynes, J.D. Bozek, Th. Tschentscher, J.T. Costello, M. Meyer, R. Coffee, S. Düsterer, A.L. Cavalieri, R. Kienberger
Nature Photonics **8** (2014) 12, 950–957
doi:10.1038/nphoton.2014.278

Monitoring the thinning dynamics of soap films by phase shift interferometry. The case of perfluoropolyether surfactants

C.M.C. Gambi, M. Vannoni, A. Sordini, G. Molesini
The European Physical Journal E **37** (2014) 2, 9
doi:10.1140/epje/i2014-14009-2

OCELOT: A software framework for synchrotron light source and FEL studies

I. Agapov, G.A. Geloni, S. Tomin, I. Zagorodnov
Nuclear Instruments and Methods in Physics Research Section A **768** (2014), 151–156
doi:10.1016/j.nima.2014.09.057

Radiation detectors based on microchannel plates for free-electron lasers

E. Syresin, O. Brovko, A. Grebentsov, N. Zamjatin, A. Shabunov, M. Yurkov, J. Gruenert, W. Freund, D. Novikov, R. Basta, T. Fiala, P. Hedbavny
Physics of Particles and Nuclei Letters **11** (2014) 6, 730–736
doi:10.1134/S1547477114060144

Real-Time Visualization of Nanocrystal Solid-Solid Transformation Pathways

J.S. Wittenberg, T.A. Miller, E. Szilagy, K. Lutker, F. Quirin, W. Lu, H. Lemke, D. Zhu, M. Chollet, J. Robinson, H. Wen, K. Sokolowski-Tinten, A.P. Alivisatos, A.M. Lindenberg
Nano Lett. **14** (2014) 4, 1995–1999
doi:10.1021/nl500043c

Resolving Ultrafast Heating of Dense Cryogenic Hydrogen

U. Zastrau, P. Sperling, M. Harmand, A. Becker, T. Bornath, R. Bredow, S. Dziarzhytski, T. Fennel, L.B. Fletcher, E. Förster, S. Göde, G. Gregori, V. Hilbert, D. Hochhaus, B. Holst, T. Laarmann, H.J. Lee, T. Ma, J.P. Mithen, R. Mitzner, C.D. Murphy, M. Nakatsutsumi, P. Neumayer, A. Przystawik, S. Roling, M. Schulz, B. Siemer, S. Skruszewicz, J. Tiggesbäumker, S. Toilekis, T. Tschentscher, T. White, M. Wöstmann, H. Zacharias, T. Döppner, S.H. Glenzer, R. Redmer
Phys. Rev. Lett. **112** (2014), 105002
doi:10.1103/PhysRevLett.112.105002

Solvation dynamics monitored by combined X-ray spectroscopies and scattering: photoinduced spin transition in aqueous [Fe(bpy)₃]²⁺

C. Bressler, W. Gawelda, A. Galler, M.M. Nielsen, V. Sundström, G. Doumy, A.M. March, S.H. Southworth, L. Young, G. Vankó
Faraday Discuss. **171** (2014), 169–178
doi:10.1039/C4FD00097H

Spatio-temporal coherence of free-electron laser radiation in the extreme ultraviolet determined by a Michelson interferometer

V. Hilbert, C. Rödel, G. Brenner, T. Döppner, S. Düsterer, S. Dziarzhytski, L. Fletcher, E. Förster, S.H. Glenzer, M. Harmand, N.J. Hartley, L. Kazak, D. Komar, T. Laarmann, H.J. Lee, T. Ma, M. Nakatsutsumi, A. Przystawik, H. Redlin, S. Skruszewicz, P. Sperling, J. Tiggesbäumker, S. Toilekis, U. Zastrau
Appl. Phys. Lett. **105** (2014) 10, 101102
doi:10.1063/1.4895455

Structural biology at the European X-ray free-electron laser facility

M. Altarelli, A.P. Mancuso
Philosophical Transactions B **369** (2014) 1647, 20130311
doi:10.1098/rstb.2013.0311

Studying planetary matter using intense x-ray pulses

K. Appel, M. Nakatsutsumi, M. Pelka, G. Priebe, I. Thorpe, Th. Tschentscher
Plasma Phys. Control. Fusion **57** (2015), 014003
doi:10.1088/0741-3335/57/1/014003

Sub-femtosecond precision measurement of relative X-ray arrival time for free-electron lasers

N. Hartmann, W. Helml, A. Galler, M.R. Bionta, J. Gruenert, S.L. Molodtsov, K.R. Ferguson, S. Schorb, M.L. Swiggers, S. Carron, C. Bostedt, J.-C. Castagna, J. Bozek, J.M. Glowina, D.J. Kane, A.R. Fry, W.E. White, C.P. Hauri, T. Feuerer, R.N. Coffee
 Nature Photonics **8** (2014), 706–709
 doi:10.1038/nphoton.2014.164

Synthesis of nanostructured chitina–hematite composites under extreme biomimetic conditions

M. Wysokowski, M. Motylenko, J. Walter, G. Lota, J. Wojciechowski, H. Stöcker, R. Galli, A.L. Stelling, C. Himcinski, E. Niederschlag, E. Langer, V.V. Bazhenov, T. Szatkowski, J. Zdarta, I. Pertenko, Z. Kljajić, T. Leisegang, S.L. Molodtsov, D.C. Meyer, T. Jesionowski, H. Ehrlich
 RSC Advances **4** (2014) 106, 61743–61752
 doi:10.1039/C4RA10017D

The role of space charge in spin-resolved photoemission experiments

A. Fognini, G. Salvatella, T.U. Michlmayr, C. Wetli, U. Ramsperger, T. Baehler, F. Sorgenfrei, M. Beye, A. Eschenlohr, N. Pontius, C. Stamm, F. Hieke, M. Dell’Angela, S. de Jong, R. Kukreja, N. Gerasimova, V. Rybnikov, H. Redlin, J. Raabe, A. Foehlich, H. Duerr, W. Wurth, D. Pescia, A. Vaterlaus, Y. Acremann
 New Journal of Physics **16** (2014), 043031
 doi:10.1088/1367-2630/16/4/043031

Time-Dependent Wave Front Propagation Simulation of a Hard X-Ray Split-and-Delay unit: Towards a Measurement of the Temporal Coherence Properties of X-Ray Free Electron Lasers

S. Roling, H. Zacharias, L. Samoylova, H. Sinn, Th. Tschentscher, O. Chubar, A. Buzmakov, E. Schneidmiller, M.V. Yurkov, F. Siewert, S. Braun, P. Gawlitza
 Phys. Rev. ST Accel. Beams **17** (2014), 110705
 doi:10.1103/PhysRevSTAB.17.110705

Towards simultaneous measurements of electronic and structural properties in ultra-fast x-ray free electron laser absorption spectroscopy experiments

J. Gaudin, C. Fourment, B.I. Cho, K. Engelhorn, E. Galtier, M. Harmand, P.M. Leguay, H.J. Lee, B. Nagler, M. Nakatsutsumi, C. Ozkan, M. Störmer, S. Toleikis, T. Tschentscher, P.A. Heimann, F. Dorchies
 Scientific Reports **4** (2014), 4724
 doi:10.1038/srep04724

Tracing ultrafast dynamics of strong fields at plasma-vacuum interfaces with longitudinal proton probing

F. Abicht, J. Braenzel, G. Priebe, C. Koschitzki, A.A. Andreev, P.V. Nickles, W. Sandner, M. Schnürer
 Appl. Phys. Lett. **105** (2014), 034101
 doi:10.1063/1.4891167

Tracking excited-state charge and spin dynamics in iron coordination complexes

W. Zhang, R. Alonso-Mori, U. Bergmann, C. Bressler, M. Chollet, A. Galler, W. Gawelda, R.G. Hadt, R.W. Hartsock, T. Kroll, K.S. Kjær, K. Kubicek, H.T. Lemke, H.W. Liang, D.A. Meyer, M.M. Nielsen, C. Purser, J.S. Robinson, E.I. Solomon, Z. Sun, D. Sokaras, T.B. van Driel, G. Vankó, T.-C. Weng, D. Zhu, K.J. Gaffney
 Nature **509** (2014), 345–348
 doi:10.1038/nature13252

Two MHz tunable non collinear optical parametric amplifiers with pulse durations down to 6 fs

J. Nillon, O. Crégut, C. Bressler, S. Haacke
 Optics Express **22** (2014) 12, 14964–14974
 doi:10.1364/OE.22.014964

Visualizing a protein quake with time-resolved X-ray scattering at a free-electron laser

D. Arnlund, L.C. Johansson, C. Wickstrand, A. Barty, G.J. Williams, E. Malmerberg, J. Davidsson, D. Milathianaki, D.P. DePonte, R.L. Shoeman, D. Wang, D. James, G. Katona, S. Westenhoff, Th.A. White, A. Aquila, S. Bari, P. Berntsen, M. Bogan, T. Brandt van Driel, R.B. Doak, K.S. Kjær, M. Frank, R. Fromme, I. Grotjohann, R. Henning, M.S. Hunter, R.A. Kirian, I. Kosheleva, Ch. Kupitz, M. Liang, A.V. Martin, M.M. Nielsen, M. Messerschmidt, M.M. Seibert, J. Sjöhamn, F. Stellato, U. Weierstall, N.A. Zatsepin, J.C.H. Spence, P. Fromme, I. Schlichting, S. Boutet, G. Groenhof, H.N. Chapman, R. Neutze
 Nature Methods **11** (2014) 9, 923–926
 doi:10.1038/nmeth.3067

REPORTS**Brightness of Synchrotron radiation from Undulators and Bending Magnets**

G.A. Geloni, V. Kocharyan, E. Saldin
 Red Report (2014)
 DESY 14-129
 arXiv:1407.4591

Brightness of synchrotron radiation from wigglers

G. Geloni, V. Kocharyan, E. Saldin
 Red Report (2014)
 DESY 14-235
 arXiv:1412.2648

Diffraction Orders of the SASE3 Monochromator

N. Gerasimova
 Technical Report (2014)
 XFEL.EU TR-2014-003
 doi:10.3204/XFEL.EU/TR-2014-003

European XFEL Annual Report 2013

M. Altarelli et al.
Annual Report (2014)
XFEL.EU AR-2013
doi:10.3204/XFEL.EU/AR-2013

Perspectives of Imaging of Single Protein Molecules with the Present Design of the European XFEL. - Part I - X-ray Source, Beamline Optics and Instrument Simulations

S. Serkez, V. Kocharyan, E. Saldin, I. Zagorodnov, G.A. Geloni, O. Yefanov
Red Report (2014)
DESY 14-137
ISSN 0418-9833
arXiv:1407.8450

Strahlenschutzmaßnahmen für den Betrieb des UHI-Laser am HED Instrument

T. Tschentscher
Technical Note (2014)
XFEL.EU TN-2014-002-01

Technical Design Report: Scientific Instrument High Energy Density Physics (HED)

M. Nakatsutsumi, K. Appel, G. Priebe, I. Thorpe, A. Pelka, B. Muller, Th. Tschentscher
Technical Report (2014)
XFEL.EU TR-2014-001
doi:10.3204/XFEL.EU/TR-2014-001

The Full Potential of the Baseline SASE Undulators of the European XFEL

I. Agapov, G.A. Geloni, G. Feng, V. Kocharyan, E. Saldin, S. Serkez, I. Zagorodnov
Red Report (2014)
DESY 14-047
arXiv:1404.1177

The Undulator Commissioning Spectrometer for the European XFEL

W. Freund
Technical Note (2014)
XFEL.EU TN-2014-001-01

CONTRIBUTIONS TO CONFERENCE PROCEEDINGS**A hard x-ray split-and-delay unit for the HED experiment at the European XFEL**

S. Roling, K. Appel, S. Braun, A. Buzmakov, O. Chubar, P. Gawlitza, L. Samoylova, B. Siemer, E. Schneidmiller, H. Sinn, F. Siewert, Th. Tschentscher, F. Wahlert, M. Wöstmann, M. Yurkov, H. Zacharias
 SPIE Optical Engineering + Applications, San Diego, California, 9–13 August 2014
 Proc. SPIE 9210, X-Ray Free-Electron Lasers: Beam Diagnostics, Beamline Instrumentation, and Applications II, 92100B (2014)
 doi:10.1117/12.2061879

An Error Function Minimization Approach for the inverse Problem of Adaptive Mirrors Tuning

M. Vannoni, F. Yang, F. Siewert, H. Sinn
 SPIE Optical Engineering + Applications, San Diego, California, 17 August 2014
 Proc. SPIE 9208, Adaptive X-Ray Optics III, 92080I (2014)
 doi:10.1117/12.2061177

Beam transport and focusing layout based on adaptive optics for the SQS scientific instrument at the European XFEL

T. Mazza, R. Signorato, M. Meyer, D. La Civita, M. Vannoni, H. Sinn
 SPIE Optical Engineering + Applications, San Diego, California, 5 September 2014
 Proc. SPIE 9208, Adaptive X-Ray Optics III, 920803 (2014)
 doi:10.1117/12.2060859

Burst-mode Femtosecond Non-collinear Parametric Amplifier with Arbitrary Pulse Selection

M. Pergament, M. Kellert, K. Kruse, J. Wang, G. Palmer, L. Wissmann, U. Wegner, M.J. Lederer
 CLEO: Science and Innovations, San Jose, California, 8–13 June 2014
 CLEO: 2014, OSA Technical Digest, STh4E.4 (2014)
 doi:10.1364/CLEO_SI.2014.STh4E.4

Dynamics of Laser Ion Acceleration at Temporal Resolution of the Laser Cycle

M. Schnuerer, A.A. Andreev, F. Abicht, J. Braenzel, C. Koschitzki, G. Priebe, W. Sandner, K.Y. Platonov
 High-Intensity Lasers and High-Field Phenomena (HILAS), Berlin, Germany, 18–20 March 2014
 Research in Optical Sciences (2014)
 ISBN: 978-1-55752-995-4
 doi:10.1364/HILAS.2014.HTh1B.3

European XFEL Construction Status

W. Decking, F. Le Pimpec
 36th International Free Electron Laser Conference 2014 (FEL2014), Basel, Switzerland, 25–29 August 2014
 Proceedings of FEL2014, Status of Projects and Facilities, WEB03 (2014)
 ISBN 978-3-95450-133-5

High Accuracy Shimming Technique for the Phase Shifters of the European XFEL

Y. Li, J. Pflueger

36th International Free Electron Laser Conference 2014 (FEL2014), Basel, Switzerland, 25–29 August 2014

Proceedings of FEL2014, FEL Technology and Hardware: Undulators, Magnets, Photon Diagnostics and Beamlines, Basel, MOP007 (2014)

ISBN 978-3-95450-133-5

High Energy/Intensity Lasers for HED Science at European XFEL

G. Priebe, M. Nakatsutsumi, I. Thorpe, B. Mueller, A. Pelka, K. Appel, T. Tschentscher, M. Lederer

Topical Problems of Nonlinear Wave Physics (NWP-2014), Nizhny Novgorod, Russia, 17–23 July 2014

Proceedings of NWP-2014, 119 (2014)

ISBN 978-5-8048-0099-5

Implementation Phase of the European XFEL Photon Diagnostics

J. Grünert, J. Buck, W. Freund, A. Koch, M. Planas, F. Dietrich

36th International Free Electron Laser Conference 2014 (FEL2014), Basel, Switzerland, 25–29 August 2014

Proceedings of FEL2014, FEL Technology and Hardware: Undulators, Magnets, Photon Diagnostics and Beamlines, MOP012 (2014)

ISBN 978-3-95450-133-5

Maia X-ray fluorescence imaging: Capturing detail in complex natural samples

C.G. Ryan, D.P. Siddons, R. Kirkham, Z.Y. Li, M.D. de Jonge, D.J. Paterson, A. Kuczewski, D.L. Howard, P.A. Dunn, G. Falkenberg, U. Boesenberg, G. De Geronimo, L.A. Fisher, A. Halfpenny, M.J. Lintern, E. Lombi, K.A. Dyl, M. Jensen, G.F. Moorhead, J.S. Cleverley, R.M. Hough, B. Godel, S.J. Barnes, S.A. James, K.M. Spiers, M. Alfeld, G. Wellenreuther, Z. Vukmanovic, S. Borg

22nd International Congress on X-Ray Optics and Microanalysis, Hamburg,

J. Phys.: Conf. Ser. 499, 012002 (2014)

doi:10.1088/1742-6596/499/1/012002

Non-negative factor analysis supporting the interpretation of elemental distribution images acquired by XRF

M. Alfeld, M. Wahabzada, C. Bauckhage, K. Kersting, G. Wellenreuther, G. Falkenberg

22nd International Congress on X-Ray Optics and Microanalysis, Hamburg, Germany, 2–6 September 2013

J. Phys.: Conf. Ser. 499, 012013 (2014)

doi:10.1088/1742-6596/499/1/012013

Perspectives for Imaging Single Protein Molecules with the Present Design of the European XFEL

G. Geloni, V. Kocharyan, E. Saldin, S. Serkez, I. Zagorodnov, O. Yefanov

36th International Free Electron Laser Conference 2014 (FEL2014), Basel, Switzerland, 25–29 August 2014

Proceedings of FEL2014, Seeded FELs, MOP082 (2014)

ISBN 978-3-95450-133-5

Proposal to Generate 10 TW Level Femtosecond X-ray Pulses from a Baseline Undulator in Conventional SASE Regime at the European XFEL

S. Serkez, V. Kocharyan, E. Saldin, I. Zagorodnov, G. Geloni
36th International Free Electron Laser Conference 2014 (FEL2014), Basel, Switzerland,
25–29 August 2014
Proceedings of FEL2014, SASE FELs, MOP057 (2014)
ISBN 978-3-95450-133-5

SASE Characteristics from Baseline European XFEL Undulators in the Tapering Regime

I. Agapov, G. Geloni, G. Feng, V. Kocharyan, E. Saldin, S. Serkez, I. Zagorodnov
36th International Free Electron Laser Conference (FEL2014), Basel, Switzerland,
25–29 August 2014
Proceedings of FEL2014, SASE FELs, MOP056 (2014)
ISBN 978-3-95450-133-5

SASE3: soft X-ray Beamline at European XFEL

D. La Civita, N. Gerasimova, H. Sinn, M. Vannoni
SPIE Optical Engineering + Applications, San Diego, California, 5 September 2014
Proc. SPIE 9210, X-Ray Free-Electron Lasers: Beam Diagnostics, Beamline Instrumentation,
and Applications II, 921002 (2014)
doi:10.1117/12.2061693

Simulations applied to focusing Optics at European XFEL

M. Sanchez del Rio, O. Chubar, L. Samoylova, H. Sinn
SPIE Optical Engineering + Applications, San Diego, California, 5 September 2014
Proc. SPIE 9209, Advances in Computational Methods for X-Ray Optics III, 920904
(2014)
doi:10.1117/12.2061692

Status of Pump-probe Laser Development for the European XFEL

L. Wissmann, M. Emons, M. Kellert, K. Kruse, M. Lederer, G. Palmer, M. Pergament,
G. Priebe, J. Wang, U. Wegner
Free Electron Laser Conference (FEL2014), FEL Technology and Hardware: Gun, RF, Lasers,
Basel, Switzerland, 25–29 August 2014
Proceedings of FEL2014, THP040 (2014)
ISBN 978-3-95450-133-5

Strategy of Technology Transfer of EXFEL Preparation Technology to Industry

A. Matheisen, J. Iversen, A. Schmidt, W. Singer, P. Michelato, L. Monaco
16th International Conference on RF Superconductivity (SRF 2013), Paris, France,
23–27 September 2013
Proceedings of SRF2013 (2014)
ISBN 978-3-95450-143-4

Storage Ring XFEL with Longitudinal Focusing

I. Agapov, G. Geloni

36th International Free Electron Laser Conference 2014 (FEL2014), Basel, Switzerland,
25–29 August 2014

Proceedings of FEL2014, Advanced, Alternative and Compact Concepts, TUP049 (2014)
ISBN 978-3-95450-133-5

Synchrotron Radiation Test Validations of European XFEL MCP-based Detectors at DORIS Beamline BW1

E. Syresin, A.Y. Grebentsov, A.V. Shabunov, N.I. Zamiatin, R. Basta, T. Fiala, P. Hedbavny,
O.I. Brovko, W. Freund, J. Gruenert, H. Sinn, D. Novikov, M. Yurkov,

5th International Particle Accelerator Conference (IPAC2014), Dresden, Germany,
15–20 June 2014

Proceedings of IPAC2014, WEPRO094 (2014)
ISBN: 978-3-95450-132-8

The Photon Beam Loss Monitors as a Part of Equipment Protection System at European XFEL

N. Gerasimova, H. Sinn, S. Dziarzhyski, R. Treusch

36th International Free Electron Laser Conference 2014 (FEL2014), Basel, Switzerland,
25–29 August 2014

Proceedings of FEL2014, FEL Technology and Hardware: Undulators, Magnets, Photon
Diagnostics and Beamlines, MOP010 (2014)

ISBN: 978-3-95450-133-5

X-ray Laminography and SAXS on Beryllium Grades and Lenses and Wavefront Propagation through Imperfect Compound Refractive Lenses

Th. Roth, L. Helfen, J. Hallmann, L. Samoylova, P. Kwaśniewski, B. Lengeler, A. Madsen
SPIE Optical Engineering + Applications, San Diego, California, 17 August 2014,

Proc. SPIE 9207, Advances in X-Ray/EUV Optics and Components IX, 920702 (2014)
doi:10.1117/12.2061127

X-ray Photon Temporal Diagnostics for the European XFEL

J. Liu, J. Buck, F. Dietrich, W. Freund, J. Grünert, M. Meyer

36th International Free Electron Laser Conference 2014 (FEL2014), Basel, Switzerland,
25–29 August 2014

Proceedings of FEL2014, FEL Technology and Hardware: Undulators, Magnets, Photon
Diagnostics and Beamlines, MOP014 (2014)

ISBN 978-3-95450-133-5 ■

ACKNOWLEDGEMENT

We would like to thank everyone who contributed to the creation of this annual report.
European X-Ray Free-Electron Laser Facility GmbH, May 2015

European XFEL Annual Report 2014**Published by**

European XFEL GmbH

Editor in chief

Massimo Altarelli

Managing editor

Bernd Ebeling

Copy editors

Kurt Ament

Ilka Flegel, Textlabor, Jena

Joseph W. Piergrossi

Image editor

Frank Poppe

Coordination

Joseph W. Piergrossi

Frank Poppe

Layout and graphics

blum design und kommunikation GmbH, Hamburg

Photos and graphs

Anton Barty, CFEL/DESY (p. 16); BINP, Novosibirsk (p. 76);

A. Ferrari, HZDR (p. 125); FHH, Landesbetrieb Geoinf. und Vermessung (aerial views pp. 20–21);

DESY, Hamburg (pp. 6, 12–13, 50–53, 60–61, 70–71, 77, 79, 80, 85–90, 92, 98, 184–185);

DTU, Kongens Lyngby (p. 10); EMBL-EBI, Hinxton, Cambridge (p. 152);

Ettore Zanon S.p.A., Schio (p. 80); JJ X-Ray, Lyngby (p. 78);

R. P. Kurta et al. (p. 106); PSI, Villigen (p. 78); University of Rostock (pp. 15, 46)

All others: European XFEL

Printing

Heigener Europrint GmbH, Hamburg

Available from

European XFEL GmbH

Notkestrasse 85

22607 Hamburg

Germany

+49 (0)40 8998-6006

contact@xfel.eu

www.xfel.eu/documents

Copy deadline

31 December 2014

www.xfel.eu

Copying is welcomed provided the source is acknowledged and an archive copy sent to the European XFEL GmbH.

